

Tam Tam

Design by Arter&Citton



archiproducts
DESIGN AWARDS
—
WINNER 2018





① Piano disponibile in diverse misure e forme.

② Disponibili diversi contenitori in acciaio e alluminio con moduli elettrici e/o multimediali. Disponibile con modulo passacavi (optional).

③ Ruota girevole con freno Ø 100 mm con supporto in poliammide e gomma termoplastica anti-traccia.

④ Gancio in acciaio ricoperto nylon nero per unione piani.

⑤ Perno di sicurezza.

⑥ Gamba in tubo d'acciaio a sezione ellittica 60x30 mm. Verniciatura opaca epossipoliestere a polveri.

① Table top available in different sizes and shapes.

② Several steel and aluminum containers available, with electrical and/or multimedia modules. Available with cable management module (optional).

③ Swivel castor with pedal brake Ø 100 mm, polyamide support and thermoplastic rubber.

④ Black nylon linking device to join tabletops.

⑤ Safety pin.

⑥ Elliptical steel tube leg 60x30 mm. Matt epoxy powder painting.

① Plateau disponible en différentes tailles et formes.

② Divers conteneurs en acier et en aluminium disponibles avec modules électriques et/ou multimédia. Disponible avec module passe-câbles (optionnel).

③ Roulette pivotante avec frein Ø 100 mm avec support en polyamide et caoutchouc thermoplastique anti-trace.

④ Crochet en acier recouvert nylon noir pour jonction des plateaux.

⑤ Goupille de sécurité.

⑥ Piètement en tube d'acier elliptique 60x30 mm. Vernis en poudre époxy-polyester.



Gancio in nylon grigio per unione piani (2 per tavolo). Solo per versione con angoli retti (RET) e forma a trapezio (TRA)

Grey linking device in nylon to join table tops (2 per table). Available only for table pops with straight angles (RET) and trapeze shape (TRA)

Crochet en nylon gris pour union des plateaux (2 par table). Disponible uniquement pour la version à angle droits (RET) et forme trapézoïdale (TRA).

AGG10

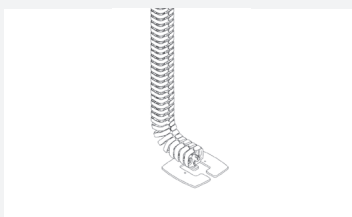
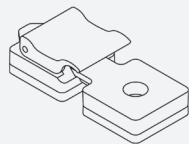
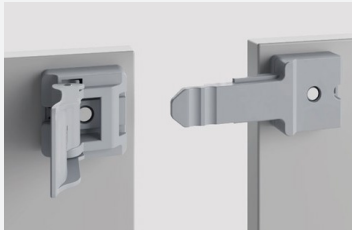

KIT13

Passacavi verticale flessibile. Struttura a vertebra in plastica con base in acciaio. Colore grigio RAL 7016.

KIT13

Flexible Cable guide. Polycarbonate vertebra frame with steel base. Color grey RAL 7016.

KIT13

Passe-câbles flexible. Structure en polycarbonate avec plaque en acier. Couleur grise RAL 7016.

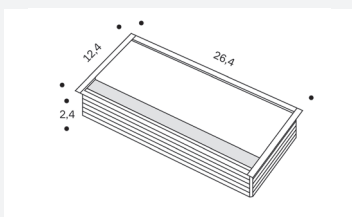

BOX07_A

Contenitore passacavi richiudibile in alluminio verniciato (Bianco RAL 9003, Nero RAL 9005, Grigio RAL 9006) con vassoio in lamiera zincata per la gestione dei cavi.

BOX07_A

Resealable aluminum painted cable management (White RAL 9003, Black RAL 9005 or Grey RAL 9006) with galvanized sheet metal tray for cable.

BOX07_A

Boîte refermable en aluminium verni pour passage câbles (Blanc RAL 9003, Noir RAL 9005 ou Gris RAL 9006) avec conteneur en tôle de zinc pour la gestion de les câbles.

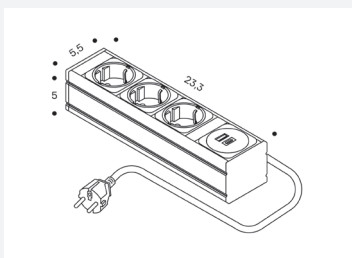
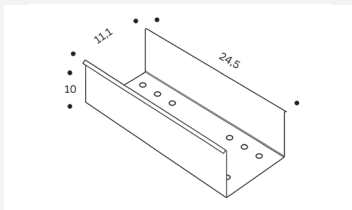

BOX08

Modulo multipresa in alluminio verniciato Nero RAL 9005, con cavo di alimentazione 2 m con spina maschio schuko.

BOX08

Multi-socket module in painted aluminum Black RAL 9005, with 2 m power cable with male Schuko plug.

BOX08

Module multiprise en aluminium verni Noir RAL 9005, avec câble d'alimentation de 2 m avec fiche Schuko mâle.

Prese elettriche

Sockets

Prises electriques



Schuko

Multimedia

Multimedia

Multimedia



USB charger (Type A+C)



HDMI



RJ45 (CAT6)

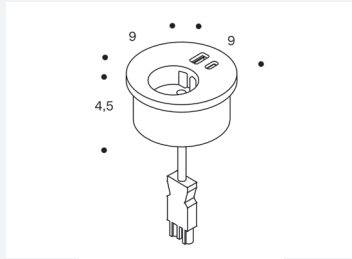

BOX09_A

Modulo singolo in tecnopolimero Nero con cover colorata* : 1x presa Schuko + 1x double USB charger (Type A+C). Versione da incasso, cavo di alimentazione con connettore GST.

Finiture Cover

Nero, Bianco, Verde, Azzurro, Giallo

BOX09_A

Single module in Black technopolymer with colored cover* : 1x Schuko socket + 1x double USB charger (Type A+C). Built-in version, power cable with GST connector.

Cover Finishes

Black, White, Green, Light Blue, Yellow

BOX09_A

Module unique en technopolymère Noir avec couvercle coloré* : 1x Schuko prise + 1x double USB charger (Type A+C). Version intégrée, câble d'alimentation avec connecteur GST.

Finitions Couvercle

Noir, Blanc, Vert, Bleu, Ciel, Jaune

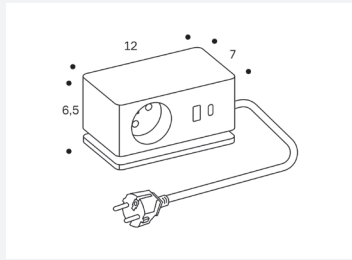

BOX10_A

Modulo singolo in tecnopolimero Nero o Bianco: 1x presa Schuko + 1x double USB charger (Type A+C). Versione con base in metallo, cavo di alimentazione 2 m con spina maschio schuko.

BOX10_A

Single module in Black or White technopolymer: 1x Schuko socket + 1x double USB charger (Type A+C). Metal base version, 2 m power cable with male Schuko plug.

BOX10_A

Module unique en technopolymère Noir ou Blanc: 1x Schuko prise + 1x double USB charger (Type A+C). Version avec base en métal, câble d'alimentation de 2 m avec prise Schuko mâle.

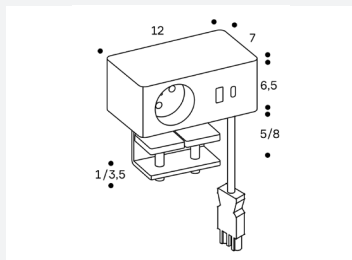

BOX10_B

Modulo singolo in tecnopolimero Nero o Bianco: 1x presa Schuko + 1x double USB charger (Type A+C). Versione con morsettiera, cavo di alimentazione con connettore GST18.

BOX10_B

Single module in Black or White technopolymer: 1x Schuko socket + 1x double USB charger (Type A+C). Version with terminal block, power cable with GST18 connector.

BOX10_B

Module unique en technopolymère Noir ou Blanc: 1x Schuko prise + 1x double USB charger (Type A+C). Version avec bornier, câble d'alimentation avec connecteur GST18.

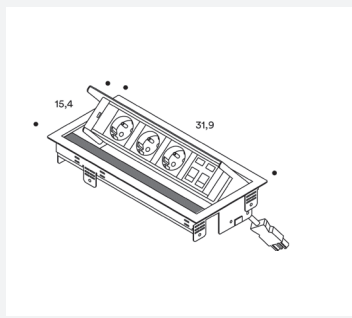

BOX02_B

Contenitore richiudibile in acciaio verniciato.

Finiture

Bianco RAL 9016
Nero RAL 9017
Grigio RAL 9006

4 moduli

- 3x prese elettriche uguali
- 2x RJ45

BOX02_B

Resealable painted steel box.

Finishes

White RAL 9016
Black RAL 9017
Grey RAL 9006

4 modules

- 3x same sockets
- 2x RJ45.

BOX02_B

Boîte en acier verni.

Finitions

Blanche RAL 9016
Noire RAL 9017
Grise RAL 9006

4 éléments

- 3 x mêmes prises électriques
- 2xRJ45.

Prese elettriche



Schuko



Schuko France



Schuko Italian (UNEL)



Danish



Swiss



British



American

Sockets

Prises électriques

Multimedia



Double USB charger (Type A+C)



USB 3.0 (Data)



HDMI



Mini Jack Stereo



RJ45 (CAT6)



VGA

Multimedia

Multimedia



CONNECTION CABLE

Cavo di connessione tra moduli elettrici 2-3 mt (H05W-F 3G 1.5 mm² / GST18-GST18).

CONNECTION CABLE

Connection cable to joint variable plug power supply system 2-3 mt (H05W-F 3G 1.5 mm² / GST18-GST18).

CONNECTION CABLE

Câble de connexion entre éléments électriques 2-3mt (H05W-F 3G 1.5 mm² / GST18-GST18).

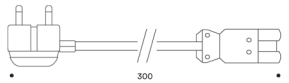

ELECTRIC CABLE

Cavo elettrico 2-3 mt (H05VV-F 3G 1.5 mm² / GST18-Spina Maschio).

ELECTRIC CABLE

Electric cable 2-3 mt (H05VV-F 3G 1.5 mm² / GST18-Male Plug).

ELECTRIC CABLE

Câble électrique 2-3 mt (H05W-F 3G 1.5 mm² / GST18-Prise mâle).

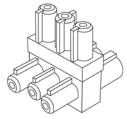
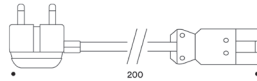

CAV_015

Distributore a 3 vie (Maschio/Maschio/Femmina).

CAV_015

Power distributor with 3 (Male/Male/Female).

CAV_015

Distributeur à 3 voies (Mâle/Mâle/Femelle).

Finiture

Finishes / Finitions

**FINITURE
PIANO**

**TABLE TOP
FINISHES**

**FINITIONS
PLATEAU**

**Truciolare rivestito Melaminico sp. 18 mm / MFC thk. 18 mm /
Agglomeré revêtu en Mèlaminé ép. 18 mm**



U12
Bianco
White
Blanc

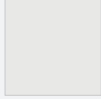

0FP
Grigio
Grey
Gris

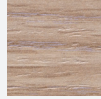

0ON
Rovere chiaro
Light Oak
Chêne Clair

**Truciolare rivestito Melaminico sp. 18 mm (FSC®) / MFC thk. 18 mm (FSC®) /
Agglomeré revêtu en Mèlaminé ép. 18 mm (FSC®)**



U12
Bianco
White
Blanc

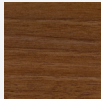

AS5
Noce Kiroso
Walnut Kiroso
Noyer Kiroso

**Truciolare rivestito Melaminico 3D sp. 18 mm / MFC 3D thk. 18 mm /
Agglomeré revêtu en Mèlaminé 3D ép. 18 mm**



ST37
Rovere Nat
Oak Nat
Chêne Nat



S075
Quercia Grigia
Grey Oak
Chêne Gris



S074
Quercia Bianca
White Oak
Chêne Blanc



S073
Quercia Miele
Honey Oak
Chêne Miel

**MDF Impiallacciato Legno sp. 19 mm [Solo TAMTAM 300120 CUR]
MDF Veneered Wood sp. 19 mm [Only TAMTAM 300120 CUR]
MDF plaqué Bois ép. 19 mm [Seulement TAMTAM 300120 CUR]**



12.96
Rovere Chiaro
Light Oak
Chêne clair

Truciolare rivestito Laminato Scrivibile sp. 20 mm (solo per Tam Tam 300120RET)
Chipboard covered in Writable Laminate thk. 20 mm (Only for Tam Tam 300120RET)
Aggloméré revêtu en Stratifié inscriptible ép. 20 mm (Seulement pour Tam Tam 300120RET)

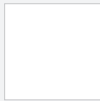

028 *
 Bianco
 White
 Blanc

*

Per il top con Laminato scrivibile non sono disponibili i BOX elettrici
 Electrical BOX not available with writable Laminate top
 Les BOX électriques ne sont pas disponibles pour les plateaux en Stratifié inscriptible

MDF laccato Perfect Sense sp. 18 mm / Lacquered MDF Perfect Sense thk. 18 mm /
MDF laqué Perfect Sense ép. 18 mm



U999
 Nero
 Black
 Noir

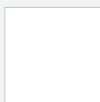

W1100
 Bianco
 White
 Blanc



U727
 Stone Grey



U961
 Graphite Grey



U604
 Reed Green

Multistrato betulla rivestito Linoleum sp. 20 mm / Birch plywood covered Linoleum thk. 20 mm /
Contreplaqué de bouleau revêtu Linoleum ép. 20 mm:



4178
 Iron



4175
 Pebble



4179
 Smoke Blue



4183
 Pistachio



4154
 Burgundy



4174
 Conifer

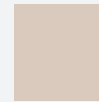

4185
 Powder

FINITURE STRUTTURA

FRAME FINISHES

FINITIONS STRUCTURE

Verniciato / Painted / Verni

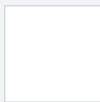

RAL 9003
 Bianco
 White
 Blanc
 Weiß



RAL 9006
 Grigio
 Grey
 Gris
 Grau

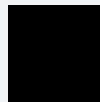

RAL 9005
 Nero
 Black
 Noir
 Schwarz

Verniciato (su richiesta) / Painted (on request) / Verni (Sur demande)



**34699 (similar
RAL 3016)**
 Corallo
 Coral
 Coral

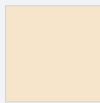

RAL 1015
 Avorio
 Ivory
 Ivoire



**PD6813 (similar
RAL 6028)**
 Verde scuro
 Dark green
 Vert foncé

Dimensioni Piano

Top Dimensions / Dimension du plateau

TAMTAM 240100

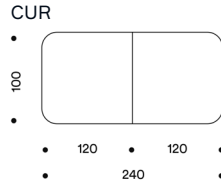
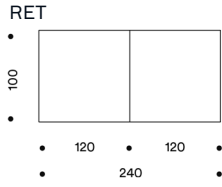

TAMTAM 240120

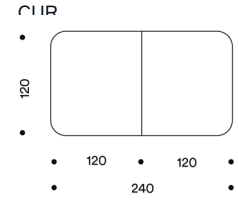
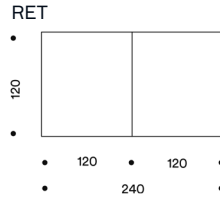

TAMTAM 260100

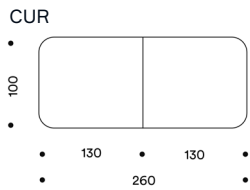
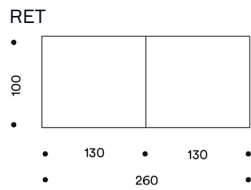

TAMTAM 280100

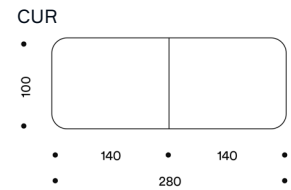
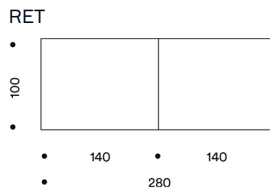

TAMTAM 260120

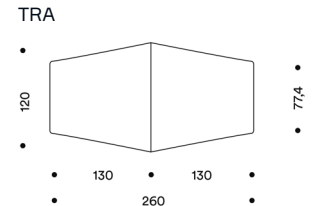
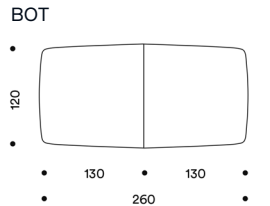
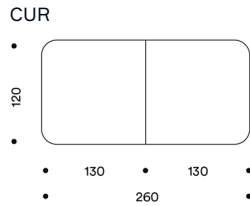
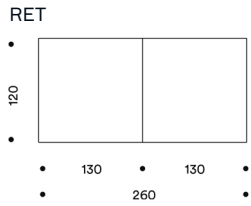

TAMTAM 280120

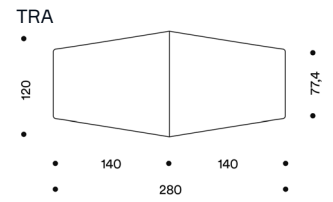
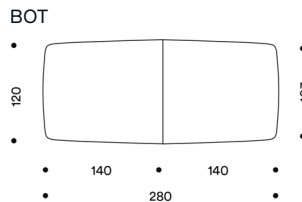
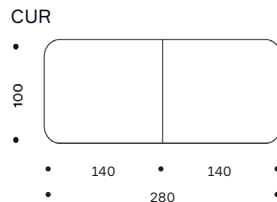
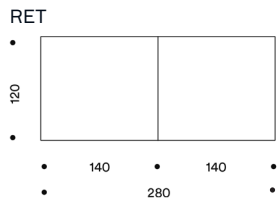

TAMTAM 300100

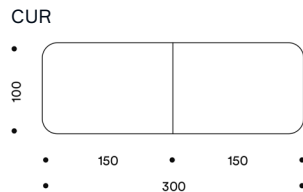
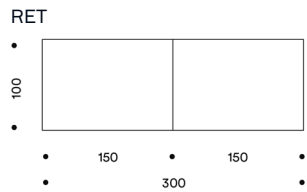

TAMTAM 320100

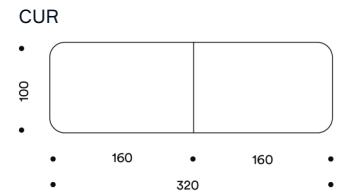
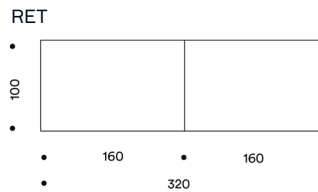

Dimensioni Piano

Top Dimensions / Dimension du plateau

TAMTAM 300120

RET

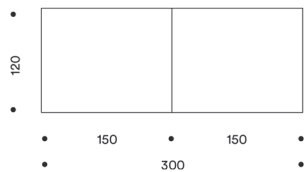

CUR

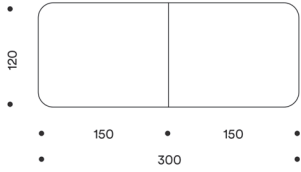

BOT

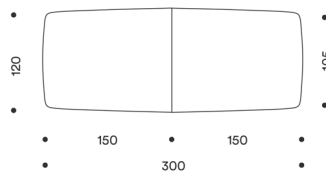

TRA

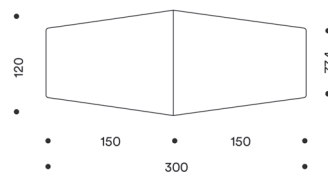

TAMTAM 320120

RET

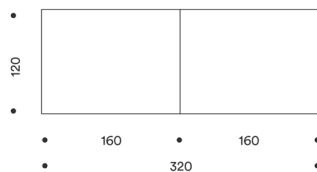

CUR

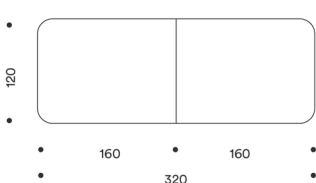

BOT

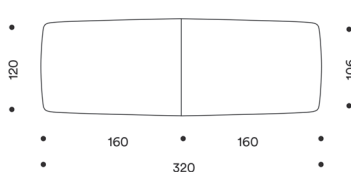

TRA

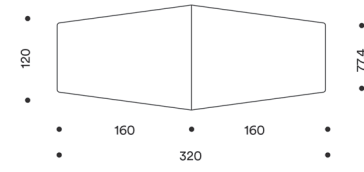

In fase di ordine specificare tipologia angoli dritti 90° o curvi R15.

When ordering specify angles type: straight 90° or curved R15.

En cours de commande préciser les angles droits 90° ou courbés R15.

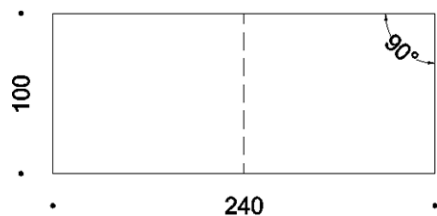

Disegni Tecnici

Technical Drawings / Dessins Technique

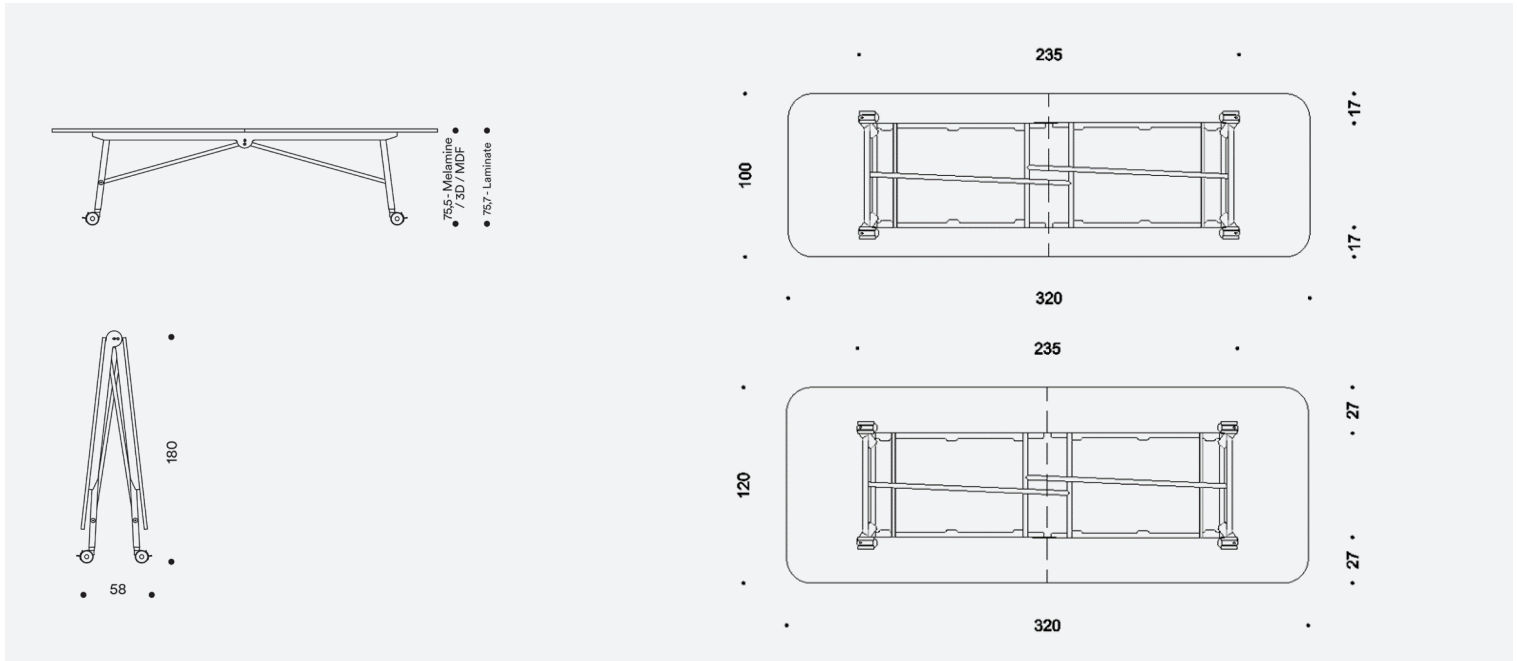

Composizioni

Compositions / Compositions

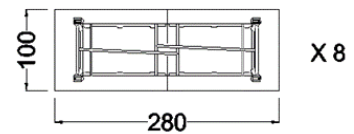
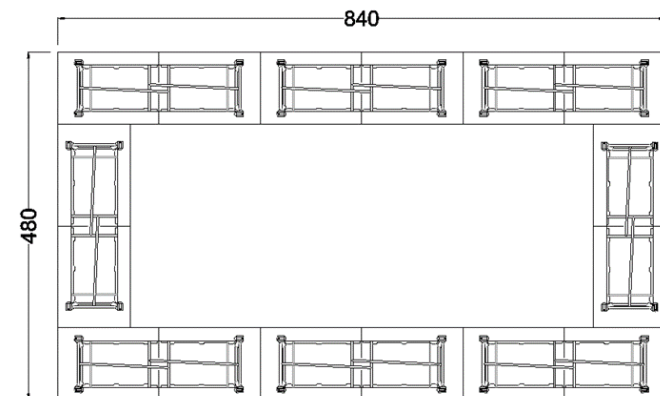
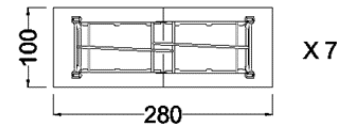
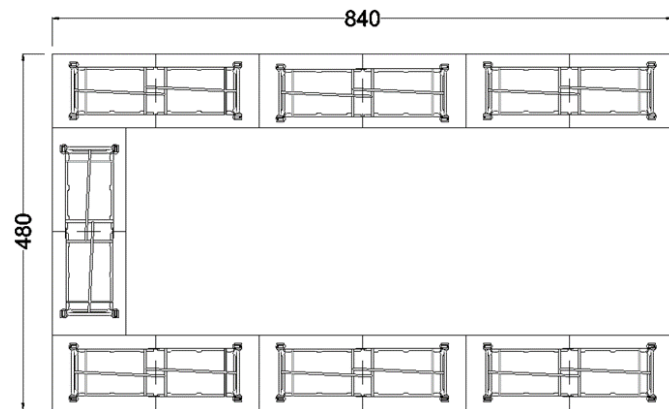

Sostenibilità

Sustainability / Durabilità

Disassemblabilità
del prodotto

- 1 Plastica
- 2 Metallo
- 3 Legno

Disassembly
of the product

- 1 Plastic
- 2 Metal
- 3 Wood

Démontage
du produit

- 1 Plastique
- 2 Métal
- 3 Bois

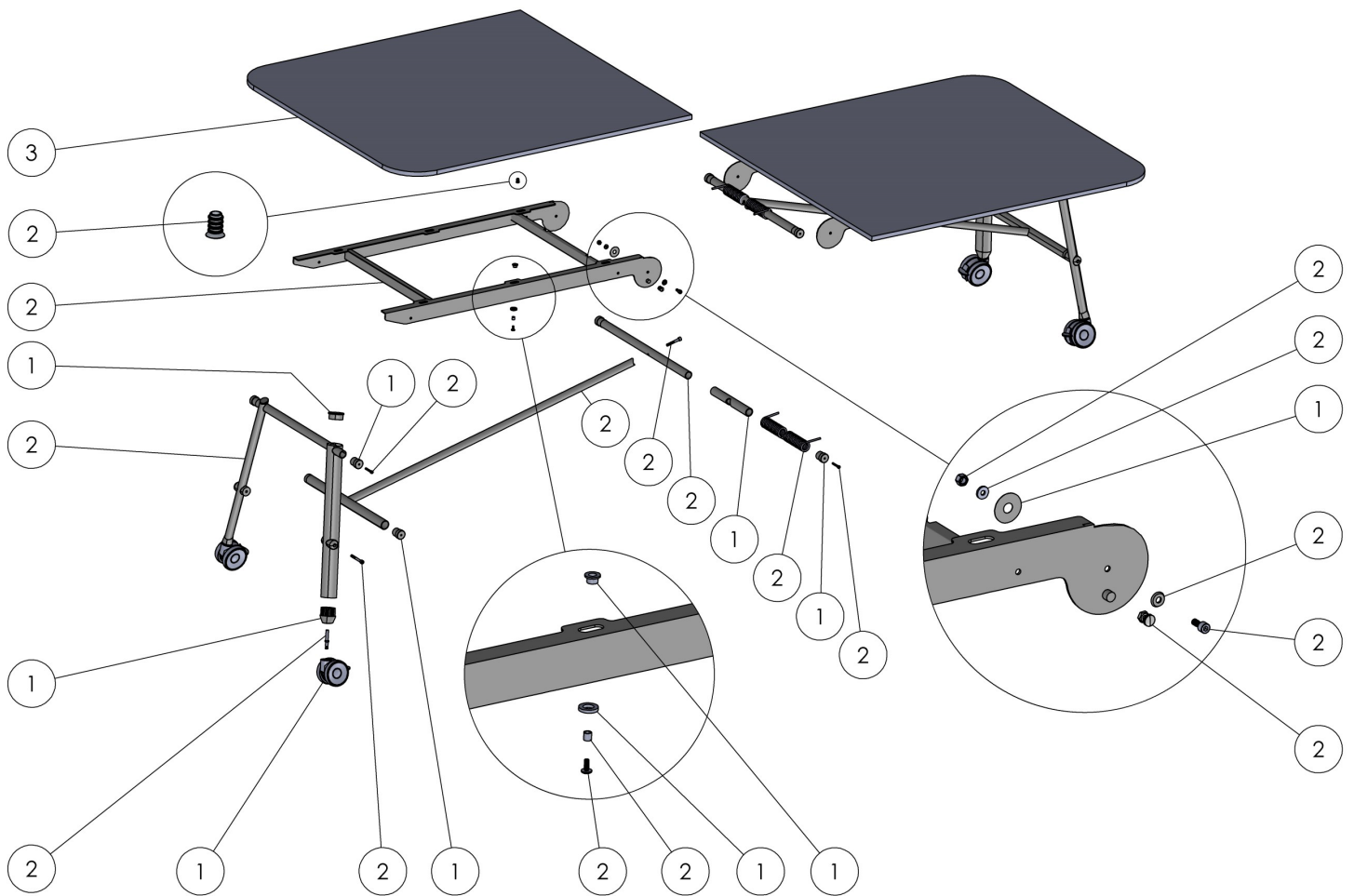

The mark of
responsible forestry

Prodotto disponibile su richiesta
Products available upon request
Produits disponibles sur demande

Sostenibilità

Sustainability / Durabilité / Nachhaltigkeit

PARTI METALLICHE

In conformità alla Direttiva 2011/617/UE sulla registrazione dell'uso di determinate sostanze pericolose nelle apparecchiature elettriche ed elettroniche (ROHS II), Direttiva delegata 2015/863/UE recante modifica dell'allegato II della Direttiva 2011/65/UE per quanto riguarda l'elenco delle sostanze con restrizioni d'uso (ROHS III) e Regolamento CE 1907/2006 concernente la registrazione, la valutazione, l'autorizzazione e la restrizione delle sostanze chimiche (REACH).

PARTI VERNICIATE

In conformità alla norma EN ISO 11890-2:2013, Pitture e vernici - determinazione del contenuto di composti organici volatili (VOC) - Parte 2.

IMBALLI

Provenienti da fornitori certificati che utilizzano materiali reperiti in modo responsabile.

RICICLABILITÀ DEL PRODOTTO

Una volta dismesso il prodotto non deve essere disperso nell'ambiente. Prodotto riciclabile separando i componenti.

METAL PARTS

Certification of compliance in accordance with Directive 2011/617/UE on the restriction of the use of certain hazardous substances in electrical and electronic equipment (ROHS II), delegated Directive 2015/863/UE amending Annex II to Directive 2011/65/UE concerning the list of restricted substances (ROHS III) and Regulation No 1097/2006 concerning the Registration, Evaluation, Authorisation and Restriction of Chemicals (REACH).

PAINTED PARTS

Certification of compliance in accordance with EN ISO 11890-2:2013, Paints and varnishes - Determination of volatile organic compound (VOC) content — Part 2

PACKAGING

From suppliers certified who use responsibly sourced materials.

RECYCLING OF THE PRODUCT

Once decommissioned, avoid release into the environments. Recyclable product separating its components.

PIÈCES MÉTALLIQUES

Conformément à la directive 2011/617/UE sur l'enregistrement de l'utilisation de certaines substances dangereuses dans les équipements électriques et électroniques (ROHS II), directive déléguée 2015/863/UE modifiant l'annexe II de la directive 2011/65/UE en ce qui concerne la liste des substances soumises à restrictions d'utilisation (ROHS III) et règlement CE 1907/2006 concernant l'enregistrement, l'évaluation, l'autorisation et la restriction des substances chimiques (REACH).

PARTI VERNIS

Conformément à la norme EN ISO 11890-2:2013, Peintures et vernis - détermination de la teneur en composés organiques volatils (COV) - Partie 2.

EMBALLAGES

De fournisseurs certifiés qui utilisent des matériaux provenant de sources responsables.

RECYCLABILITÉ DU PRODUIT

Une fois le produit retiré, il ne doit pas être dispersé dans l'environnement. Produit recyclable en séparant les composants.

Consegna rapida

Fast Delivery / Livraison Rapide / Schnelle Lieferung

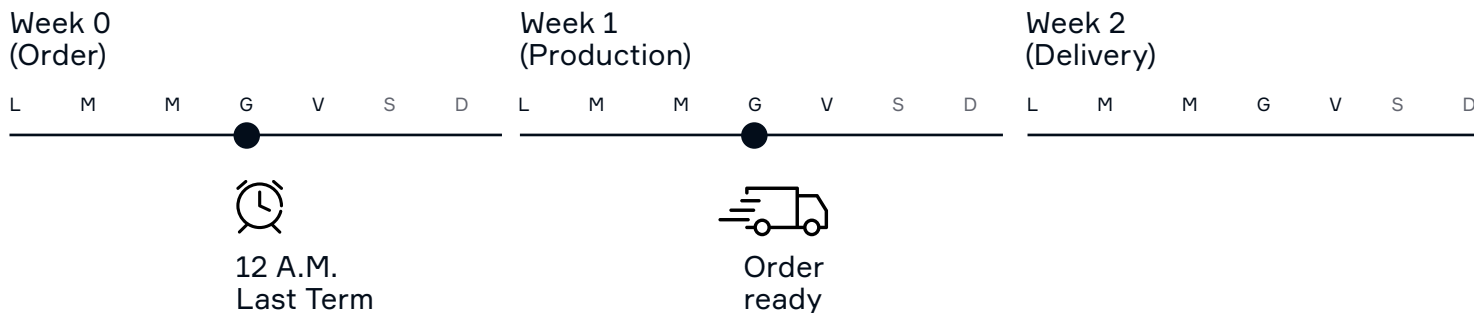

Disponibile solo per tavoli senza moduli elettrici e/o multimediali.

Disponibile solo per tavoli con piano in Melaminico, Melaminico FSC® (Disponibile su richiesta), Melaminico 3D e MDF PerfectSense.

Available only for tables without electricity and/or multimedia modules.

Available only for tables with MFC, MFC FSC® (available upon request), MFC 3D and MDF PerfectSense tabletops.

Disponibile uniquement pour table sans éléments électriques et/ou multimédia.

Disponible exclusivement pour tables avec plateau en Méla mine, Méla mine FSC® (disponibles sur demande), Méla mine 3D et MDF PerfectSense.

Note

Notes / Note

Pulizia

Per le parti metalliche consigliamo esclusivamente un panno morbido e alcool asciugando bene dopo la pulizia. Per le superfici in plastica, usare panno umido ed acqua con detersivo liquido neutro, non usare solventi, trielina, acetone o ammoniaca.

Cleaning

For the metal parts we recommend only a soft cloth and alcohol, drying well after cleaning. For plastic surfaces, use a damp cloth and water with neutral liquid detergent, do not use solvents, trichlorethylene, acetone or ammonia.

Nettoyage

Pour les parties métalliques, nous recommandons uniquement un chiffon doux et de l'alcool, bien sécher après le nettoyage. Pour les surfaces en plastique, utilisez un chiffon humide et de l'eau avec un détergent liquide neutre, n'utilisez pas de solvants, de trichloréthylène, d'acétone ou d'ammoniac.

Garanzia

I nostri prodotti sono garantiti 5 anni (testo integrale della garanzia su richiesta). Un uso improprio del prodotto preclude la garanzia dello stesso.

Warranty

Our products are guaranteed for 5 years (full text of the guarantee on request). Improper use of the product precludes its warranty.

Garantie

Nos produits sont garantis 5 ans (texte complet de la garantie sur demande). Une mauvaise utilisation du produit exclut sa garantie.

Uso improprio

Non sono consentiti: Modifiche strutturali e/o manomissioni al prodotto.

Improper use

The following are not allowed: Structural changes and / or product tampering.

Utilisation incorrecte

Les éléments suivants ne sont pas autorisés : Modifications structurelles et/ou altération du produit.