

Gaber®

Prisliste 2022

CONTENTS / INDICE CHAIRS

DAME P.96

Forsix Design



CUCARACHA P.93

Favaretto & Partners Design

[NEW]



MANAA P.164

Studio Eurolinea Design



CHOPPY P.79 CHEVALET P.78

Favaretto & Partners Design

Favaretto & Partners Design



NUTA LIGHT P.182 KASIA P.157

Favaretto & Partners Design

[NEW] Forsix Design

[NEW]



CHAIRS

FULLER

Marc Sadler Design



P.118 ARTESIA

Forsix Design



P.62

[NEW]

JUBEL

Forsix Design



P.126

KANVAS

Stefano Sandonà Design



P.135

EPICA

Marc Sadler Design



P.108 TOGETHER

Marc Sadler Design



P.215 LILÁ

Forsix Design



P.160

NUTA

Favaretto & Partners Design



P.180 ABUELA

Favaretto & Partners Design



P.44

CHAIRS

ISIDORA

Favaretto & Partners Design



P.124 LILIBET

Forsix Design



P.161

[NEW]

SPYKER

Studio Eurolinea Design



P.210 CLIPPERTON

Marc Sadler Design



P.82

BAKHITA

Studio Eurolinea Design



P.66 MINUSH

Studio Eurolinea Design



P.226 PRISMA

Studio Eurolinea Design



P.196

SANELA

Forsix Design



P.198

[NEW]

AMITHA

Forsix Design



P.58

[NEW]

CHAIRS

LINK

Stefano Sandonà Design



KALIPA

Studio Eurolinea Design



P.134 PANAMA

Stefano Sandonà Design



P.185 BIG BANG

Stefano Sandonà Design



BLOG

Stefano Sandonà Design



P.76 AKAMI

Stefano Sandonà Design



P.46

COLORFIVE

Stefano Sandonà Design



P.85 ALHAMBRA

Stefano Sandonà Design



P.53

SLOT

Favaretto & Partners Design



P.201

CHAIRS

BASKET

Forsix Design



P.68 MOEMA

Forsix Design



P.170

MORE

Favaretto & Partners Design



ELODIE

Marc Sadler Design



P.106 TECKEL

Studio Eurolinea Design



P.175 EXTREME

Forsix Design

P.114 FLAP

Studio Eurolinea Design



P.213 NINJA

Delineo Design

P.116 COMPACT

Studio Eurolinea Design



P.179 PRODIGE

Delineo Design

P.90

HARMONY

Studio Eurolinea Design



P.121 IRIS

Studio Eurolinea Design



P.123 MOON - VENEZIA

Forsix Design



P.174 - 217

OVER

Forsix Design



P.184 LIBERTY

Forsix Design



P.159 OPEN

Forsix Design



P.183 SERENA

Forsix Design



P.200

CHAIRS

MAYA

Forsix Design



P.168 TULIP

Forsix Design



P.216 BEVERLY

Forsix Design



P.74

LOUNGE SEATING, SOFAS, POUF

SANELA

Forsix Design



P.198

[NEW]

AMITHA

Forsix Design



P.60

[NEW]

LINK

Stefano Sandonà Design



P.162 SUNLOUNGER

Forsix Design



P.211

LOUNGE SEATING, SOFAS, POUF

MINUSH RELAX

P.169

GRAND MINUSH

P.120 CONGA

P.91

Studio Eurolinea Design

Studio Eurolinea Design

Studio Eurolinea Design



ETESIAN

Forsix Design

P.110

[NEW]



SOCIAL-IZE

P.209

PANKY

P.187

Studio Eurolinea Design

Forsix Design



PLACE

Favaretto & Partners Design

P.193



EALA

Forsix Design

P.104 KANVAS LOUNGE

[NEW] Stefano Sandonà Design

P.156



LOUNGE SEATING, SOFAS, POUF

SLOT LOUNGE

Favaretto & Partners Design

P.208 ABUELA LOUNGE

P.45

Favaretto & Partners Design



CUCARACHA

Favaretto & Partners Design

P.93 FINFERLO

P.115

[NEW] Favaretto & Partners Design



STOOLS

NUTA LIGHT

Favaretto & Partners Design



P.272 KASIA

[NEW] Forsix Design



P.257

[NEW]



SANELA

Forsix Design



P.281 AMITHA

[NEW] Forsix Design



P.227 LINK

Stefano Sandonà Design



P.262



ABUELA

Favaretto & Partners Design



P.220 NUTA

Favaretto & Partners Design



P.271



ISIDORO

Favaretto & Partners Design



P.247 BAKHITA

Studio Eurolinea Design



P.231 SPYKER

Studio Eurolinea Design



P.288



FULLER

Marc Sadler Design



P.245 JUBEL

Forsix Design



P.250



STOOLS

KANVAS

Stefano Sandonà Design



P.254 ARTESIA

Forsix Design



P.228



COLORFIVE

Stefano Sandonà Design



P.235 ALHAMBRA

Stefano Sandonà Design



P.223 PRODIGE

Delineo Design



P.278

BLOG

Stefano Sandonà Design



P.232 AKAMI

Stefano Sandonà Design



P.221 MOEMA

Stefano Sandonà Design



P.268

[NEW]



MORE

Favaretto & Partners Design



P.269 MANAA

Studio Eurolinea Design



P.263 DAME

Forsix Design



P.238

[NEW]



SLOT

Favaretto & Partners Design



P.283 PANAMA

Stefano Sandonà Design



P.276 KALIPA



Studio Eurolinea Design



P.253



STOOLS

EASY	P.240	LILÁ	P.260	SHIVER	P.282	ROLLER	P.280		
Studio Eurolinea Design	Forsix Design		Studio Eurolinea Design		Studio Eurolinea Design				
									
MOEMA	P.267	OCTO	P.273	FREEDOM	P.244	RITMO	P.279	FORMAT	P.242
Stefano Sandonà Design	Stefano Sandonà Design		Stefano Sandonà Design		Forsix Design		Forsix Design		
									
MAX	P.265	CROSS	P.237	SWING - TORINO	P.290 - 292	SQUARE	P.289		
Forsix Design	Forsix Design		Stefano Sandonà Design		Forsix Design				
									
MICRO	P.266	OVER	P.275	ASOLO	P.230	SNACK · CITRO	P.287-234		
Studio Eurolinea Design	Forsix Design		Forsix Design		Forsix Design				
									
FIX · TOM · JOY	P.241-291-249				GULIVER · FREE	P.246-243			
Studio Eurolinea Design					Forsix Design				
									

STOOLS

LIBERTY

P.259 OFER

P.274

Forsix Design

Forsix Design



TABLES

COFFEE TABLES_H35/50

<u>TAG</u>		<u>P.357</u>	<u>SURFY</u>		<u>P.355</u>	<u>SURFY</u>		<u>P.356</u>
Ilaria Marelli Design		[NEW]	Studio Eurolinea Design			Studio Eurolinea Design		



<u>STEFANINO</u>	<u>P.345</u>	<u>STEFANO 3-POD</u>	<u>P.344</u>	<u>WOODY</u>	<u>P.361</u>	<u>SATURNINO</u>	<u>P.339</u>	<u>ROLLER</u>	<u>P.333</u>
Studio Eurolinea Design		Studio Eurolinea Design		Favaretto & Partners Design		Studio Eurolinea Design		Studio Eurolinea Design	



<u>ARKET</u>	<u>P.296</u>	<u>LOL3</u>	<u>P.318</u>	<u>LINK</u>	<u>P.317</u>	<u>SIMPLY</u>	<u>P.340</u>	<u>MINUSH</u>	<u>P.322</u>
Studio Eurolinea Design		Forsix Design		Stefano Sandonà Design		Studio Eurolinea Design		Studio Eurolinea Design	



<u>CLARO</u>	<u>P.303</u>	<u>CLARO SLIM</u>	<u>P.306</u>
Studio Eurolinea Design		Studio Eurolinea Design	



TABLES

HIGH TABLES_H100/110

SURFY HIGH DESK 2027 P.353 STEP P.346 FORMAT P.310 BASKET P.300 ICS P.315

Studio Eurolinea Design Studio Eurolinea Design Studio Eurolinea Design Studio Eurolinea Design Studio Eurolinea Design



AZIONE P.299 CLARO SLIM P.308 SIMPLY P.340 TOGETHER P.360 NORMAN P.324

Forsix Design Studio Eurolinea Design Studio Eurolinea Design Marc Sadler Design Forsix Design [NEW]



GLITTER P.311 ARKET P.296 LEI P.400 TKITT P.363 TATAMI P.409

Forsix Design [NEW] Studio Eurolinea Design Studio Eurolinea Design Studio Eurolinea Design Studio Eurolinea Design



SERIE R P.403 - 404 SERIE Q P.405 - 406 ROLLER P.336

Studio Eurolinea Design Studio Eurolinea Design Studio Eurolinea Design



TABLES

TABLES_H74

APRIO	P.295	CLARO	P.303	CLARO SLIM	P.307
Forsix Design	[NEW]	Studio Eurolinea Design		Studio Eurolinea Design	



SIMPLY	P.340	ROLLER	P.336	MUG	P.323	SATURNO	P.338	TKITT	P.363
Studio Eurolinea Design		Studio Eurolinea Design		Studio Eurolinea Design		Studio Eurolinea Design		Studio Eurolinea Design	



GLITTER	P.311	ARKET	P.296	ARKET PLUS	P.298
Forsix Design	[NEW]	Studio Eurolinea Design		Studio Eurolinea Design	



BRISTOL	P.301	LOL	P.318	LOL PLUS	P.319
Forsix Design	[NEW]	Forsix Design		Forsix Design	



LEI	P.213	HUG	P.312	AMICA	P.215	NORMAN	P.324	LOGIN	P.317
Studio Eurolinea Design		Studio Eurolinea Design		Studio Eurolinea Design		Forsix Design	[NEW]	Studio Eurolinea Design	



TABLES

TABLES_H74

PAREO	P.327	AGILE	P.294	CHARME	P.302
Studio Eurolinea Design	[NEW]	Studio Eurolinea Design		Studio Eurolinea Design	



SURFY HUB 2027	P.348	SURFY DESK 2027	P.352	SURFY HUB 2027 OVAL	P.350
Forsix Design		Forsix Design		Forsix Design	



FLIPAWAY	P.309	AZIONE	P.299	FORMAT	P.310	PROFILO	P.332	SPACE	P.341
Forsix Design		Forsix Design		Studio Eurolinea Design		Studio Eurolinea Design		Studio Eurolinea Design	



STEFANO	P.342	TOGETHER	P.359
Studio Eurolinea Design		Marc Sadler Design	



TABLES

TKITT COLLECTION

TKITT.BG3K P.365 TKITT.BG3L P.366 TKITT.BG4IP P.369 TKITT.BG4J P.368 TKITT.BG4K P.367



TKITT.BGA3L P.366 TKITT.BGA4K P.367 TKITT.BGPJ P.369 TKITT.BGPK P.368 TKITT.DPBT54 P.372



TKITT.BQAJ P.373 TKITT.BQJ P.373 TKITT.BRK P.372 TKITT.BTAK P.370 TKITT.BTAK54 P.371



TKITT.BTK P.370 TKITT.BTK54 P.371 TKITT.STAKY P.374 TCONT.STADY P.375



TABLES

TABLE TOPS

STANDARD COMPACTOP SURFACES P.376 SPECIAL COMPACTOP SURFACES FULLCOLOR P.377 SPECIAL COMPACTOP SURFACES 10 P.378 SPECIAL COMPACTOP SURFACES FENIX P.380 STANDARD LAMINATED SURFACES 22 P.381



STANDARD LAMINATED SURFACES 50 P.382 SPECIAL LAMINATED SURFACES WOOD EFFECT 25 P.383 SPECIAL LAMINATED SURFACES FENIX 25 P.384 IRON SURFACES P.385 TECHNO POLYMER TABLE TOPS P.386



TABLES

TABLE BASES COLLECTION

ALFIE P.408 AMICA P.402 ARKET PLUS P.389 ARKET 3 P.388



ARKET 4 P.388 BG2J P.395 BG3K - BGA3K P.389 - 390 BG3L - BGA3L P.391



BG4IP P.395 BG4J P.393 BG4K - BGA4K P.392 BGPJ P.394 BGPK P.393



BPG3K P.390 BPG4K P.394 BQAJ - BQJ P.400 - 401 BRCV P.398 BRISTOL P.413



[NEW]

BRK P.399 BTAK - BTK P.396 BTAK54 - BTK54 P.397 D2 P.407 GLITTER P.414



[NEW]

TABLES

TABLE BASES COLLECTION

LEI P.400 LOL PLUS P.412 LOL 3 P.410 LOL 4 P.411



Q1 - Q2 - Q3

P.405 - 406 R1 - R2 - R3

P.403 - 404



T1 FLOOR FIXING

P.405 TATAMI

P.409 V1

P.404 VENUS ROUND

P.398 VENUS SQUARE

P.399



CABINETS & WORKSTATION

OFFICE & WORKSPACES SYSTEMS

WORKSTATIONS 2027

P.416

Forsix Design

[NEW]



CABINETS 2027

P.424

Forsix Design

[NEW]



ACOUSTIC & ACCESSORIES

DIAMANTE

Studio Eurolinea Design



P.437 TUNE

Forsix Design



P.444 PIUMA

Studio Eurolinea Design



P.442

STILLY

Studio Eurolinea Design



P.432 FONO

Marc Sadler Design

P.433

MADISON

Studio Eurolinea Design



P.436 UNIKO

Studio Eurolinea Design



P.435

ONDA

Studio Eurolinea Design



P.448 FLAIRE

Studio Eurolinea Design



P.450 LUX

Studio Eurolinea Design



P.451 CULTURE

Malene Flensted
Urup Design



P.449 DISPLAY

[NEW] Malene Flensted
Urup Design



P.429

COLORS AND FINISHES P.454



AWARDS

SUCCESS IN PROGRESS

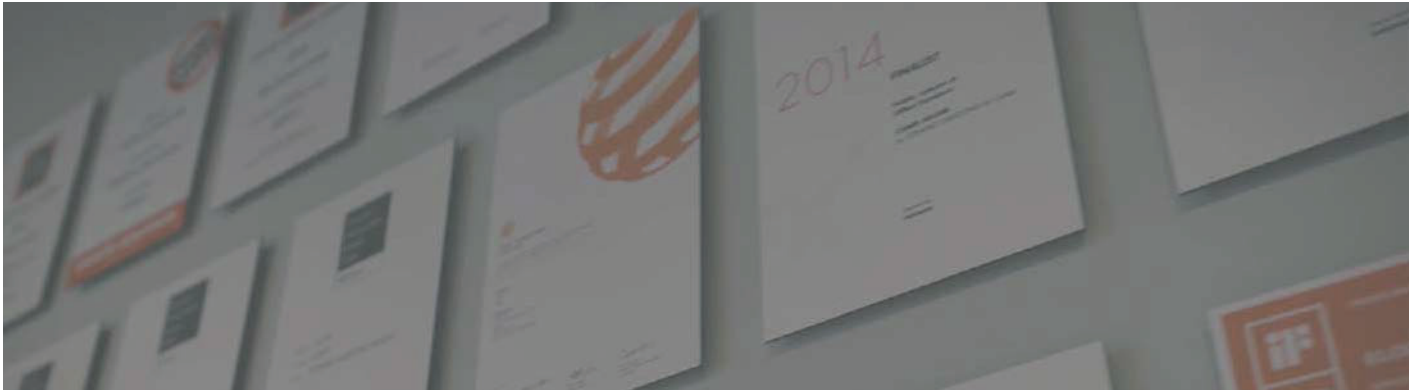

Gaber has won prestigious awards in the field on innovation and design. These recognitions are a testament to Gaber's unstinting commitment to design and the focus on originality and innovation we bring to the world.

Gaber ha vinto prestigiosi riconoscimenti nel campo dell'innovazione e del design. Questi riconoscimenti sono una testimonianza dell'impegno incondizionato di Gaber per il design e l'attenzione all'originalità e all'innovazione che portiamo al mondo.



MAGIC
2003
Studio Eurolinea
Design



OVER
2004
Studio Eurolinea
Design



PRISMA
2005
Studio Eurolinea
Design



PRODIGE
2007
Delineo Design



FLOWER
2008
Laura Tombari
Design

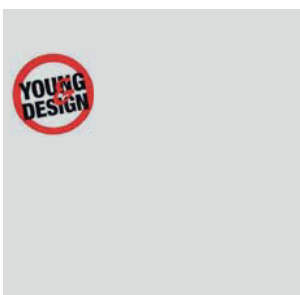

SPRING
2008
Monica Graffeo
Design



EXTREME
2009
Stefano Sandonà
Design



MOEMA
2009
Stefano Sandonà
Design



AWARDS



ALHAMBRA
2010
Stefano
Sandonà
Design



FREEDOM
2010
Stefano
Sandonà
Design

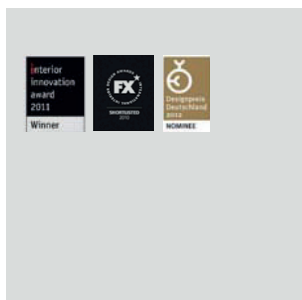

BIG BANG
2011
Stefano Sardonà
Sabrina Bettini
Design



MOEMA wood
2011
Stefano
Sandonà
Design

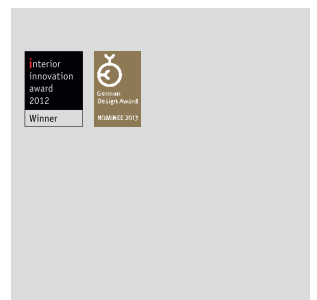

JOE
2011
Stefano
Sandonà
Design



COLORFIVE
2011
Stefano
Sandonà
Design



TOGETHER
2011
Marc Sadler
Design



BLOG
2012
Stefano
Sandonà
Design

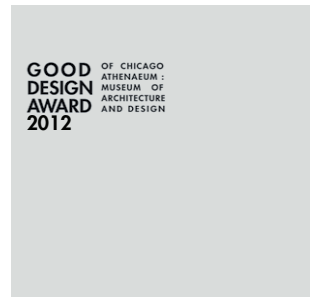

OCTO
2012
Stefano
Sandonà
Design



MORE
2012
Favaretto &
Partners
Design



PANAMA
2013
Stefano
Sandonà
Design



AKAMI
2013
Stefano
Sandonà
Design



SUCCESS IN PROGRESS



SLOT
2013
Favaretto & Partners Design



CHEVALET
2013
Favaretto & Partners Design



BASKET
2013
Alessandro Busana Design



EPICA
2014
Marc Sadler Design



STILLY
2014
Studio Eurolinea Design



ISIDORA
2015
Favaretto & Partners Design



CHOPPY
2015
Favaretto & Partners Design

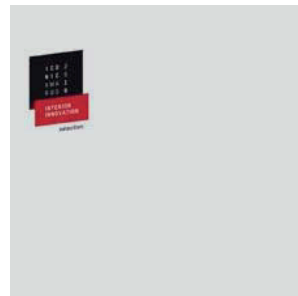

AVENICA
2016
Studio Eurolinea Design



PLACE
2016
Favaretto & Partners Design



DIAMANTE
2016
Studio Eurolinea Design



ELODIE
2016
Marc Sadler Design



CLIPPERTON
2017
Marc Sadler Design



AWARDS



ABUELA
2018
Favaretto &
Partners Design



SPYKER
2018
Studio Eurolinea
Design

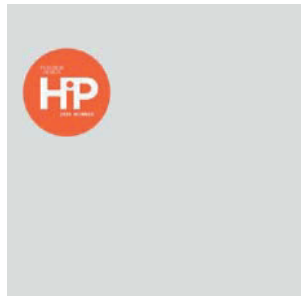

JUBEL
2019
Forsix Design



FULLER
2019
Marc Sadler
Design



CUCARACHA
2019
Favaretto &
Partners Design



SUNLOUNGER DOGE
2019
Forsix Design



NUTA
2019
Favaretto &
Partners Design



AMITHA
2021
Forsix Design



ARTESIA
2021
Forsix Design



SEATING Collection

Abuela



Available colors / Colori disponibili

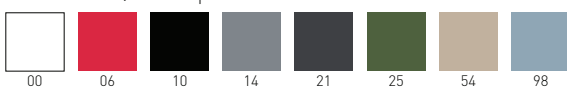

ABUELA



4-legged stackable techno-polymer chair.
Sedia impilabile in tecnopolimero.

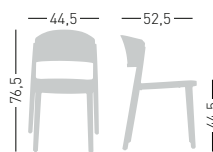

stackable / impilabile (6pcs)
A assembled / assemblato



0,43 m³ - 16,8 kg.
59x75x99cm.
4 pcs [carton]

Frame Finishing & Codes / Finiture Telai e Codici

cod.292.--/A

DKK - kr

995

ABUELA B



4-legged stackable techno-polymer chair with armrests.
Sedia impilabile in tecnopolimero con braccioli.

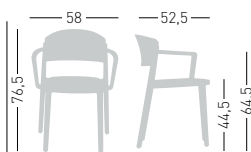

stackable / impilabile (6pcs)
A assembled / assemblato



0,43 m³ - 19,2 kg.
59x75x99cm.
4 pcs [carton]

Frame Finishing & Codes / Finiture Telai e Codici

cod.293.--/A

DKK - kr

1.095

ABUELA
CUSHION / CUSCINO



Upholstered cushion.
Cuscino tappezzato.

Available fabric.
Tessuti disponibili.
K, B, E, DK, TC



0,5 kg.
Inside chairs
boxes
Nella scatola
delle sedie.

Frame Finishing & Codes / Finiture Telai e Codici

cod.321.-- (K)
cod.321.-- (E)
cod.321.-- (B)
cod.321.-- (DK)
cod.321.TC COM fabric/tessuto cliente

DKK - kr

500
500
550
625
450

Minimum order 4pcs each code
Ordine minimo 4 pezzi per codice

COM fabric minimum order 10pcs each code
Tessuto cliente TC ordine minimo 10pz per codice

Fabric required / Fabbisogno di tessuto
4 pcs : Lin Mtrs 1 (h1,40)

ABUELA UPHOLSTERED IMBOTTITE

Available fabric / Tessuti disponibili
King fabric / Tessuto King **K** (20pcs min.)
Kvadrat fabrics / Tessuti Kvadrat - Remix 3 **DK** (20pcs min.)

Steelcut 2 Fabric not available on this product
Tessuto Steelcut 2 non disponibile per questo prodotto

ABUELA WOOD



F

Upholstered chair,
wooden beech frame.
Poltroncina rivestita,
telaio in legno di faggio.



A assembled / assemblato



0,37 m³ - 8 kg.
79x57x82cm.
1 pcs [carton]

Frame Finishing & Codes / Finiture Telai e Codici

cod.295.--/IKBLF
cod.295.--/IDKBLF

DKK - kr

6.995
7.495

Felt Glides / Tappi in feltro

Minimum order 20 pcs each code
Ordine minimo 20 pezzi per codice

**ABUELA LOUNGE
WOOD**



F

Upholstered lounge chair,
wooden beech frame.
Poltrona rivestita,
telaio in legno di faggio.



A assembled / assemblato



0,71 m³ - 10 kg.
83x90x95cm.
1 pcs [carton]

Frame Finishing & Codes / Finiture Telai e Codici

cod.296.--/IKBLF
cod.296.--/IDKBLF

DKK - kr

9.995
10.995

Felt Glides / Tappi in feltro

Minimum order 20 pcs each code
Ordine minimo 20 pezzi per codice

Akami



Available colors / Colori disponibili

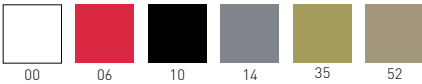

IGN Versions follows UNI 9177 certification in terms of Fire Resistance, Fire Reaction Class 1
Versioni IGN prodotto Omologato con Classe di Reazione al fuoco 1, UNI 9177



AKAMI NA



Chromed or painted 4-Legged metal frame, techno-polymer shell.
Struttura in metallo 4 gambe, cromata o verniciata, scocca in tecnopolimero.



only for painted frames
solo per telai verniciati

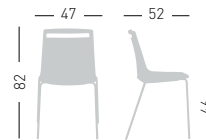

stackable / impilabile (5pcs)
NA not assembled / non assemblato



0,25 m³ - 19,8 kg.
67x56x64,5cm.
4 pcs [carton]

Frame Finishing & Codes / Finiture Telai e Codici

cod.191.--/NA chromed/cromata
cod.191.--/NAB white painted/verniciato bianco
cod.191.--/NAN black painted/verniciato nero

DKK - kr

1.095

1.195

1.195

cod.191.--/IGNNA
fire retardant, chromed frame
ignifuga, telaio cromato
Minimum order 300pcs/ Ordine minimo 300pz

1.395

AKAMI TB



Chromed or painted 4-Legged metal frame with armrests, techno-polymer shell.
Struttura in metallo 4 gambe con braccioli, cromata o verniciata, scocca in tecnopolimero.



only for painted frames
solo per telai verniciati

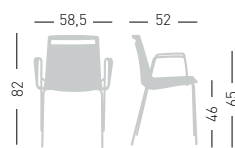

stackable / impilabile (4pcs)
NA not assembled / non assemblato



0,31 m³ - 12,2 kg.
61x55x93cm.
2 pcs [carton]

Frame Finishing & Codes / Finiture Telai e Codici

cod.191.--/TB chromed/cromata
cod.191.--/TBB white painted/verniciato bianco
cod.191.--/TBN black painted/verniciato nero

DKK - kr

1.595

1.695

1.695

Armrest white for shells cod. 00-42-52
Armrest black for shells cod. 06-10-14
Bracciolo bianco per scocche cod. 00-42-52
Bracciolo nero per scocche cod. 06-10-14

In case of painted frame, armrests color are combined with frame colors.
Nel caso di telai verniciati, il colore dei braccioli segue il colore dei telai.

AKAMI S



Chromed or painted wire steel sled frame, techno-polymer shell.
Struttura a slitta in filo, cromata o verniciata, scocca in tecnopolimero.



only for painted frames
solo per telai verniciati

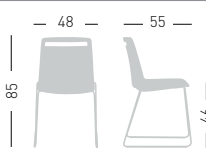

stackable / impilabile (8pcs)
NA not assembled / non assemblato



0,25 m³ - 23,40 kg.
67x56x64,5cm.
4 pcs [carton]

Frame Finishing & Codes / Finiture Telai e Codici

cod.191.--/S chromed/cromata
cod.191.--/SB white painted/verniciato bianco
cod.191.--/SN black painted/verniciato nero

DKK - kr

1.095

1.195

1.195

AKAMI SS



Chromed or white painted wire steel sled frame with armrests, techno-polymer shell.
Struttura a slitta in filo con braccioli, cromata o verniciata bianca, scocca in tecnopolimero.



only for painted frames
solo per telai verniciati

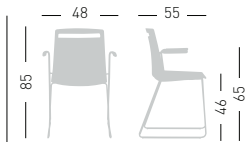

stackable / impilabile (8pcs)
NA not assembled / non assemblato



0,31 m³ - 13 kg.
61x55x93cm.
2 pcs [carton]

Frame Finishing & Codes / Finiture Telai e Codici

cod.191.--/SS chromed/cromata
cod.191.--/SSB white painted/verniciato bianco

DKK - kr

1.595
1.695

The arm pads are in the same color of the shell
Il copribrafcio è dello stesso colore della scocca

AKAMI BL



4-Legged wooden beech frame, techno-polymer shell.
Struttura in legno di faggio 4 gambe, scocca in tecnopolimero.

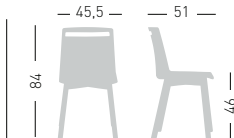

NA not assembled / non assemblato

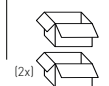

0,32 m³ - 27 kg.
60x56x51cm.

75x55x17cm.
4 pcs [carton]

Frame Finishing & Codes / Finiture Telai e Codici

cod.191.--/BLF

DKK - kr

2.395

Felt Glides / Tappi in feltro

AKAMI T5R



Swivel on 5-blade polished aluminum base with castors, height adjustable, techno-polymer shell.
Girevole su basamento 5 razze in alluminio pulito con ruote, regolabile in altezza, scocca in tecnopolimero.

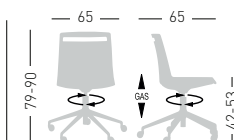

NA not assembled / non assemblato



0,25 m³ - 17,20 kg.
67x56x64,5cm.
2 pcs [carton]

Frame Finishing & Codes / Finiture Telai e Codici

cod.191._/T5R polished/pulita

DKK - kr

2.295

AKAMI T5R BRACCIOLO



Swivel on 5-blade polished aluminum base with castors, height adjustable, techno-polymer shell, armrests.
Girevole su basamento 5 razze in alluminio pulito con ruote, regolabile in altezza, scocca in tecnopolimero, braccioli.

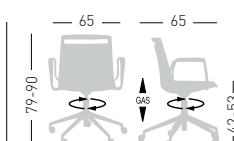

NA not assembled / non assemblato



0,25 m³ - 10,30 kg.
67x56x64,5cm.
1 pcs [carton]

Frame Finishing & Codes / Finiture Telai e Codici

cod.191._/T5RB polished/pulita

DKK - kr

2.895

Armrest white for shells cod. 00-35-52
Armrest black for shells cod. 06-10-14
Bracciolo bianco per scocche cod. 00-35-52
Bracciolo nero per scocche cod. 06-10-14

AKAMI U



Techno-polymer shell, swivel on 4-blade aluminum painted base.
Scocca in tecnopolimero, girevole su basamento verniciato in alluminio a 4 razze.

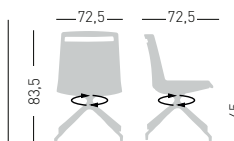

NA not assembled / non assemblato



0,54 m³ - 37 kg.
60x56x51cm.



60x56x51cm.
4 pcs [carton]

Frame Finishing & Codes / Finiture Telai e Codici

cod.191.--/UB white/bianca
cod.191.--/UN black/nera

DKK - kr

2.295
2.295

Felt Glides / Tappi in feltro

AKAMI UR



Techno-polymer shell, swivel on 4-blade aluminum painted base, with castors.
Scocca in tecnopolimero, girevole su basamento verniciato in alluminio a 4 razze, su ruote.

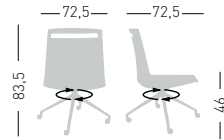

NA not assembled / non assemblato

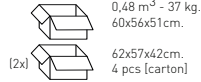

Frame Finishing & Codes / Finiture Telai e Codici

cod.191.--/URB white/bianca
cod.191.--/URN black/nera

DKK - kr

2.295
2.295

AKAMI U BR



Techno-polymer shell, swivel on 4-blade aluminum painted base, armrests.
Scocca in tecnopolimero, girevole su basamento verniciato in alluminio a 4 razze, braccioli.

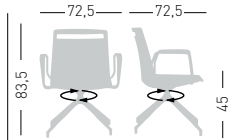

NA not assembled / non assemblato



Frame Finishing & Codes / Finiture Telai e Codici

cod.191.--/UBB white/bianca
cod.191.--/UNB black/nera

DKK - kr

2.495
2.495

Armrests and base colours are combined
I colori di braccioli e base sono combinati

Felt Glides / Tappi in feltro

AKAMI UR BR



Techno-polymer shell, swivel on 4-blade aluminum painted base, with castors and armrests.
Scocca in tecnopolimero, girevole su basamento verniciato in alluminio a 4 razze su ruote, braccioli.

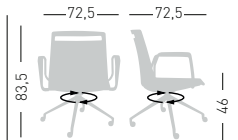

NA not assembled / non assemblato

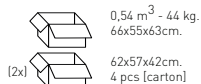

Frame Finishing & Codes / Finiture Telai e Codici

cod.191.--/URBB white/bianca
cod.191.--/URNB black/nera

DKK - kr

2.495
2.495

Armrests and base colours are combined
I colori di braccioli e base sono combinati

AKAMI PG



2-3-4-5 seat benches, metal-polymer co-injected legs, techno-polymer shell.
Panca a 2-3-4-5 posti, gambe co-iniettate in metallo-polimero, scocca in tecnopolimero.

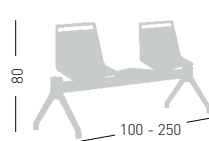

NA not assembled / non assemblato



0,28 m³ - 27 kg.
1 pcs [carton]

0,29 m³ - 33 kg.
1 pcs [carton]

0,30 m³ - 39 kg.
1 pcs [carton]

0,31 m³ - 44 kg.
1 pcs [carton]

Frame Finishing & Codes / Finiture Telai e Codici

cod.191.--/PG2P-- (100 cm)

cod.191.--/PG3P-- (150 cm)

cod.191.--/PG4P-- (200 cm)

cod.191.--/PG5P-- (250 cm)

DKK - kr

3.895

4.395

4.895

5.395

Bench legs available colors: 00-06-10-13-14-33-34-42
It is possible to change a seat with a grey metal top.

Outdoor version on request.

Colori disponibili gambe panca: 00-06-10-13-14-33-34-42

È possibile sostituire la seduta con un tavolino grigio in metallo. Versione per esterni su richiesta.

AKAMI CUSHION / CUSCINO



Cushion available in eco-leather aurea, King, Fenice and Kvadrat fabrics.
Cuscino in ecopelle aurea, tessuti King, Fenice e Kvadrat.



0,5 kg.
Inside chairs boxes
Nella scatola delle sedie.

Frame Finishing & Codes / Finiture Telai e Codici

cod.305.-- (B)

cod.305.-- (E)

cod.305.-- (K)

cod.305.-- (DK)

cod.305.TC COM fabric/tessuto cliente

DKK - kr

625

550

550

650

475

Available fabric.
Tessuti disponibili.

B, E, K, DK
COM fabric / Tessuto cliente **TC**

Minimum order 4pcs each code
Ordine minimo 4 pezzi per codice

COM fabric minimum order 10pcs each code
Tessuto cliente TC ordine minimo 10pz per codice

Fabric required / Fabbisogno di tessuto
4 pcs : Lin Mtrs 1 (h1,40)

AKAMI
CONNECTING SYSTEM
GANCIO CONNESSIONE

Extensible chromed linking devices for in-line disposal.
Agganci estensibili cromati per disporre le sedute in linea.



Inside chairs boxes
Nella scatola delle sedie.

Frame Finishing & Codes / Finiture Telai e Codici

cod.1004

DKK - kr

250

available for models: NA, TB, S, SS, SST
disponibile per versioni: NA, TB, S, SS, SST



AKAMI
CONNECTING SYSTEM
GANCIO CONNESSIONE

Set linking glides for in-line disposal.
Set piedini con agganci per disporre le sedute in linea.



Inside chairs boxes
Nella scatola delle sedie.

Frame Finishing & Codes / Finiture Telai e Codici

cod.1014

DKK - kr

125

available for models: S, SST
disponibile per versioni: S, SST



Assembled / assemblato

AKAMI
CHAIRS TROLLEY
CARRELLO PER SEDIE

Trolley for chairs, chromed metal structure.
Carrello porta sedie, struttura in metallo cromato.



Frame Finishing & Codes / Finiture Telai e Codici

cod.2000/A

DKK - kr

2.075

available for models: S-SS
disponibile per versioni: S-SS

stackable on trolley 18 pcs
impilabili su carrello 18 pcs

max height with 18 chairs 188 cm
altezza carrello con 18 sedie 188 cm



0,3 m³ - 10kg
63x75x58cm.
1 pcs [carton]



AKAMI
CHAIRS TROLLEY
CARRELLO PER SEDIE

Painted grey adjustable Dolly, for 4 legged chairs.
Carrello per sedie 4 gambe, regolabile, verniciato grigio.

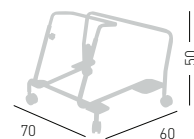

Frame Finishing & Codes / Finiture Telai e Codici

cod.2001/A

DKK - kr

2.275

available for models: NA
disponibile per versioni: NA



0,3 m³ - 8kg
62x72x51cm.
1 pcs [carton]



AKAMI UPHOLSTERED IMBOTTITE

Available coverings / Rivestimenti disponibili
Blazer fabric / Tessuto Blazer **B** (4pcs min.)
King fabric / Tessuto King **K** (4pcs min.)
Kvadrat fabrics / Tessuti Kvadrat **DK** (4pcs min.)
COM fabric / Tessuto cliente **TC** (10pcs min.)

Products follows UNI 9175 -UNI 9175/FA, in terms of Fire Resistance, Fire Reation Class 11M
Prodotto Omologato dal Ministero dell'Interno, secondo la UNI 9175 -UNI 9175/FA, con classe di Reazione al fuoco 11M



AKAMI NA UPHOLSTERED



PU-Flex padded and upholstered shell, chromed or painted 4 legged metal frame.
Scocca imbottita in PU-Flex e rivestita, telaio 4 gambe in metallo cromato o verniciato.

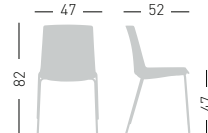

NA not assembled / non assemblato



0,25 m³ - 13 kg.
67x56x64,5cm.
2 pcs [carton]

Frame Finishing & Codes / Finiture Telai e Codici

cod.191.--/IKNA chromed/cromata
cod.191.--/IKNAB white painted/verniciato bianco
cod.191.--/IKNAN black painted/verniciato nero
cod.191.--/IBNA chromed/cromata
cod.191.--/IBNAB white painted/verniciato bianco
cod.191.--/IBNAN black painted/verniciato nero
cod.191.--/IDKNA chromed/cromata
cod.191.--/IDKNAB white painted/verniciato bianco
cod.191.--/IDKNAN black painted/verniciato nero
cod.191/ITCNA chromed/cromata
cod.191/ITCNAB white painted/verniciato bianco
cod.191/ITCNAN black painted/verniciato nero

DKK - kr

2.395
2.495
2.495
2.495
2.595
2.595
3.095
3.195
3.195
2.095
2.295
2.295

Fabric required
Fabbisogno di tessuto
1 pcs: Lin Mtrs 1,0 (h1,40)

COM fabric min. order
10pcs each code
Tessuto cliente TC ordine
min. 10pz per codice

Min. order 4pcs
each code
Ordine min 4pz
per codice

AKAMI TB UPHOLSTERED



PU-Flex padded and upholstered shell, chromed or painted 4 legged metal frame with armrests.
Scocca imbottita in PU-Flex e rivestita, telaio 4 gambe con braccioli in metallo cromato o verniciato.

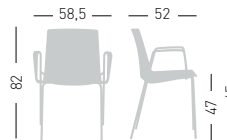

NA not assembled / non assemblato



0,31 m³ - 14 kg.
61x55x93cm.
2 pcs [carton]

Frame Finishing & Codes / Finiture Telai e Codici

cod.191.--/IKTB chromed/cromata
cod.191.--/IKTBB white painted/verniciato bianco
cod.191.--/IKTBN black painted/verniciato nero
cod.191.--/IBTB chromed/cromata
cod.191.--/IBTBB white painted/verniciato bianco
cod.191.--/IBTBN black painted/verniciato nero
cod.191.--/IDKTB chromed/cromata
cod.191.--/IDKTBB white painted/verniciato bianco
cod.191.--/IDKTN black painted/verniciato nero
cod.191/ITCTB chromed/cromata
cod.191/ITCTBB white painted/verniciato bianco
cod.191/ITCTBN black painted/verniciato nero

DKK - kr

2.695
2.895
2.895
2.895
2.995
2.995
3.395
3.595
3.595
2.495
2.595
2.595

Fabric required
Fabbisogno di tessuto
1 pcs: Lin Mtrs 1,0 (h1,40)

COM fabric min. order
10pcs each code
Tessuto cliente TC ordine
min. 10pz per codice

Min. order 4pcs
each code
Ordine min 4pz
per codice

Specify on the order the colour of the armrest: white or black
Specificare nell'ordine il colore del bracciolo: bianco o nero

AKAMI S UPHOLSTERED



PU-Flex padded and upholstered shell, chromed or painted wire steel sled frame.
Scocca imbottita in PU-Flex e rivestita, telaio slitta in filo metallo cromato o verniciato.

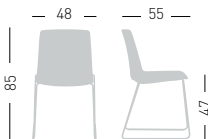

NA not assembled / non assemblato



0,25 m³ - 15 kg.
67x56x64,5cm.
2 pcs [carton]

Frame Finishing & Codes / Finiture Telai e Codici

cod.191.--/IKS chromed/cromata
cod.191.--/IKSB white painted/verniciato bianco
cod.191.--/IKSN black painted/verniciato nero
cod.191.--/IBS chromed/cromata
cod.191.--/IBSB white painted/verniciato bianco
cod.191.--/IBSN black painted/verniciato nero
cod.191.--/IDKS chromed/cromata
cod.191.--/IDKSB white painted/verniciato bianco
cod.191.--/IDKSN black painted/verniciato nero
cod.191/ITCS chromed/cromata
cod.191/ITCSB white painted/verniciato bianco
cod.191/ITCSN black painted/verniciato nero

DKK - kr

2.395
2.495
2.495
2.495
2.695
2.695
3.095
3.195
3.195
2.095
2.295
2.295

Fabric required
Fabbisogno di tessuto
1 pcs: Lin Mtrs 1,0 (h1,40)

COM fabric min. order
10pcs each code
Tessuto cliente TC ordine
min. 10pz per codice

Min. order 4pcs
each code
Ordine min 4pz
per codice

AKAMI SS UPHOLSTERED



PU-Flex padded and upholstered shell, chromed or painted wire steel sled frame with armrests.
Scocca imbottita in PU-Flex e rivestita, telaio in slitta in filo con braccioli cromato o verniciato.

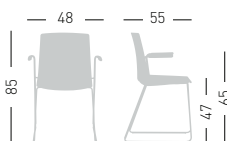

NA not assembled / non assemblato



0,31 m³ - 15 kg.
61x55x93cm.
2 pcs [carton]

Frame Finishing & Codes / Finiture Telai e Codici

cod.191.--/IKSS chromed/cromata
cod.191.--/IKSSB white painted/verniciato bianco
cod.191.--/IBSS chromed/cromata
cod.191.--/IBSSB white painted/verniciato bianco
cod.191.--/IDKSS chromed/cromata
cod.191.--/IDKSSB white painted/verniciato bianco
cod.191/ITCSS chromed/cromata
cod.191/ITCSSB white painted/verniciato bianco

DKK - kr

2.695
2.895
2.895
2.995
3.395
3.595
2.495
2.595

Fabric required
Fabbisogno di tessuto
1 pcs: Lin Mtrs 1,0 (h1,40)

COM fabric min. order
10pcs each code
Tessuto cliente TC ordine
min. 10pz per codice

Min. order 4pcs
each code
Ordine min 4pz
per codice

Specify on the order the colour of the armrest: white or black
Specificare nell'ordine il colore del bracciolo: bianco o nero

AKAMI BL
UPHOLSTERED



4-Legged wooden beech frame, PU-Flex padded and upholstered shell.
Struttura in legno di faggio 4 gambe, scocca imbottita in PU-Flex e rivestita.



F

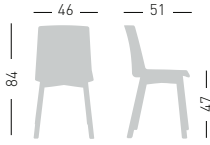

NA not assembled / non assemblato



Frame Finishing & Codes / Finiture Telai e Codici

cod.191.--/IKBLF
cod.191.--/IBBLF
cod.191.--/IDKBLF
cod.191.--/ITCBLF

DKK - kr

3.595
3.795
4.295
3.395

Felt Glides / Tappi in feltro

Fabric required
Fabbisogno di tessuto
1 pcs: Lin Mtrs 1,0 (h1,40)

COM fabric min. order
10pcs each code
Tessuto cliente TC ordine
min. 10pz per codice

Min. order 4pcs
each code
Ordine min 4pz
per codice

AKAMI T5R
UPHOLSTERED



PU-Flex padded and upholstered shell, swivel, height adjustable, polished aluminum base with castors.
Scocca imbottita in PU-Flex e rivestita, girevole, regolabile in altezza, base in alluminio pulito con ruote.

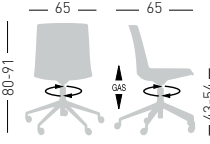

NA not assembled / non assemblato



Frame Finishing & Codes / Finiture Telai e Codici

cod.191._/IKT5R polished/pulita
cod.191._/IBT5R polished/pulita
cod.191._/IDKT5R polished/pulita
cod.191/ITCT5R polished/pulita

DKK - kr

3.195
3.395
3.895
2.995

Fabric required
Fabbisogno di tessuto
1 pcs: Lin Mtrs 1,0 (h1,40)

COM fabric min. order
10pcs each code
Tessuto cliente TC ordine
min. 10pz per codice

Min. order 4pcs
each code
Ordine min 4pz
per codice

AKAMI T5R
BRACCIOLO
UPHOLSTERED



PU-Flex padded and upholstered shell, swivel, height adjustable, polished aluminum base with castors.
Scocca imbottita in PU-Flex e rivestita, girevole, regolabile in altezza, base in alluminio pulito con ruote.

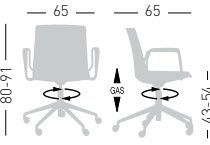

NA not assembled / non assemblato



Frame Finishing & Codes / Finiture Telai e Codici

cod.191._/IKT5RB polished/pulita
cod.191._/IBT5RB polished/pulita
cod.191._/IDKT5RB polished/pulita
cod.191/ITCT5RB polished/pulita

DKK - kr

3.395
3.595
4.095
3.195

Fabric required
Fabbisogno di tessuto
1 pcs: Lin Mtrs 1,0 (h1,40)

COM fabric min. order
10pcs each code
Tessuto cliente TC ordine
min. 10pz per codice

Min. order 4pcs
each code
Ordine min 4pz
per codice

Specify on the order the colour of the armrest: white or black
Specificare nell'ordine il colore del bracciolo: bianco o nero

AKAMI U
UPHOLSTERED



PU-Flex padded and upholstered shell, swivel on 4-blade aluminum painted base.
Scocca imbottita in PU-Flex e rivestita, girevole su basamento verniciato in alluminio a 4 razze.

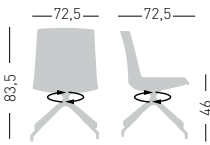

NA not assembled / non assemblato

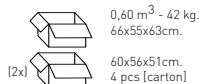

Frame Finishing & Codes / Finiture Telai e Codici

cod.191.--/IKUB white/bianca
cod.191.--/IKUN black/nera
cod.191.--/IKUL polished/lucida
cod.191.--/IBUB white/bianca
cod.191.--/IBUN black/nera
cod.191.--/IBUL polished/lucida
cod.191.--/IDKU white/bianca
cod.191.--/IDKUN black/nera
cod.191.--/IDKUL polished/lucida
cod.191/ITCUB white/bianca
cod.191/ITCUN black/nera
cod.191/ITCUN polished/lucida

DKK - kr

3.495
3.495
3.595
3.595
3.595
3.795
4.195
4.195
4.295
3.195
3.195
3.395

Felt Glides / Tappi in feltro
Fabric required
Fabbisogno di tessuto
1 pcs: Lin Mtrs 1,0 (h1,40)

COM fabric min. order
10pcs each code
Tessuto cliente TC ordine
min. 10pz per codice

Min. order 4pcs
each code
Ordine min 4pz
per codice

AKAMI UR
UPHOLSTERED



PU-Flex padded and upholstered shell, swivel on 4-blade aluminum painted base, with castors.
Scocca imbottita in PU-Flex e rivestita, girevole su basamento verniciato in alluminio a 4 razze, su ruote.

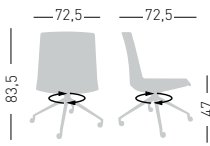

NA not assembled / non assemblato

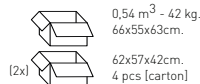

Frame Finishing & Codes / Finiture Telai e Codici

cod.191.--/IKURB white/bianca
cod.191.--/IKURN black/nera
cod.191.--/IKURL polished/lucida
cod.191.--/IBURB white/bianca
cod.191.--/IBURN black/nera
cod.191.--/IBURL polished/lucida
cod.191.--/IDKURB white/bianca
cod.191.--/IDKURN black/nera
cod.191.--/IDKURL polished/lucida
cod.191/ITCURB white/bianca
cod.191/ITCURN black/nera
cod.191/ITCURL polished/lucida

DKK - kr

3.695
3.695
3.795
3.795
3.795
3.995
4.395
4.395
4.495
3.395
3.395
3.395
3.595

Fabric required
Fabbisogno di tessuto
1 pcs: Lin Mtrs 1,0 (h1,40)

COM fabric min. order
10pcs each code
Tessuto cliente TC ordine
min. 10pz per codice

Min. order 4pcs
each code
Ordine min 4pz
per codice

AKAMI U BR UPHOLSTERED



PU-Flex padded and upholstered shell, swivel on 4-blade aluminum painted base, armrests.
Scocca imbottita in PU-Flex e rivestita, girevole su basamento verniciato in alluminio a 4 razze, braccioli.

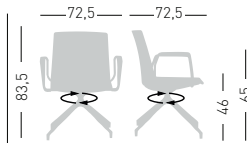

NA not assembled / non assemblato

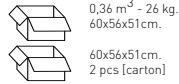

Specify in the order the color of the armrest: white or black
Specificare nell'ordine il colore del bracciolo: bianco o nero

Frame Finishing & Codes / Finiture Telai e Codici

cod.191. __ /IKUBB white/bianca
cod.191. __ /IKUNB black/nera
cod.191. __ /IKULB polished/lucida
cod.191. __ /IBUBB white/bianca
cod.191. __ /IBUNB black/nera
cod.191. __ /IBULB polished/lucida
cod.191. __ /IDKUBB white/bianca
cod.191. __ /IDKUNB black/nera
cod.191. __ /IDKULB polished/lucida
cod.191. -- /ITCUBB white/bianca
cod.191. -- /ITCUNB black/nera
cod.191. -- /ITCULB polished/lucida
Felt Glides / Tappi in feltro

DKK - kr

3.795
3.795
3.895
3.895
3.895
4.095
4.495
4.495
4.595
3.495
3.495
3.695

Fabric required
Fabbisogno di tessuto
1 pcs: Lin Mtrs 1,0 (h1,40)

COM fabric min. order
10pcs each code
Tessuto cliente TC ordine
min. 10pz per codice

Min. order 4pcs
each code
Ordine min 4pz
per codice

AKAMI UR BR UPHOLSTERED



PU-Flex padded and upholstered shell, swivel on 4-blade aluminum painted base, with castors and armrests.
Scocca imbottita in PU-Flex e rivestita, girevole su basamento verniciato in alluminio a 4 razze su ruote, braccioli.

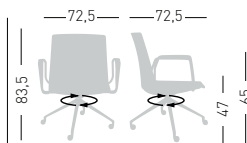

NA not assembled / non assemblato

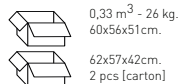

Specify in the order the color of the armrest: white or black
Specificare nell'ordine il colore del bracciolo: bianco o nero

Frame Finishing & Codes / Finiture Telai e Codici

cod.191. __ /IKURBB white/bianca
cod.191. __ /IKURNB black/nera
cod.191. __ /IKURLB polished/lucida
cod.191. __ /IBURBB white/bianca
cod.191. __ /IBURNB black/nera
cod.191. __ /IBURLB polished/lucida
cod.191. __ /IDKURBB white/bianca
cod.191. __ /IDKURNB black/nera
cod.191. __ /IDKURLB polished/lucida
cod.191. -- /ITCURBB white/bianca
cod.191. -- /ITCURNB black/nera
cod.191. -- /ITCURLB polished/lucida

DKK - kr

3.995
3.995
4.095
4.095
4.095
4.295
4.695
4.695
4.795
3.795
3.795
3.895

Fabric required
Fabbisogno di tessuto
1 pcs: Lin Mtrs 1,0 (h1,40)

COM fabric min. order
10pcs each code
Tessuto cliente TC ordine
min. 10pz per codice

Min. order 4pcs
each code
Ordine min 4pz
per codice

AKAMI PG UPHOLSTERED



PU-FLEX shell upholstered by King, Kvadrat or Fenice fabric.
Scocca in PU-FLEX rivestito tessuto King, Kvadrat o Fenice.



NA not assembled / non assemblato

Fabric required
Fabbisogno di tessuto
1 pcs: Lin Mtrs 1,0 (h1,40)



0,28 m³ - 29 kg.
55x66,5x63cm.
1 pcs [carton]

0,29 m³ - 35 kg.
55x66,5x63cm.
1 pcs [carton]

0,30 m³ - 41 kg.
55x66,5x63cm.
1 pcs [carton]

0,31 m³ - 47 kg.
55x66,5x63cm.
1 pcs [carton]

Frame Finishing & Codes / Finiture Telai e Codici

cod.191. -- /IKPG2P-- (100 cm)
cod.191. -- /IKPG3P-- (150 cm)
cod.191. -- /IKPG4P-- (200 cm)
cod.191. -- /IKPG5P-- (250 cm)
cod.191. -- /IDKPG2P-- (100 cm)
cod.191. -- /IDKPG3P-- (150 cm)
cod.191. -- /IDKPG4P-- (200 cm)
cod.191. -- /IDKPG5P-- (250 cm)
cod.191. -- /IBPG2P-- (100 cm)
cod.191. -- /IBPG3P-- (150 cm)
cod.191. -- /IBPG4P-- (200 cm)
cod.191. -- /IBPG5P-- (250 cm)
cod.191./ITCPG2P-- (100 cm)
cod.191./ITCPG3P-- (150 cm)
cod.191./ITCPG4P-- (200 cm)
cod.191./ITCPG5P-- (250 cm)

DKK - kr

6.195
7.695
9.295
10.895
7.595
9.795
12.095
14.395
6.295
7.895
9.395
10.995
5.595
6.995
8.295
9.595

Bench legs available colors: 00-06-10-13-14-33-34-42
It is possible to change a seat with a grey metal top.
Colori disponibili gambe panca: 00-06-10-13-14-33-34-42
È possibile sostituire la seduta con un tavolino grigio in metallo.

Alhambra



Available colors / Colori disponibili

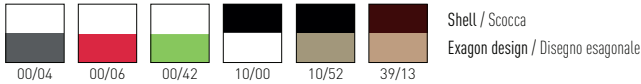

ALHAMBRA NA



Chromed, black or white painted
4-Legged metal frame, techno-
polymer multicolor shell.
Struttura in metallo 4 gambe, cromata,
verniciata nera o bianca, scocca in
tecnopolimero multicolore.



only for painted frames
solo per telai verniciati

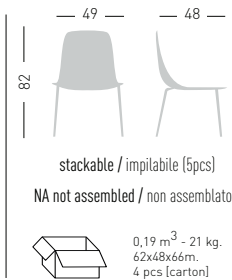

Frame Finishing & Codes / Finiture Telai e Codici

cod.92.--/NA chromed/cromata
cod.92.--/NAB white painted/verniciato bianco
cod.92.--/NAN black painted/verniciato nero

DKK - kr

895
1.095
1.095

ALHAMBRA TB



Chromed or painted 4-Legged metal
frame with armrests, techno-polymer
multicolor shell.
Struttura in metallo 4 gambe con
braccioli, cromata o verniciata, scocca
in tecnopolimero multicolore



only for painted frames
solo per telai verniciati

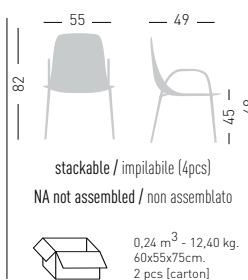

Frame Finishing & Codes / Finiture Telai e Codici

cod.92.--/TB chromed/cromata
cod.92.--/TBB white painted/verniciato bianco

DKK - kr

1.295
1.495

ALHAMBRA TC



Chromed or painted wire steel
metal frame, techno-polymer
multicolor shell.
Struttura a traliccio in filo, cromata
o verniciata, scocca in tecnopolimero
multicolore.



only for painted frames
solo per telai verniciati

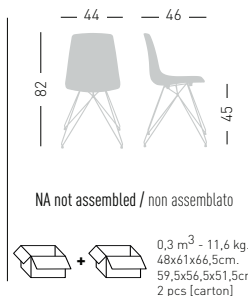

Frame Finishing & Codes / Finiture Telai e Codici

cod.92.--/TC chromed/cromata
cod.92.--/TCB white painted/verniciato bianco
cod.92.--/TCN black painted/verniciato nero

DKK - kr

1.395
1.495
1.495

ALHAMBRA TP



Techno-polymer 4-Legged frame, white painted, techno-polymer multicolor shell.
Struttura in tecnopolimero 4 gambe verniciata bianca, scocca in tecnopolimero multicolore.

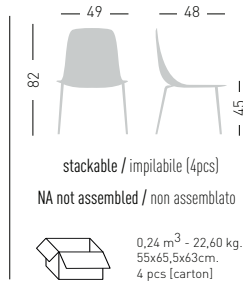

Frame Finishing & Codes / Finiture Telai e Codici

cod.92.--/TPB white/bianco

DKK - kr

1.195

ALHAMBRA S



Chromed, black or white painted wire steel sled frame, techno-polymer multicolor shell.
Struttura a slitta in filo, cromata o verniciata nera o bianca, scocca in tecnopolimero multicolore.



only for paintend frames
solo per telai verniciati

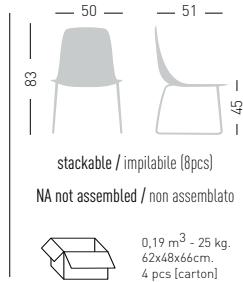

Frame Finishing & Codes / Finiture Telai e Codici

cod.92.--/S chromed/cromata
cod.92.--/SB white painted/verniciato bianco
cod.92.--/SN black painted/verniciato nero

DKK - kr

895
1.095
1.095

ALHAMBRA ST



Chromed or painted sled steel frame, techno-polymer multicolor shell.
Struttura a slitta, cromata o verniciata, scocca in tecnopolimero multicolore.



only for paintend frames
solo per telai verniciati

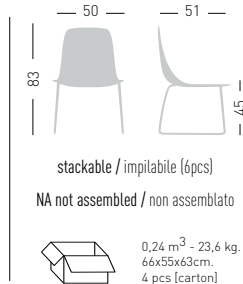

Frame Finishing & Codes / Finiture Telai e Codici

cod.92.--/ST chromed/cromata
cod.92.--/STB white painted/verniciato bianco
cod.92.--/STN black painted/verniciato nero

DKK - kr

1.095
1.195
1.195

ALHAMBRA 5R



Swivel on polished aluminum base with castors, height adjustable, techno-polymer multicolor shell.
Girevole su basamento in alluminio pulito con ruote, regolabile in altezza, scocca in tecnopolimero multicolore.

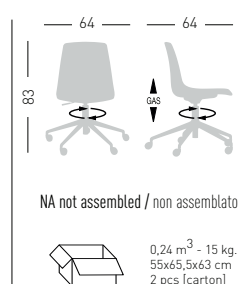

Frame Finishing & Codes / Finiture Telai e Codici

cod.92.--/5R polished/lucida

DKK - kr

2.095

ALHAMBRA L



Swivel on 4-spur polished aluminum base, techno-polymer multicolor shell.
Girevole su basamento 4 razze in alluminio pulito, scocca in tecnopolimero multicolore.

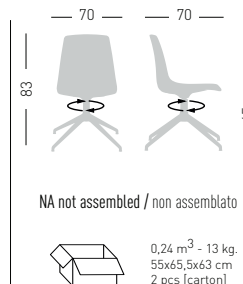

Frame Finishing & Codes / Finiture Telai e Codici

cod.92.--/L polished/lucida

DKK - kr

2.095

Felt Glides / Tappi in feltro

ALHAMBRA ECO



"Compound wood" and techno-polymer 4-Legged frame and shell. Scocca e struttura a 4 gambe in composito di legno e materiale plastico.



ECO/13

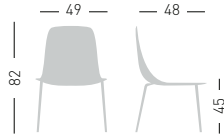

stackable / impilabile (4pcs)
NA not assembled / non assemblato



0,24 m³ - 22 kg.
55x65,5x63cm.
4 pcs [carton]

Frame Finishing & Codes / Finiture Telai e Codici

cod.92.ECO-13/TPE

DKK - kr

1.495

ALHAMBRA CONNECTING SYSTEM GANCIO CONNESSIONE



Set linking glides for in-line disposal. Set piedini con agganci per disporre le sedute in linea.



Inside chairs boxes
Nella scatola delle sedie.

Assembled / assemblato

Frame Finishing & Codes / Finiture Telai e Codici

cod.1012

DKK - kr

125

available for models: S
disponibile per versioni: S

ALHAMBRA CHAIRS TROLLEY CARRELLO PER SEDIE



Trolley for chairs, chromed metal structure. Carrello porta sedie, struttura in metallo cromato.

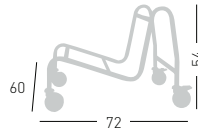

0,3 m³ - 10kg
63x75x58cm.
1 pcs [carton]

Frame Finishing & Codes / Finiture Telai e Codici

cod.2000/A

DKK - kr

2.075

available for models: S
disponibile per versioni: S

stackable on trolley 18 pcs
impilabili su carrello 18 pcs

max height with 18 chairs 178 cm
altezza carrello con 18 sedie 178 cm

ALHAMBRA CHAIRS TROLLEY CARRELLO PER SEDIE



Painted grey adjustable Dolly, for 4 legged chairs. Carrello per sedie 4 gambe, regolabile, verniciato grigio.

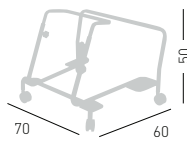

0,3 m³ - 8kg
62x72x51cm.
1 pcs [carton]

Frame Finishing & Codes / Finiture Telai e Codici

cod.2001/A

DKK - kr

2.275

available for models: NA
disponibile per versioni: NA

ALHAMBRA UPHOLSTERED IMBOTTITE

Available fabric / Tessuti disponibili
Aurea eco-leather / Ecopelle aurea **E** (4pcs min.)
King fabric / Tessuto King **K** (4pcs min.)
Blazer fabric / Tessuto Blazer **B** (4pcs min.)
COM fabric / Tessuto cliente **TC** (10pcs min.)

DRESS ALHAMBRA BL



Techno-polymer padded and upholstered shell. Beech wooden frame
Scocca in tecnopolimero, imbottita e rivestita. Telaio in legno.

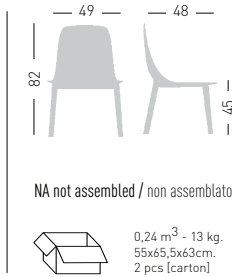

Frame Finishing & Codes / Finiture Telai e Codici

cod.92.--/IEBLF beech/faggio
cod.92.--/IKBLF beech/faggio
cod.92.--/IBBLF beech/faggio
cod.92.--/ITCBLF beech/faggio

DKK - kr

3.795
3.795
3.895
3.495

Felt Glides / Tappi in feltro

Fabric required
Fabbisogno di tessuto
1 pcs: Lin Mtrs 1,0 (h1,40)

COM fabric min. order
10pcs each code
Tessuto cliente TC ordine
min. 10pz per codice

Min. order 4pcs
each code
Ordine min 4pz
per codice

DRESS ALHAMBRA NA



Techno-polymer padded and upholstered shell. Chromed, black or white painted metal frame.
Scocca in tecnopolimero, imbottita e rivestita. Telaio in metallo cromato, verniciato nero o bianco.

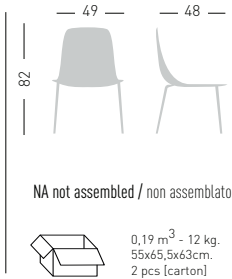

Frame Finishing & Codes / Finiture Telai e Codici

cod.92.--/IENA chromed/cromata
cod.92.--/IKNA chromed/cromata
cod.92.--/IBNA chromed/cromata
cod.92./ITCNA chromed/cromata
cod.92.--/IENAB white painted/verniciato bianco
cod.92.--/IKNAB white painted/verniciato bianco
cod.92.--/IBNAB white painted/verniciato bianco
cod.92./ITCNAB white painted/verniciato bianco
cod.92.--/IENAN black painted/verniciato nero
cod.92.--/IKNAN black painted/verniciato nero
cod.92.--/IBNAN black painted/verniciato nero
cod.92./ITCNAN black painted/verniciato nero

DKK - kr

2.095
2.095
2.295
1.895
2.295
2.295
2.395
1.995
2.295
2.295
2.395
1.995

Fabric required
Fabbisogno di tessuto
1 pcs: Lin Mtrs 1,0 (h1,40)

COM fabric min. order
10pcs each code
Tessuto cliente TC ordine
min. 10pz per codice

Min. order 4pcs
each code
Ordine min 4pz
per codice

DRESS ALHAMBRA TB



Techno-polymer padded and upholstered shell. Chromed or painted metal frame with arms.
Scocca in tecnopolimero, imbottita e rivestita. Telaio in metallo cromato o verniciato con braccioli.

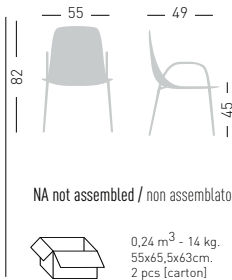

Frame Finishing & Codes / Finiture Telai e Codici

cod.92.--/IETB chromed/cromata
cod.92.--/IKTB chromed/cromata
cod.92.--/IBTB chromed/cromata
cod.92./ITCTB chromed/cromata
cod.92.--/IETBB white painted/verniciato bianco
cod.92.--/IKTBB white painted/verniciato bianco
cod.92.--/IBTBB white painted/verniciato bianco
cod.92./ITCTBB white painted/verniciato bianco

DKK - kr

2.295
2.295
2.495
2.095
2.595
2.595
2.795
2.395

Fabric required
Fabbisogno di tessuto
1 pcs: Lin Mtrs 1,0 (h1,40)

COM fabric min. order
10pcs each code
Tessuto cliente TC ordine
min. 10pz per codice

Min. order 4pcs
each code
Ordine min 4pz
per codice

DRESS ALHAMBRA TC



Techno-polymer padded and upholstered shell. Chromed or painted metal frame.
Scocca in tecnopolimero, imbottita e rivestita. Telaio in metallo cromato o verniciato.

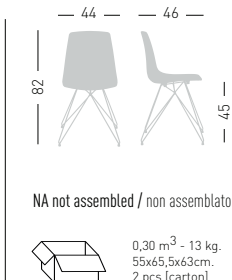

Frame Finishing & Codes / Finiture Telai e Codici

cod.92.--/IETC chromed/cromata
cod.92.--/IKTC chromed/cromata
cod.92.--/IBTC chromed/cromata
cod.92./ITCTC chromed/cromata
cod.92.--/IETCB white painted/verniciato bianco
cod.92.--/IKTCB white painted/verniciato bianco
cod.92.--/IBTCB white painted/verniciato bianco
cod.92./ITCTCB white painted/verniciato bianco
cod.92.--/IETCN black painted/verniciato nero
cod.92.--/IKTCN black painted/verniciato nero
cod.92.--/IBTCN black painted/verniciato nero
cod.92./ITCTCN black painted/verniciato nero

DKK - kr

2.495
2.495
2.595
2.195
2.595
2.595
2.795
2.395
2.595
2.595
2.795
2.395

Fabric required
Fabbisogno di tessuto
1 pcs: Lin Mtrs 1,0 (h1,40)

COM fabric min. order
10pcs each code
Tessuto cliente TC ordine
min. 10pz per codice

Min. order 4pcs
each code
Ordine min 4pz
per codice

DRESS ALHAMBRA TP



Techno-polymer padded and upholstered shell. Techno-polymer painted frame.
Scocca in tecnopolimero, imbottita e rivestita. Telaio in tecnopolimero verniciato.

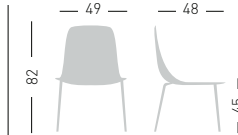

NA not assembled / non assemblato



0,24 m³ - 13 kg.
55x65,5x63cm.
2 pcs [carton]

Frame Finishing & Codes / Finiture Telai e Codici

cod.92.--/IETPB white painted/verniciato bianco
cod.92.--/IKTPB white painted/verniciato bianco
cod.92.--/IBTPB white painted/verniciato bianco
cod.92./ITCTPB white painted/verniciato bianco

DKK - kr

2.495
2.495
2.595
2.195

Fabric required
Fabbisogno di tessuto
1 pcs: Lin Mtrs 1,0 (h1,40)

COM fabric min. order
10pcs each code
Tessuto cliente TC ordine
min. 10pz per codice

Min. order 4pcs
each code
Ordine min 4pz
per codice

DRESS ALHAMBRA S



Techno-polymer padded and upholstered shell. Chromed, painted black or white wire steel metal frame.
Scocca in tecnopolimero, imbottita e rivestita. Telaio slitta in filo cromato, verniciato nero o bianco.

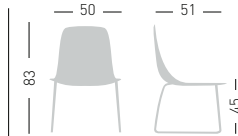

NA not assembled / non assemblato



0,24 m³ - 14 kg.
55x65,5x63cm.
2 pcs [carton]

Frame Finishing & Codes / Finiture Telai e Codici

cod.92.--/IES chromed/cromata
cod.92.--/IKS chromed/cromata
cod.92.--/IBS chromed/cromata
cod.92./ITCS chromed/cromata
cod.92.--/IESB white painted/verniciato bianco
cod.92.--/IKSB white painted/verniciato bianco
cod.92.--/IBSB white painted/verniciato bianco
cod.92./ITCSB white painted/verniciato bianco
cod.92.--/IESN black painted/verniciato nero
cod.92.--/IKSN black painted/verniciato nero
cod.92.--/IBSN black painted/verniciato nero
cod.92./ITCSN black painted/verniciato nero

DKK - kr

2.195
2.195
2.295
1.995
2.395
2.395
2.495
2.095
2.395
2.395
2.495
2.095

Fabric required
Fabbisogno di tessuto
1 pcs: Lin Mtrs 1,0 (h1,40)

COM fabric min. order
10pcs each code
Tessuto cliente TC ordine
min. 10pz per codice

Min. order 4pcs
each code
Ordine min 4pz
per codice

DRESS ALHAMBRA ST



Techno-polymer padded and upholstered shell. Chromed or painted sled metal frame.
Scocca in tecnopolimero, imbottita e rivestita. Telaio slitta in metallo cromato o verniciato.

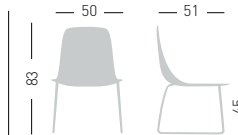

NA not assembled / non assemblato



0,24 m³ - 14 kg.
55x65,5x63cm.
2 pcs [carton]

Frame Finishing & Codes / Finiture Telai e Codici

cod.92.--/IEST chromed/cromata
cod.92.--/IKST chromed/cromata
cod.92.--/IBST chromed/cromata
cod.92./ITCST chromed/cromata
cod.92.--/IESTB white painted/verniciato bianco
cod.92.--/IKSTB white painted/verniciato bianco
cod.92.--/IBSTB white painted/verniciato bianco
cod.92./ITCSTB white painted/verniciato bianco
cod.92.--/IESTN black painted/verniciato nero
cod.92.--/IKSTN black painted/verniciato nero
cod.92.--/IBSTN black painted/verniciato nero
cod.92./ITCSTN black painted/verniciato nero

DKK - kr

2.395
2.395
2.495
2.095
2.595
2.595
2.695
2.295
2.595
2.595
2.695
2.295

Fabric required
Fabbisogno di tessuto
1 pcs: Lin Mtrs 1,0 (h1,40)

COM fabric min. order
10pcs each code
Tessuto cliente TC ordine
min. 10pz per codice

Min. order 4pcs
each code
Ordine min 4pz
per codice

DRESS ALHAMBRA 5R



Techno-polymer padded and upholstered shell. Polished aluminum base with castors.
Scocca in tecnopolimero, imbottita e rivestita. Base in alluminio pulito con ruote.

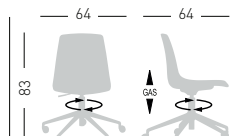

NA not assembled / non assemblato



0,24 m³ - 16 kg.
55x65,5x63 cm
2 pcs [carton]

Frame Finishing & Codes / Finiture Telai e Codici

cod.92.--/IE5R polished/lucida
cod.92.--/IK5R polished/lucida
cod.92.--/IB5R polished/lucida
cod.92./ITC5R polished/lucida

DKK - kr

3.195
3.195
3.295
2.895

Fabric required
Fabbisogno di tessuto
1 pcs: Lin Mtrs 1,0 (h1,40)

COM fabric min. order
10pcs each code
Tessuto cliente TC ordine
min. 10pz per codice

Min. order 4pcs
each code
Ordine min 4pz
per codice

DRESS ALHAMBRA LIE



Techno-polymer padded and upholstered shell. Polished aluminum base.
Scocca in tecnopolimero, imbottita e rivestita. Base in alluminio pulito.

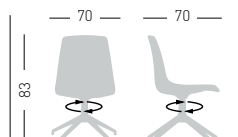

NA not assembled / non assemblato



0,24 m³ - 14 kg.
55x65,5x63 cm
2 pcs [carton]

Frame Finishing & Codes / Finiture Telai e Codici

cod.92.--/IEL polished/lucida
cod.92.--/IKL polished/lucida
cod.92.--/IBL polished/lucida
cod.92./ITCL polished/lucida

DKK - kr

3.195
3.195
3.295
2.895

Felt Glides / Tappi in feltro

Fabric required
Fabbisogno di tessuto
1 pcs: Lin Mtrs 1,0 (h1,40)

COM fabric min. order
10pcs each code
Tessuto cliente TC ordine
min. 10pz per codice

Min. order 4pcs
each code
Ordine min 4pz
per codice

Amitha



Available colors / Colori disponibili

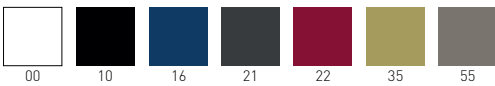

AMITHA



4-Legged metal chair, painted with special treatment for outdoor purpose.
Sedia con struttura 4 gambe in metallo verniciato con trattamento per esterno.



stackable / impilabile (4pcs)
A assembled / assemblato



0,38 m³ - 15,2 kg.
59x65x99cm.
2 pcs [carton]

Frame Finishing & Codes / Finiture Telai e Codici

cod. 77.__/A

DKK - kr

1.795

Min. order 4pcs
each code
Ordine min 4pz
per codice

AMITHA B



4-Legged metal chair with armrests, painted with special treatment for outdoor purpose.
Sedia con struttura 4 gambe con braccioli in metallo verniciato con trattamento per esterno.

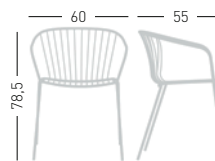

stackable / impilabile (4pcs)
A assembled / assemblato



0,38 m³ - 15,8 kg.
59x65x99cm.
2 pcs [carton]

Frame Finishing & Codes / Finiture Telai e Codici

cod. 78.__/A

DKK - kr

2.095

Min. order 4pcs
each code
Ordine min 4pz
per codice

AMITHA SLIM
CUSHION / CUSCINO



Cushion for Amitha chairs and armchairs, with removable cover, suitable for outdoor purpose; high density bi-elastic rubber padding, stitching made with raised edge. The cushion is fixed to the chair by Velcro straps.

Cuscino sfoderabile per sedie e sedie con braccioli Amitha, adatto ad uso per esterni; imbottiture in gomma bielastica ad alta densità, cucitura realizzata con bordino in rilievo riportato. Il cuscino si fissa alla sedia per mezzo di fascette in Velcro.



0,6 kg.
Inside chairs boxes
Inseriti nella
scatola delle sedie

Available fabric.
Tessuti disponibili.
MG, SX

Frame Finishing & Codes / Finiture Telai e Codici

cod. 338.-- (MG)
cod. 338.-- (SX)

DKK - kr

750
750

Min. order 4pcs
each code
Ordine min 4pz
per codice

AMITHA FAT
CUSHION / CUSCINO



Cushion for Amitha chairs and armchairs, suitable for outdoor purpose; wash up to 30°. The cushion is fixed to the chair by clip buttons.

Cuscino per sedie e poltroncine Amitha, adatto ad uso per esterni; lavabile a 30°. Il cuscino si fissa alla sedia per mezzo di bottoni a clip.



0,3 kg.
Inside chairs boxes
Inseriti nella
scatola delle sedie

Available fabric.
Tessuti disponibili.
GR

Frame Finishing & Codes / Finiture Telai e Codici

cod.435.-- (GR)

DKK - kr

750

Min. order 4pcs
each code
Ordine min 4pz
per codice

AMITHA FAT
SEAT & BACK
CUSHION / CUSCINO
SEDILE SCHIENALE



Seat-back cushion for Amitha chairs and armchairs, suitable for outdoor purpose; wash up to 30°. The cushion is fixed to the chair by clip buttons.

Cuscino sedile-schienale per sedie e poltroncine Amitha, adatto ad uso per esterni; lavabile a 30°. Il cuscino si fissa alla sedia per mezzo di bottoni a clip.



0,7 kg.
Inside chairs boxes
Inseriti nella
scatola delle sedie

Available fabric.
Tessuti disponibili.
GR

Frame Finishing & Codes / Finiture Telai e Codici

cod.434.-- (GR)

DKK - kr

1.600

Min. order 4pcs
each code
Ordine min 4pz
per codice



Amitha Lounge

Available colors / Colori disponibili

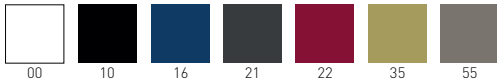

AMITHA LOUNGE

4-Legged metal lounge armchair, painted with special treatment for outdoor purpose.
Poltrona lounge con struttura 4 gambe in metallo verniciato con trattamento per esterno.

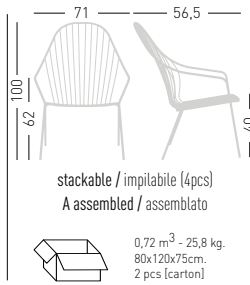

Frame Finishing & Codes / Finiture Telai e Codici

cod. 79.--/A

DKK - kr

5.395

AMITHA ROCKING LOUNGE

Rocking chair in a rodged metal frame on natural oak rockers.
Sedia a dondolo con struttura aerea in metallo e pattini in legno di rovere naturale.

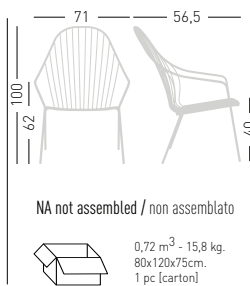

Frame Finishing & Codes / Finiture Telai e Codici

cod. 79.--/DRN

DKK - kr

8.795

AMITHA LOUNGE FAT SEAT & BACK CUSHION / CUSCINO SEDILE-SCHIENALE

Seat-back cushion for Amitha Lounge, suitable for outdoor purpose; wash up to 30°. The cushion is fixed to the chair by clip buttons.
Cuscino sedile-schienale per Amitha Lounge, adatto ad uso per esterni; lavabile a 30°. Il cuscino si fissa alla sedia per mezzo di bottoni a clip.



30°



1,1 kg.
Inside chairs boxes
Inseriti nella
scatola delle sedie

Frame Finishing & Codes / Finiture Telai e Codici

cod.433.-- (GR)

DKK - kr

2.075

Available fabric.
Tessuti disponibili.
GR

AMITHA POUF



Footrest pouf with painted metal structure with outdoor treatment. Pouf poggiatesta con struttura in metallo verniciato con trattamento per esterno.

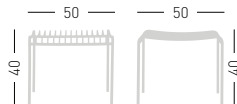

stackable / impilabile
A assembled / assemblato



0,17 m³ - 7,2 kg.
60x56x51cm.
1 pc [carton]

Frame Finishing & Codes / Finiture Telai e Codici

cod. 87.--/A

DKK - kr

2.095

AMITHA POUF FAT CUSHION / CUSCINO



30°

Cushion for Amitha Pouf, suitable for outdoor purpose; wash up to 30°. The cushion is fixed to the chair by clip buttons.

Cuscino per Pouf Amitha, adatto ad uso per esterni; lavabile a 30°. Il cuscino si fissa alla sedia per mezzo di bottoni a clip.



0,3 kg.
Inside chairs boxes
Inseriti nella
scatola delle sedie

Frame Finishing & Codes / Finiture Telai e Codici

cod. 431.-- (GR)

DKK - kr

750

Available fabric.
Tessuti disponibili.
GR

AMITHA BENCH



2-seater metal bench, painted with special treatment for outdoor purpose.

Panca 2 posti con struttura in metallo verniciato con trattamento per esterno.

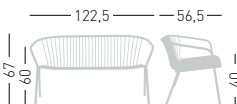

stackable / impilabile (4pcs)
A assembled / assemblato



0,66 m³ - 20,7 kg.
125x75x70cm.
1 pc [carton]

Frame Finishing & Codes / Finiture Telai e Codici

cod. 81.--/A

DKK - kr

9.195

AMITHA BENCH FAT SEAT & BACK CUSHION / CUSCINO SEDILE SCHIENALE



30°

Seat-back cushion for Amitha benches, suitable for outdoor purpose; wash up to 30°. The cushion is fixed to the chair by clip buttons.

Cuscino sedile-schienale per panche Amitha, adatto ad uso per esterni; lavabile a 30°. Il cuscino si fissa alla sedia per mezzo di bottoni a clip.



1,3 kg.
Inside chairs boxes
Inseriti nella
scatola delle sedie

Frame Finishing & Codes / Finiture Telai e Codici

cod. 432.-- (GR)

DKK - kr

2.500

Available fabric.
Tessuti disponibili.
GR

Artesia



IGN Versions follows UNI 9177 certification in terms of Fire Resistance, Fire Reaction Class 1
Versioni IGN prodotto Omologato con Classe di Reazione al fuoco 1, UNI 9177



Available Shell Color / Colori disponibili Scocca

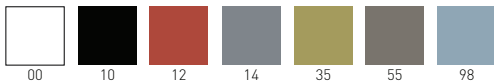

Frame Finishes / Finiture telaio

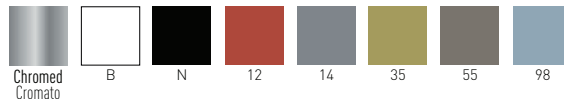

ARTESIA S



Chromed or Painted wire steel sled frame, techno-polymer shell.
Struttura a slitta in filo, cromata o verniciata, scocca in tecnopolimero.

CATAS
TESTATO - TESTED

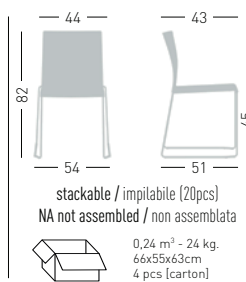

Frame Finishing & Codes / Finiture Telaie e Codici

- cod. 110.--/S chromed/cromata
- cod. 110.--/SB white painted/verniciato bianco
- cod. 110.--/SN black painted/verniciato nero
- cod. 110.--/S55 mineral grey painted/verniciato grigio minerale
- cod. 110.--/S14 pearl grey painted/verniciato grigio perla
- cod. 110.--/S12 brick painted/verniciato mattone
- cod. 110.--/S35 lime painted/verniciato lime
- cod. 110.--/S98 pale blue painted/verniciato avio

DKK - kr

995
995
995
995
995
995
995
995

- cod. 110.00/IGNS-- Fire Retardant/Ignifuga Classe 1
- cod. 110.55/IGNS-- Fire Retardant/Ignifuga Classe 1
- cod. 110.14/IGNS-- Fire Retardant/Ignifuga Classe 1
- cod. 110.98/IGNS-- Fire Retardant/Ignifuga Classe 1

1.195
1.195
1.195
1.195

Fire Retardant minimum Order 20pcs
Ignifuga ordine Minimo 20pz

Black glides on black frames.
Neutral glides on other frame finishes.
Piedini neri su telai neri.
Piedini neutri nelle altre finiture telaio.

ARTESIA SS



Chromed or Painted wire steel sled frame with armrests, techno-polymer shell.
Struttura a slitta in filo con braccioli, cromata o verniciata, scocca in tecnopolimero.

The arm pads are in the same color of the shell.
Il copribrafcio è dello stesso colore della scocca.



Frame Finishing & Codes / Finiture Telai e Codici

cod. 110.--/SS chromed/cromata
cod. 110.--/SSN black painted/verniciato nero

DKK - kr

1.295
1.295

cod. 110.00-00/IGNSS chromed/cromata
Fire Retardant/Ignifuga Classe 1

1.495

cod. 110.00-00/IGNSSN black painted/verniciato nero
Fire Retardant/Ignifuga Classe 1

1.495

cod. 110.55-55/IGNSS chromed/cromata
Fire Retardant/Ignifuga Classe 1

1.495

cod. 110.55-55/IGNSSN black painted/verniciato nero
Fire Retardant/Ignifuga Classe 1

1.495

cod. 110.14-14/IGNSS chromed/cromata
Fire Retardant/Ignifuga Classe 1

1.495

cod. 110.14-14/IGNSSN black painted/verniciato nero
Fire Retardant/Ignifuga Classe 1

1.495

cod. 110.98-98/IGNSS chromed/cromata
Fire Retardant/Ignifuga Classe 1

1.495

cod. 110.98-98/IGNSSN black painted/verniciato nero
Fire Retardant/Ignifuga Classe 1

1.495

Fire Retardant minimum Order 20pcs
Ignifuga ordine Minimo 20pz

Black glides on black frames.
Neutral glides on other frame finishes.
Piedini neri su telai neri.
Piedini neutri nelle altre finiture telai.

ARTESIA TABLET / TAVOLETTA



Removable anti-panic tablet, chromed wire steel frame, die cast aluminum polished joint, techno-polymer arm and tablet.
Tavoletta antipanico removibile, telaio in filo di acciaio cromato, snodo in alluminio pulito, bracciolo e tavoletta in tecnopolimero.

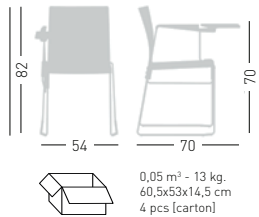

Frame Finishing & Codes / Finiture Telai e Codici

cod. 1210.__-G1 chromed frame/struttura cromata

DKK - kr

695

Min. order 4pcs
each code
Ordine min 4pz
per codice

Arm & Fittings colours / Colore bracciolo e fissaggi

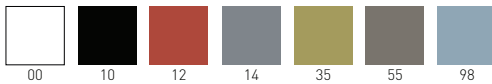

Tablet Color / Colore Tavoletta



ARTESIA NARROW CUSHION / CUSCINO STRETTO



Narrow upholstered cushion, suitable for chair stackability.
Cuscino tappezzato stretto, adatto a sedute che devono essere impilate.

Available fabric.
Tessuti disponibili.
B, E, K, DK
COM fabric / Tessuto cliente **TC** (10 pcs min)



0,450kg/pz
Inside chairs boxes
Inseriti nella scatola delle sedie

Frame Finishing & Codes / Finiture Telai e Codici

cod.330.-- (B)
cod.330.-- (E)
cod.330.-- (K)
cod.330.-- (DK)
cod.330.TC COM fabric/tessuto cliente

DKK - kr

625
550
550
650
475

Fabric required
Fabbisogno di tessuto
4 pcs: Lin Mtrs 1,0 (h1,40)

COM fabric min. order
10pcs each code
Tessuto cliente TC ordine
min. 10pz per codice

Min. order 4pcs
each code
Ordine min 4pz
per codice

ARTESIA WIDE CUSHION / CUSCINO LARGO



Large upholstered cushion.
Cuscino tappezzato largo.

Available fabric.
Tessuti disponibili.
B, E, K, DK
COM fabric / Tessuto cliente **TC**
(10 pcs min)



0,500kg/pz
Inside chairs boxes
Inseriti nella scatola delle sedie

Frame Finishing & Codes / Finiture Telai e Codici

cod.331.-- (B)
cod.331.-- (E)
cod.331.-- (K)
cod.331.-- (DK)
cod.331.TC COM fabric/tessuto cliente

DKK - kr

650
575
575
675
500

Fabric required
Fabbisogno di tessuto
4 pcs: Lin Mtrs 1,2 (h1,40)

COM fabric min. order
10pcs each code
Tessuto cliente TC ordine
min. 10pz per codice

Min. order 4pcs
each code
Ordine min 4pz
per codice

ARTESIA
FELT GLIDES
PIEDINI IN FELTRO



Felt glides for delicate surfaces.
Piedini in Feltro per superfici delicate.

NA not assembled / non assemblata



Inside chairs boxes
Inseriti nella confezione

Frame Finishing & Codes / Finiture Telai e Codici

cod.ACCS001.F

DKK - kr

75

ARTESIA
LINKING / AGGANCI



Set linking glides for in-line disposal.
Set piedini con agganci per disporre le sedute in linea.

Available for model S (even with tablet) and SS
Disponibile per versioni S (anche con tavoletta) e SS.

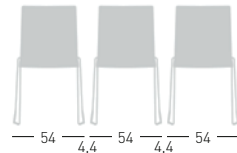

Inside chairs boxes
Inseriti nella scatola delle sedie

Frame Finishing & Codes / Finiture Telai e Codici

cod.1013 neutral/neutro
cod.1013.10 black/nero

DKK - kr

125
125

ARTESIA
CHAIR TROLLEY /
CARRELLO PER SEDIE



Trolley for Chairs with handle, painted black metal structure, heavy duty castors with brakes.

Carrello porta sedie con maniglia, struttura in metallo verniciata nera, ruote ad alta resistenza con freni.

Available for model S and SS
Disponibile per versioni S e SS

Stackable on trolley 50pcs (H210cm)
Impilabili su carrello 50pz (H210cm)



0,42 m³ - 11,50 kg.
74x58x97cm
1 pcs [carton]

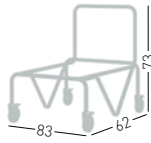

Frame Finishing & Codes / Finiture Telai e Codici

cod.2008/A

DKK - kr

3.575

ARTESIA
TABLET TROLLEY /
CARRELLO PER TAVOLETTE



Trolley for tablets, chromed metal structure, castors with brakes.
Carrello porta-tavolette, struttura in metallo cromato, ruote con freno.

Stackable on trolley 24 tablets
Accatatabili su carrello 24 tavolette



0,41 m³ - 14,5 kg.
74x57,5x96,5cm
1 pc [carton]

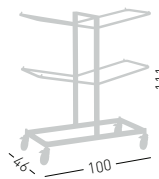

Frame Finishing & Codes / Finiture Telai e Codici

cod.2009/A

DKK - kr

5.275

Avenica



Available colors / Colori disponibili

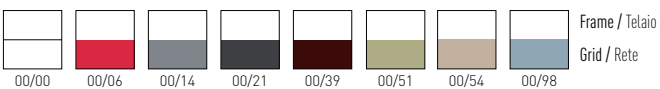
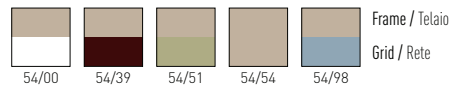
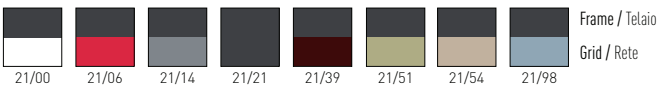

AVENICA



Techno-polymer twin-material chair with integrated armrests.
Sedia in tecnopolimero bi-materiale con braccioli integrati.

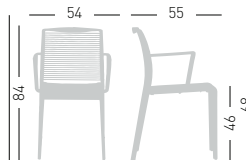

stackable / impilabile (6pcs)
A assembled / assemblato



0,46 m³ - 22 kg.
58x75x102cm.
4 pcs [carton]

Frame Finishing & Codes / Finiture Telai e Codici

cod.375.___/_/A

DKK - kr

1.295

Bakhita



Available colors / Colori disponibili

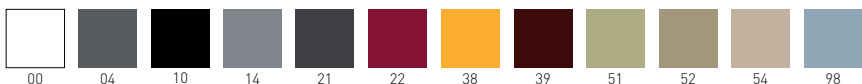

IGN Versions follows UNI 9177 certification in terms of Fire Resistance, Fire Reaction Class 1
Versioni IGN prodotto Omologato con Classe di Reazione al fuoco 1, UNI 9177



BAKHITA

Twin-material techno-polymer chair.
Sedia bi-materiale in tecnopolimero.

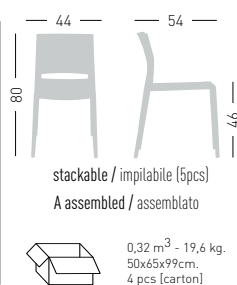

Frame Finishing & Codes / Finiture Telai e Codici

cod.370.--/A

cod.370.00/IGN white fire retardant/bianco ignifuga

Minimum order 20pcs/ Ordine minimo 20pz

cod.370.--/IGN fire retardant/ignifuga

Minimum order 300pcs/ Ordine minimo 300pz

DKK - kr

995

1.195

1.195

BAKHITA B

Twin-material techno-polymer chair
with integrated armrests.
Sedia bi-materiale in tecnopolimero
con braccioli integrati.

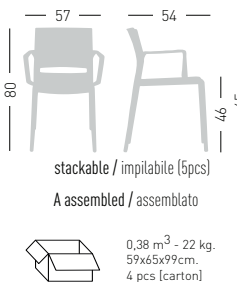

Frame Finishing & Codes / Finiture Telai e Codici

cod.371.--/A

cod.371.--/IGN fire retardant/ignifuga

Minimum order 300pcs/ Ordine minimo 300pz

DKK - kr

1.095

1.295

BAKHITA
CUSHION / CUSCINO



Bakhita cushion, complete with white under seat cover.
Cuscino Bakhita, completo di sottoscocca bianco.

Available fabric.
Tessuti disponibili.
B, E, K, DK, TC



0,5 kg.
Inside chairs boxes
Nella scatola delle sedie.

Frame Finishing & Codes / Finiture Telai e Codici

cod.311.-- (B)
cod.311.-- (E)
cod.311.-- (K)
cod.311.-- (DK)
cod.311.TC COM fabric/tessuto cliente

DKK - kr

675
600
600
700
525

Minimum order 4pcs each code
Ordine minimo 4 pezzi per codice

COM fabric minimum order 10pcs each code
Tessuto cliente TC ordine minimo 10pz per codice

Fabric required / Fabbisogno di tessuto
4 pcs : Lin Mtrs 1 (h1,40)

BAKHITA
CHAIRS TROLLEY
CARRELLO PER SEDIE



Trolley for 10 chairs model Bakhita, black painted.
Carrello porta 10 sedie modello Bakhita, verniciato nero.

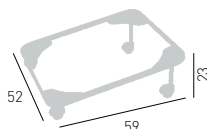

Frame Finishing & Codes / Finiture Telai e Codici

cod.2002/A

DKK - kr

1.275



0,09 m³ - 5,5kg
61x54x25cm.
1 pcs [carton]

BAKHITA
UNDERSEAT COVER
COPERTINA SOTTOSEDE



Bakhita underseat cover, white.
Sottoscocca Bakhita, colore bianco.



Inside chairs boxes
Nella scatola delle sedie.

Frame Finishing & Codes / Finiture Telai e Codici

cod.334.00

DKK - kr

125

BAKHITA
CONNECTING SYSTEM
GANCIO CONNESSIONE

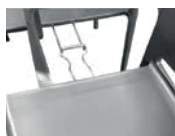

Extensible chromed linking devices for in line disposal, complete with underseat cover.
Agganci estensibili cromati per disporre le sedute in linea, con sottoscocca integrato.



Inside chairs boxes
Nella scatola delle sedie.

Assembled / assemblato

Frame Finishing & Codes / Finiture Telai e Codici

cod.1006

Minimum order 20pcs
Ordine minimo 20 pezzi

DKK - kr

325

available for models: Bakhita and Bakhita B
disponibile per versioni: Bakhita and Bakhita B

Basket



Available colors / Colori disponibili

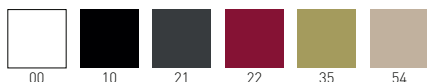

BASKET CHAIR NA



Chromed or painted 4-Legged metal frame, techno-polymer shell.
Struttura in metallo 4 gambe, cromata o verniciata, scocca in tecnopolimero.



only for painted frames
solo per telai verniciati

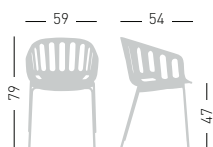

stackable / impilabile (4pcs)

NA not assembled / non assemblato



0,27 m³ - 21,60 kg.
64x64x64cm.
4 pcs [carton]

Frame Finishing & Codes / Finiture Telai e Codici

cod.268.--/NA chromed/cromata
cod.268.--/NAN black painted/verniciato nero
cod.268.--/NAB white painted/verniciato bianco
cod.268.--/NA21 painted/verniciato
cod.268.--/NA22 painted/verniciato
cod.268.--/NA35 painted/verniciato
cod.268.--/NA54 painted/verniciato

DKK - kr

995
1.195
1.195
1.195
1.195
1.195

Available Painted Frame Colors / Colori disponibili Telaio Verniciato

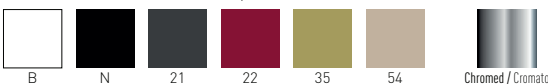

BASKET CHAIR BP



4 polymer-steel co-injected legs structure, techno-polymer shell.
Struttura 4 gambe in co-iniezione metallo-polimero, scocca in tecnopolimero.

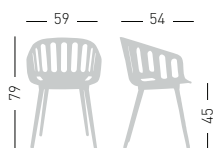

NA not assembled / non assemblato



0,24 m³ - 23,60 kg.
55x65,5x63cm.
4 pcs [carton]

Frame Finishing & Codes / Finiture Telai e Codici

cod.268.--/BP--

DKK - kr

1.595

Legs and shells colors can be combined
I colori delle gambe possono essere abbinati alla scocca

Available Legs Color / Colori disponibili Gambe

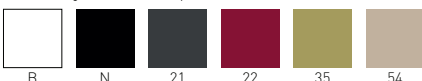

BASKET CHAIR CTL



Chromed or black painted cantilevered metal frame, techno-polymer shell.
Struttura in metallo cantilever, cromata o verniciata nera, scocca in tecnopolimero.



only for painted frames
solo per telai verniciati

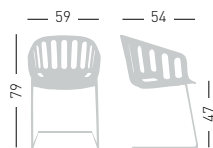

NA not assembled / non assemblato



0,18+0,24 m³ - 22,40 kg.
60x56x51cm.
66x55x63cm.
4 pcs [carton]

Frame Finishing & Codes / Finiture Telai e Codici

cod.268.--/CTL chromed/cromata
cod.268.--/CTLN black painted/verniciato nero

DKK - kr

1.295
1.395

BASKET CHAIR ST



Chromed or black painted sled steel frame, techno-polymer shell.
Struttura a slitta, cromata o verniciata nera, scocca in tecnopolimero.



only for painted frames
solo per telai verniciati

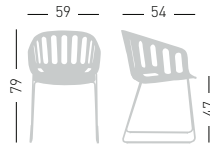

NA not assembled / non assemblato

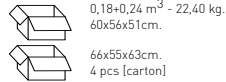

Frame Finishing & Codes / Finiture Telai e Codici

cod.268.--/ST chromed/cromata
cod.268.--/STN black painted/verniciato nero

DKK - kr

1.195
1.395

BASKET CHAIR BL



4-Legged wooden beech frame, techno-polymer shell.
Struttura in legno di faggio 4 gambe, scocca in tecnopolimero.

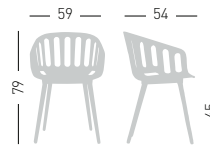
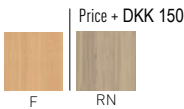

NA not assembled / non assemblato

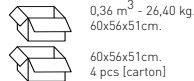

Frame Finishing & Codes / Finiture Telai e Codici

cod.268.--/BL_

Felt Glides / Tappi in feltro

DKK - kr

1.895

BASKET CHAIR U



Swivel on 4-blade aluminum painted base, with glides.
Girevole su basamento verniciato in alluminio a 4 razze su piedini.

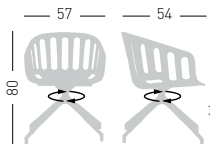

NA not assembled / non assemblato

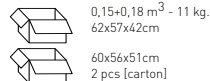

Frame Finishing & Codes / Finiture Telai e Codici

cod.268.--/UB white painted/verniciato bianco
cod.268.--/UN black painted/verniciato nero

Felt Glides / Tappi in feltro

DKK - kr

2.295
2.295

BASKET CHAIR UR



Swivel on 4-blade aluminum painted base, with castors.
Girevole su basamento verniciato in alluminio a 4 razze su ruote.

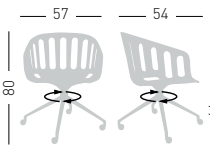

NA not assembled / non assemblato

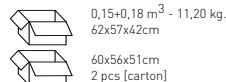

Frame Finishing & Codes / Finiture Telai e Codici

cod.268.--/URB white painted/verniciato bianco
cod.268.--/URN black painted/verniciato nero

DKK - kr

2.395
2.395

BASKET PL



4-legged wooden swivel base with solid Oak spokes reinforced with inner steel structure, techno-polymer shell.
Base girevole con quattro razze in rovere massello, rinforzate con struttura in acciaio interna, scocca in tecnopolimero.

Oak Essence / Essenza Rovere

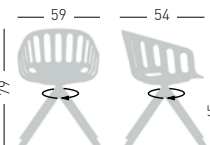

A assembled / assemblato



Frame Finishing & Codes / Finiture Telai e Codici

cod. 268._/PLRN Oak/Rovere

DKK - kr

3.395

BASKET CHAIR
CUSHION / CUSCINO



Removable upholstered cushion.
Cuscino tappezzato removibile.

Available fabric.
Tessuti disponibili.

E, K, DK
COM fabric / Tessuto cliente **TC**



0,7 kg.
Inside chairs
boxes
Nella scatola
delle sedie

Frame Finishing & Codes / Finiture Telai e Codici

cod.309.-- (E)
cod.309.-- (K)
cod.309.-- (DK)
cod.309.TC COM fabric/tessuto cliente

DKK - kr

1.775
1.775
2.275
1.375

Fabric required
Fabbisogno di tessuto
1 pcs: Lin Mtrs 1,8 (h1,40)

COM fabric min. order
10pcs each code
Tessuto cliente TC ordine
min. 10pz per codice

Min. order 4pcs
each code
Ordine min 4pz
per codice

BASKET CHAIR
SMOOTH CUSHION /
CUSCINO



Removable upholstered cushion
"Smooth" version.
Cuscino Tappezzato removibile, versione
"Smooth".

Available fabric.
Tessuti disponibili.

E, K, DK
COM fabric / Tessuto cliente **TC**



1 kg.
Inside chair
boxes.
Nella scatola
delle sedie.

Frame Finishing & Codes / Finiture Telai e Codici

cod.329.--(E)
cod.329.--(K)
cod.329.--(DK)
cod.329.TC COM fabric/tessuto cliente

DKK - kr

1.775
1.775
2.275
1.375

Fabric required
Fabbisogno di tessuto
1 pc: Lin Mtrs 1,8 (h1,40)

COM fabric min. order
10pcs each code
Tessuto cliente TC ordine
min. 10pz per codice

Min. order 4pcs
each code
Ordine min 4pz
per codice

BASKET UPHOLSTERED IMBOTTITE

Available coverings / Finiture disponibili
 King fabric / Tessuto King **K** (4pcs min.)
 Blazer fabric / Tessuto Blazer **B** (4pcs min.)
 Superb Trevira Velvet / Velluto Superb Trevira **S** (4pcs min.)
 Kvadrat fabrics / Tessuti Kvadrat **DK** (4pcs min.)
 Aurea eco-leather / Ecopelle aurea **E** (4pcs min.)
 COM fabric / Tessuto cliente **TC** (10pcs min.)
 Twin color upholstery details available on request /
 Dettagli tappezzeria bi-colore disponibili su richiesta

Products follows UNI 9175 -UNI 9175/FA, in terms of Fire Resistance, Fire Reation Class 1IM
 Prodotto Omologato dal Ministero dell'Interno , secondo la UNI 9175 -UNI 9175/FA, con classe di Reazione al fuoco 1IM



BASKET CHAIR NA UPHOLSTERED



Upholstered PU-FLEX shell,
 chromed or painted metal frame.
 Scocca in PU-FLEX rivestita,
 telaio in metallo cromato o verniciato.

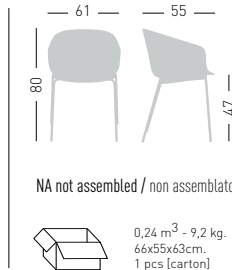

Frame Finishing & Codes / Finiture Telai e Codici

cod.268.--/IBNA chromed/cromata	DKK - kr	3.995
cod.268.--/IBNAN black painted/verniciato nero		4.195
cod.268.--/IBNAB white painted/verniciato bianco		4.195
cod.268.--/IBNA21 painted/verniciata		4.195
cod.268.--/IBNA22 painted/verniciata		4.195
cod.268.--/IBNA35 painted/verniciata		4.195
cod.268.--/IBNA54 painted/verniciata		4.195
cod.268.--/IKNA chromed/cromata		3.495
cod.268.--/IKNAN black painted/verniciato nero		3.595
cod.268.--/IKNAB white painted/verniciato bianco		3.595
cod.268.--/IKNA21 painted/verniciata		3.595
cod.268.--/IKNA22 painted/verniciata		3.595
cod.268.--/IKNA35 painted/verniciata		3.595
cod.268.--/IKNA54 painted/verniciata		3.595
cod.268.--/ISNA chromed/cromata		3.995
cod.268.--/ISNAN black painted/verniciato nero		4.195
cod.268.--/ISNAB white painted/verniciato bianco		4.195
cod.268.--/ISNA21 painted/verniciata		4.195
cod.268.--/ISNA22 painted/verniciata		4.195
cod.268.--/ISNA35 painted/verniciata		4.195
cod.268.--/ISNA54 painted/verniciata		4.195
cod.268.--/IDKNA chromed/cromata		4.295
cod.268.--/IDKNAN black painted/verniciato nero		4.495
cod.268.--/IDKNAB white painted/verniciato bianco		4.495
cod.268.--/IDKNA21 painted/verniciata		4.495
cod.268.--/IDKNA22 painted/verniciata		4.495
cod.268.--/IDKNA35 painted/verniciata		4.495
cod.268.--/IDKNA54 painted/verniciata		4.495
cod.268.--/IENA chromed/cromata		3.495
cod.268.--/IENAN black painted/verniciato nero		3.595
cod.268.--/IENAB white painted/verniciato bianco		3.595
cod.268.--/IENA21 painted/verniciata		3.595
cod.268.--/IENA22 painted/verniciata		3.595
cod.268.--/IENA35 painted/verniciata		3.595
cod.268.--/IENA54 painted/verniciata		3.595
cod.268/ITCNA chromed/cromata		3.195
cod.268/ITCNA- painted/verniciata		3.395

Available Painted Frame Colors / Colori disponibili Telaio Verniciato

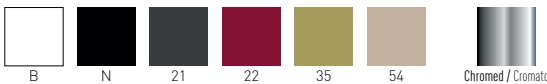

Fabric required
 Fabbisogno di tessuto
 1 pcs: Lin Mtrs 1,3 (h1,40)

COM fabric min. order
 10pcs each code
 Tessuto cliente TC ordine
 min. 10pz per codice

Min. order 4pcs
 each code
 Ordine min 4pz
 per codice

BASKET CHAIR ST UPHOLSTERED



Upholstered PU-FLEX shell,
 chromed or painted metal frame.
 Scocca in PU-FLEX rivestita,
 telaio in metallo cromato o verniciato.

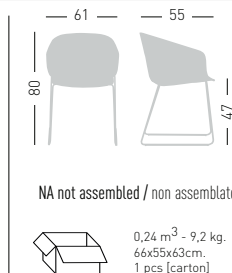

Frame Finishing & Codes / Finiture Telai e Codici

cod.268.--/IBST chromed/cromata	DKK - kr	4.095
cod.268.--/IBSTN black painted/verniciato nero		4.195
cod.268.--/IKST chromed/cromata		3.595
cod.268.--/IKSTN black painted/verniciato nero		3.695
cod.268.--/ISST chromed/cromata		4.095
cod.268.--/ISSTN black painted/verniciato nero		4.195
cod.268.--/IDKST chromed/cromata		4.395
cod.268.--/IDKSTN black painted/verniciato nero		4.595
cod.268.--/IEST chromed/cromata		3.595
cod.268.--/IESTN black painted/verniciato nero		3.695
cod.268/ITCST chromed/cromata		3.295
cod.268/ITCSTN black painted/verniciato nero		3.395

Fabric required
 Fabbisogno di tessuto
 1 pcs: Lin Mtrs 1,3 (h1,40)

COM fabric min. order
 10pcs each code
 Tessuto cliente TC ordine
 min. 10pz per codice

Min. order 4pcs
 each code
 Ordine min 4pz
 per codice

BASKET CHAIR CTL UPHOLSTERED



Upholstered PU-FLEX shell, chromed or painted metal frame. Scocca in PU-FLEX rivestita, telaio in metallo cromato o verniciato.

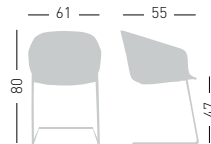

NA not assembled / non assemblato



0,24 m³ - 9,2 kg.
66x55x63cm.
1 pcs [carton]

Frame Finishing & Codes / Finiture Telai e Codici

cod.268.--/IBCTL chromed/cromata
cod.268.--/IBCTLN black painted/verniciato nero
cod.268.--/IKCTL chromed/cromata
cod.268.--/IKCTLN black painted/verniciato nero
cod.268.--/ISCTL chromed/cromata
cod.268.--/ISCTLN black painted/verniciato nero
cod.268.--/IDKCTL chromed/cromata
cod.268.--/IDKCTLN black painted/verniciato nero
cod.268.--/IECTL chromed/cromata
cod.268.--/IECTLN black painted/verniciato nero
cod.268/ITCCTL chromed/cromata
cod.268/ITCCTLN black painted/verniciato nero

DKK - kr

4.095
4.195
3.595
3.695
4.095
4.195
4.495
4.595
3.595
3.695
3.295
3.495

Fabric required
Fabbisogno di tessuto
1 pcs: Lin Mtrs 1,3 (h1,40)

COM fabric min. order
10pcs each code
Tessuto cliente TC ordine
min. 10pz per codice

Min. order 4pcs
each code
Ordine min 4pz
per codice

BASKET CHAIR BP UPHOLSTERED



Upholstered PU-FLEX shell, metal-polymer co-injected frame. Scocca in PU-FLEX rivestita, telaio 4 gambe co-iniettate metallo-polimero.

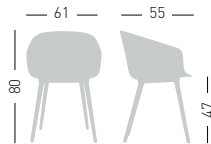

NA not assembled / non assemblato



0,18 m³ - 9,7 kg.
59,5x56,5x51,5cm.
1 pcs [carton]

Frame Finishing & Codes / Finiture Telai e Codici

cod.268.--/IBBP--
cod.268.--/IKBP--
cod.268.--/ISBP--
cod.268.--/IDKBP--
cod.268.--/IEBP--
cod.268/ITCBP--

DKK - kr

4.495
3.895
4.495
4.795
3.895
3.695

Fabric required
Fabbisogno di tessuto
1 pcs: Lin Mtrs 1,3 (h1,40)

COM fabric min. order
10pcs each code
Tessuto cliente TC ordine
min. 10pz per codice

Min. order 4pcs
each code
Ordine min 4pz
per codice

Available Legs Color / Colori disponibili Gambe

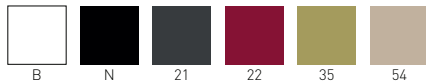

BASKET CHAIR BL UPHOLSTERED



Upholstered PU-FLEX shell, beech wooden frame. Scocca in PU-FLEX rivestita, telaio in legno di faggio.

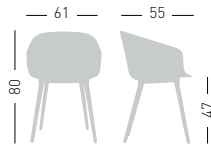

NA not assembled / non assemblato



0,78 m³ - 41,00 kg.
60x56x51cm.



62x57x42cm.
4 pcs [carton]

Frame Finishing & Codes / Finiture Telai e Codici

cod.268.--/IBBL_
cod.268.--/IKBL_
cod.268.--/ISBL_
cod.268.--/IDKBL_
cod.268.--/IEBL_
cod.268/ITCBL_

DKK - kr

4.695
4.195
4.695
4.995
4.195
3.895

Felt Glides / Tappi in feltro

Fabric required
Fabbisogno di tessuto
1 pcs: Lin Mtrs 1,3 (h1,40)

COM fabric min. order
10pcs each code
Tessuto cliente TC ordine
min. 10pz per codice

Min. order 4pcs
each code
Ordine min 4pz
per codice

Price + DKK 150



BASKET CHAIR U UPHOLSTERED



Upholstered PU-FLEX shell, aluminium base. Scocca in PU-FLEX rivestita, base in alluminio.

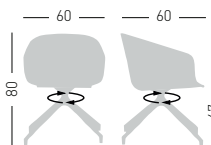

NA not assembled / non assemblato



0,33 m³ - 9,2 kg.
60x56x51cm.



62x57x42cm
1 pcs [carton]

Frame Finishing & Codes / Finiture Telai e Codici

cod.268.--/IBUL polished/lucido
cod.268.--/IBUB white/bianco
cod.268.--/IBUN black/nero
cod.268.--/IKUL polished/lucido
cod.268.--/IKUB white/bianco
cod.268.--/IKUN black/nero
cod.268.--/ISUL polished/lucido
cod.268.--/ISUB white/bianco
cod.268.--/ISUN black/nero
cod.268.--/IDKUL polished/lucido
cod.268.--/IDKUB white/bianco
cod.268.--/IDKUN black/nero
cod.268.--/IEUL polished/lucido
cod.268.--/IEUB white/bianco
cod.268.--/IEUN black/nero
cod.268/ITCUL polished/lucido
cod.268/ITCUB white/bianco
cod.268/ITCUN black/nero

DKK - kr

5.295
5.195
5.195
4.695
4.595
4.595
5.295
5.195
5.195
5.595
5.495
5.495
4.695
4.595
4.595
4.495
4.395
4.395

Felt Glides / Tappi in feltro

Fabric required
Fabbisogno di tessuto
1 pcs: Lin Mtrs 1,3 (h1,40)

COM fabric min. order
10pcs each code
Tessuto cliente TC ordine
min. 10pz per codice

Min. order 4pcs
each code
Ordine min 4pz
per codice

**BASKET
CHAIR UR
UPHOLSTERED**



Upholstered PU-FLEX shell,
aluminium base with castors.
Scocca in PU-FLEX rivestita,
base in alluminio con ruote.

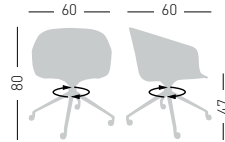

NA not assembled / non assemblato

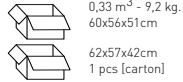

0,33 m³ - 9,2 kg.
60x56x51cm
62x57x42cm
1 pcs [carton]

Frame Finishing & Codes / Finiture Telai e Codici

cod.268.--/IBURL polished/lucido
cod.268.--/IBURB white/bianco
cod.268.--/IBURN black/nero
cod.268.--/IKURL polished/lucido
cod.268.--/IKURB white/bianco
cod.268.--/IKURN black/nero
cod.268.--/ISURL polished/lucido
cod.268.--/ISURB white/bianco
cod.268.--/ISURN black/nero
cod.268.--/IDKURL polished/lucido
cod.268.--/IDKURB white/bianco
cod.268.--/IDKURN black/nero
cod.268.--/IEURL polished/lucido
cod.268.--/IEURB white/bianco
cod.268.--/IEURN black/nero
cod.268/ITCURL polished/lucido
cod.268/ITCURB white/bianco
cod.268/ITCURN black/nero

DKK - kr

5.395
5.295
5.295
4.895
4.695
4.695
5.395
5.295
5.295
5.795
5.595
5.595
4.895
4.695
4.695
4.595
4.495
4.495

Fabric required
Fabbisogno di tessuto
1 pcs: Lin Mtrs 1,3 (h1,40)

COM fabric min. order
10pcs each code
Tessuto cliente TC ordine
min. 10pz per codice

Min. order 4pcs
each code
Ordine min 4pz
per codice

**BASKET PL
UPHOLSTERED**



4-legged wooden swivel base with
solid Oak spokes reinforced with
inner steel structure, techno-polymer
shell and upholstered cushion.
Base girevole con quattro razze
in rovere massello rinforzate con
struttura in acciaio interna, scocca in
tecnopolimero e cuscino tappezzato.

Oak Essence / Essenza Rovere



RN

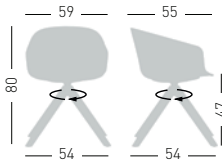

A assembled / assemblato



0,30 m³ - 12,5 kg.
56x60x92cm.
1 pc [carton]

Frame Finishing & Codes / Finiture Telai e Codici

cod. 268.__/IKPLRN Oak/Rovere
cod. 268.__/IBPLRN Oak/Rovere
cod. 268.__/ISPLRN Oak/Rovere
cod. 268.__/IDKPLRN Oak/Rovere
cod. 268.__/IEPLRN Oak/Rovere
cod. 268/ITCPLRN Oak/Rovere

DKK - kr

5.795
6.095
5.795
6.595
5.795
5.595

Fabric required
Fabbisogno di tessuto
1 pc: Lin Mtrs 1,3 (h1,40)

COM fabric min. order
10pcs each code
Tessuto cliente TC ordine
min. 10pz per codice

Min. order 4pcs
each code
Ordine min 4pz
per codice

Beverly



Available colors / Colori disponibili

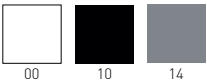

BEVERLY

Shell in techno-polymer and anodized aluminum legs.
Scocca in tecnopolimero e gambe in alluminio anodizzato.



CATAS
TESTATO - TESTED

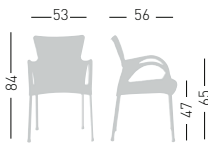

stackable / impilabile (5pcs)

A assembled / assemblato



0,41 m³ - 15,2 kg.
95x73x60,5cm.
4 pcs [carton]

Frame Finishing & Codes / Finiture Telai e Codici

cod.35.--/A

DKK - kr

795

Big Bang



Available colors / Colori disponibili

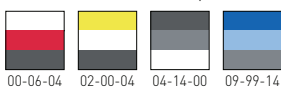

BIG BANG

Chromed or white painted 4-Legged metal frame, techno-polymer multicolor shell.

Struttura in metallo 4 gambe, cromata o verniciata bianca, scocca in tecnopolimero multicolore.

CATAS
TESTATO - TESTED



only for painted frames
solo per telai verniciati

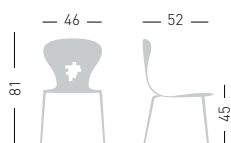

stackable / impilabile (5pcs)

A assembled / assemblato



0,30 m³ - 20 kg.
61x55x96cm.
4 pz. (carton)

Frame Finishing & Codes / Finiture Telai e Codici

cod.93.--/A chromed/cromata

cod.93.--/AB white painted/verniciato bianco

DKK - kr

1.195

1.295

Blog



Available colors / Colori disponibili

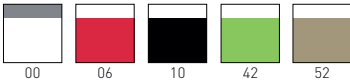

BLOG



Chromed or white painted 4-Legged metal frame, techno-polymer multicolor shell.
Struttura in metallo 4 gambe, cromata o verniciata bianca, scocca in tecnopolimero multicolore.



only for paintend frames
solo per telai verniciati

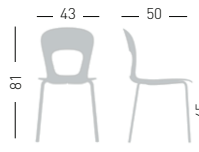

stackable / impilabile (5pcs)

A assembled / assemblato



0,30 m³ - 19,60 kg.
61x55x96cm.
4 pcs [carton]

Frame Finishing & Codes / Finiture Telai e Codici

cod.144.--/A chromed/cromata
cod.144.--/AB white painted/verniciato bianco

DKK - kr

1.095
1.295

BLOG TB



Chromed 4-Legged metal frame with armrests, techno-polymer multicolor shell.
Struttura in metallo 4 gambe con braccioli, cromata, scocca in tecnopolimero multicolore.



only for paintend frames
solo per telai verniciati

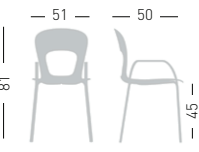

stackable / impilabile (5pcs)

A assembled / assemblato



0,31 m³ - 12 kg.
58x53,5x91,5cm.
2 pcs [carton]

Frame Finishing & Codes / Finiture Telai e Codici

cod.144.--/TB chromed/cromata

DKK - kr

1.595

BLOG BL



4-Legged wooden beech frame, techno-polymer multicolor shell.
Struttura in legno di faggio 4 gambe, scocca in tecnopolimero multicolore.



Price + DKK 150

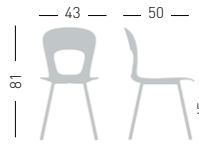

NA not assembled / non assemblato



[1x] 0,36 m³ - 21,60 kg.
50x50x48cm.
[2x] 50x50x48cm.
4 pcs [carton]

Frame Finishing & Codes / Finiture Telai e Codici

cod.144.--/BL_

Felt Glides / Tappi in feltro

DKK - kr

1.895

BLOG UPHOLSTERED IMBOTTITE

Available fabric / Tessuti disponibili
Leather / Pelle **P** (4pcs min.)
King fabric / Tessuto King **K** (4pcs min.)
COM fabric / Tessuto cliente **TC** (10pcs min.)

BLOG NA UPHOLSTERED



Techno-polymer shell upholstered by King fabric or leather. Chromed or painted metal frame.
Scocca in tecnopolimero rivestito in tessuto King o pelle. Telaio in metallo cromato o verniciato.

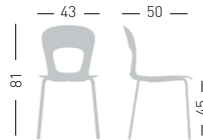

A assembled / assemblato



0,30 m³ - 11 kg,
62,5x46x97cm,
2 pcs (carton)

Frame Finishing & Codes / Finiture Telai e Codici

cod.175.--/IPNA chromed/cromata
cod.175.--/IKNA chromed/cromata
cod.175.--/ITCNA chromed/cromata
cod.175.--/IPNAB white painted/verniciato bianco
cod.175.--/IKNAB white painted/verniciato bianco
cod.175/ITCNAB white painted/verniciato bianco

DKK - kr

3.595
3.095
2.795
3.795
3.195
2.995

Fabric required
Fabbisogno di tessuto
1 pcs: Lin Mtrs 1,3 (h1,40)

COM fabric min. order
10pcs each code
Tessuto cliente TC ordine
min. 10pz per codice

Min. order 4pcs
each code
Ordine min 4pz
per codice

BLOG TB UPHOLSTERED



Techno-polymer shell upholstered by King fabric or leather. Chromed metal frame with arms.
Scocca in tecnopolimero rivestito in tessuto King o pelle. Telaio in metallo cromato con braccioli.

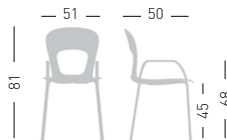

A assembled / assemblato



0,31 m³ - 7,0 kg,
58x53,5x91cm,
1 pcs (carton)

Frame Finishing & Codes / Finiture Telai e Codici

cod.175.--/IPTB chromed/cromata
cod.175.--/IKTB chromed/cromata
cod.175/ITCTB chromed/cromata

DKK - kr

4.295
3.795
3.495

Fabric required
Fabbisogno di tessuto
1 pcs: Lin Mtrs 1,3 (h1,40)

COM fabric min. order
10pcs each code
Tessuto cliente TC ordine
min. 10pz per codice

Min. order 4pcs
each code
Ordine min 4pz
per codice

BLOG BL UPHOLSTERED



Techno-polymer shell upholstered by King fabric or leather and beech wooden legs.
Scocca in tecnopolimero rivestito in tessuto King o pelle e gambe in legno di faggio.



NA not assembled / non assemblato



0,36 m³ - 21,60 kg,
50x50x48cm.



50x50x48cm,
4 pcs (carton)

Frame Finishing & Codes / Finiture Telai e Codici

cod.175.--/IPBL_
cod.175.--/IKBL_
cod.175/ITCBL_

DKK - kr

3.995
3.495
3.195

Felt Glides / Tappi in feltro

Fabric required
Fabbisogno di tessuto
1 pcs: Lin Mtrs 1,3 (h1,40)

COM fabric min. order
10pcs each code
Tessuto cliente TC ordine
min. 10pz per codice

Min. order 4pcs
each code
Ordine min 4pz
per codice

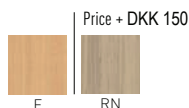

Chevalet



Products follows UNI 9175 -UNI 9175/FA, in terms of Fire Resistance, Fire Reation Class 11M
 Prodotto Omologato dal Ministero dell'Interno , secondo la UNI 9175 -UNI 9175/FA, con classe di Reazione al fuoco 11M



Available fabric / Tessuti disponibili
 Blazer fabric / Tessuto Blazer **B** (4pcs min.)
 Leather / Pelle **P** (4pcs min.)
 King fabric / Tessuto King **K** (4pcs min.)
 Kvadrat fabrics / Tessuti Kvadrat **DK** (4pcs min.)
 COM fabric / Tessuto cliente **TC**

CHEVALET BL

PU-FLEX shell upholstered by King, Blazer, Kvadrat fabric or leather and wooden beech legs.
 Scocca PU-FLEX rivestita in tessuto King, Blazer, Kvadrat o pelle, gambe in legno di faggio.

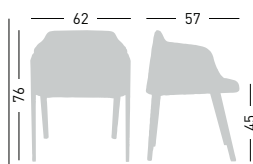

A assembled / assemblato



0,29 m³ - 11 kg.
 63x57x80cm.
 1 pc (carton)

Frame Finishing & Codes / Finiture Telai e Codici

cod.248.--/IBBLF beech/faggio
cod.248.--/IKBLF beech/faggio
cod.248.--/IDKBLF beech/faggio
cod.248.--/IPBLF beech/faggio
cod.248/ITCBLF beech/faggio

Felt Glides / Tappi in feltro

specify edge color
 specificare il colore del bordo

Fabric required
 Fabbisogno di tessuto
 1 pcs: Lin Mtrs 1,8 (h1,40)

DKK - kr

6.595
5.995
6.995
6.995
5.695

COM fabric min. order
 10pcs each code
 Tessuto cliente TC ordine
 min. 10pz per codice

Min. order 4pcs
 each code
 Ordine min 4pz
 per codice



Choppy

Available coverings / Finiture disponibili
 Miki fabric / Tessuto Miki **M** (4pcs min.)
 King fabric / Tessuto King **K** (4pcs min.)
 Kvadrat fabrics / Tessuti Kvadrat **DK** (4pcs min.)
 Silvertex Fabric / Tessuto Silvertex **SX** (4pcs min.)

CHOPPY BL

Techno-polymer upholstered chair,
 4-Legged wooden beech frame.
 Seduta in tecnopolimero rivestita,
 struttura in legno di faggio 4 gambe.

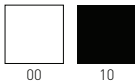

Cushion-edge color combined with the shell
 Colore del bordo cuscino uguale al colore scocca

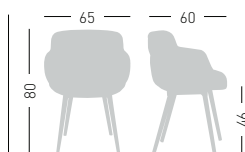

NA not assembled / non assemblato
 0,42 m³ - 36,00 kg.
 66x55x63cm.
 60x56x51cm.
 4 pcs [carton]

Frame Finishing & Codes / Finiture Telai e Codici

cod.390.00- ----/IMBL_ white/bianca
 cod.390.10- ----/IMBL_ black/nera
 cod.390.00- ----/IKBL_ white/bianca
 cod.390.10- ----/IKBL_ black/nera
 cod.390.00- ----/ISXBL_ white/bianca
 cod.390.10- ----/ISXBL_ black/nera
 cod.390.00- ----/IDKBL_ white/bianca
 cod.390.10- ----/IDKBL_ black/nera

DKK - kr

4.795
 4.795
 4.795
 4.795
 4.795
 5.995
 5.995

Felt Glides / Tappi in feltro

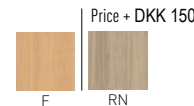

Price + DKK 150

Min. order 4pcs
 each code
 Ordine min 4pz
 per codice

CHOPPY BP

Techno-polymer upholstered chair,
 4 polymer-steel co-injected legs
 structure.
 Seduta in tecnopolimero rivestita,
 struttura 4 gambe in co-iniezione
 metallo-polimero.



only for Miki and Silvertex fabrics
 solo per tessuto Miki e Silvertex

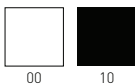

Cushion-edge color combined with the shell
 Colore del bordo cuscino uguale al colore scocca

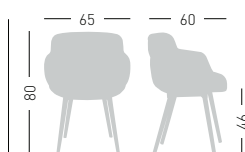

NA not assembled / non assemblato
 0,24 m³ - 20 kg.
 66x55x63cm.
 2 pcs [carton]

Frame Finishing & Codes / Finiture Telai e Codici

cod.390.00- ----/IMBP00 white/bianca
 cod.390.10- ----/IMBP10 black/nera
 cod.390.00- ----/IKBP00 white/bianca
 cod.390.10- ----/IKBP10 black/nera
 cod.390.00- ----/ISXBP00 white/bianca
 cod.390.10- ----/ISXBP10 black/nera
 cod.390.00- ----/IDKBP00 white/bianca
 cod.390.10- ----/IDKBP10 black/nera

DKK - kr

4.695
 4.695
 4.695
 4.695
 4.695
 4.695
 5.995
 5.995

Min. order 4pcs
 each code
 Ordine min 4pz
 per codice

CHOPPY U

Techno-polymer upholstered chair,
 swivel on 4-blade, with glides.
 Seduta in tecnopolimero rivestita,
 girevole su basamento a 4 razze su
 piedini.

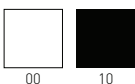

Cushion-edge color combined with the shell
 Colore del bordo cuscino uguale al colore scocca

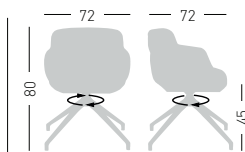

NA not assembled / non assemblato
 0,42 m³ - 26 kg.
 60x56x51cm.
 66x55x63cm.
 2 pcs [carton]

Frame Finishing & Codes / Finiture Telai e Codici

cod.390.00- ----/IMUB white/bianca
 cod.390.10- ----/IMUN black/nera
 cod.390.00- ----/IKUB white/bianca
 cod.390.10- ----/IKUN black/nera
 cod.390.00- ----/ISXUB white/bianca
 cod.390.10- ----/ISXUN black/nera
 cod.390.00- ----/IDKUB white/bianca
 cod.390.10- ----/IDKUN black/nera

DKK - kr

5.195
 5.195
 5.195
 5.195
 5.195
 5.195
 6.495
 6.495

Felt Glides / Tappi in feltro

Min. order 4pcs
 each code
 Ordine min 4pz
 per codice

CHOPPY UR



Techno-polymer upholstered chair, swivel on 4-blade, with castors. Seduta in tecnopolimero rivestita, girevole su basamento a 4 razze su ruote.

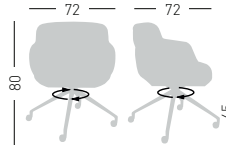

NA not assembled / non assemblato

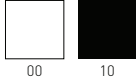
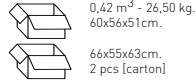

Cushion-edge color combined with the shell
Colore del bordo cuscino uguale al colore scocca

Frame Finishing & Codes / Finiture Telai e Codici

cod.390.00- ----/IMURB white/bianca
cod.390.10- ----/IMURN black/nera
cod.390.00- ----/IKURB white/bianca
cod.390.10- ----/IKURN black/nera
cod.390.00- ----/ISXURB white/bianca
cod.390.10- ----/ISXURN black/nera
cod.390.00- ----/IDKURB white/bianca
cod.390.10- ----/IDKURN black/nera

DKK - kr

5.295
5.295
5.295
5.295
5.295
6.495
6.495

Min. order 4pcs
each code
Ordine min 4pz
per codice

CHOPPY PL



Techno-polymer upholstered chair, 4-legged wooden swivel base with solid Oak spokes reinforced with inner steel structure. Seduta in tecnopolimero rivestita, base girevole con quattro razze in rovere massello, rinforzate con struttura interna in acciaio.

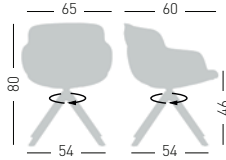

A assembled / assemblato



Oak Essence / Essenza Rovere



Frame Finishing & Codes / Finiture Telai e Codici

cod. 390.00- ___/IMPLRN white/bianca
cod. 390.10- ___/IMPLRN black/nera
cod. 390.00- ___/IKPLRN white/bianca
cod. 390.10- ___/IKPLRN black/nera
cod. 390.00- ___/ISXPLRN white/bianca
cod. 390.10- ___/ISXPLRN black/nera
cod. 390.00- ___/IDKPLRN white/bianca
cod. 390.10- ___/IDKPLRN black/nera

DKK - kr

6.295
6.295
6.295
6.295
6.295
6.295
6.895
6.895



Choppy Sleek

Available coverings / Finiture disponibili
Blazer fabric / Tessuto Blazer **B** (4pcs min.)
Aurea eco-leather / Ecopelle aurea **E** (4pcs min.)
King fabric / Tessuto King **K** (4pcs min.)
Kvadrat fabrics / Tessuti Kvadrat **DK** (4pcs min.)
COM fabric / Tessuto cliente **TC** (10pcs min.)

Products follows UNI 9175 -UNI 9175/FA, in terms of Fire Resistance, Fire Reation Class 11M
Prodotto Omologato dal Ministero dell'Interno, secondo la UNI 9175 -UNI 9175/FA, con classe di Reazione al fuoco 11M



CHOPPY SLEEK BL



Techno-polymer upholstered chair, 4-Legged wooden beech frame. Seduta in tecnopolimero rivestita, struttura in legno di faggio 4 gambe.

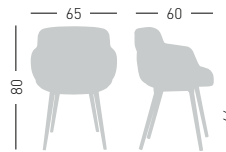

NA not assembled / non assemblato

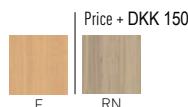

Price + DKK 150

Frame Finishing & Codes / Finiture Telai e Codici

cod.391.00- ----/IBBL_ white/bianca
cod.391.10- ----/IBBL_ black/nera
cod.391.00- ----/IKBL_ white/bianca
cod.391.10- ----/IKBL_ black/nera
cod.391.00- ----/IEBL_ white/bianca
cod.391.10- ----/IEBL_ black/nera
cod.391.00- ----/IDKBL_ white/bianca
cod.391.10- ----/IDKBL_ black/nera
cod. 391.00/ITCBL_ COM fabric/tessuto cliente
cod. 391.10/ITCBL_ COM fabric/tessuto cliente

DKK - kr

5.495
5.495
5.195
5.195
5.195
5.195
6.495
6.495
4.895
4.895

Felt Glides / Tappi in feltro

Fabric required
Fabbisogno di tessuto
1 pcs: Lin Mtrs 0,90 (h1,40)

COM fabric min. order
10pcs each code
Tessuto cliente 10 ordine
min. 10pz per codice

Min. order 4pcs
each code
Ordine min 4pz
per codice

CHOPPY SLEEK BP



Techno-polymer upholstered chair, 4 polymer-steel co-injected legs structure.

Seduta in tecnopolimero rivestita, struttura 4 gambe in co-iniezione metallo-polimero.

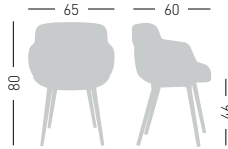
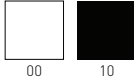

NA not assembled / non assemblato



0,24 m³ - 11 kg.
55x63x65,5cm.
1 pcs [carton]

Frame Finishing & Codes / Finiture Telai e Codici

cod.391.00- ----/IBBP00 white/bianca
cod.391.10- ----/IBBP10 black/nera
cod.391.00- ----/IKBP00 white/bianca
cod.391.10- ----/IKBP10 black/nera
cod.391.00- ----/IEBP00 white/bianca
cod.391.10- ----/IEBP10 black/nera
cod.391.00- ----/IDKBP00 white/bianca
cod.391.10- ----/IDKBP10 black/nera
cod. 391.00/ITCBP00 COM fabric/tessuto cliente
cod. 391.10/ITCBP10 COM fabric/tessuto cliente

DKK - kr

5.395
5.395
5.095
5.095
5.095
5.095
6.395
4.795
4.795

Fabric required
Fabbisogno di tessuto
1 pcs: Lin Mtrs 0,90 (h1,40)

COM fabric min. order
10pcs each code
Tessuto cliente TC ordine
min. 10pz per codice

Min. order 4pcs
each code
Ordine min 4pz
per codice

CHOPPY SLEEK U



Techno-polymer upholstered chair, swivel on 4-blade, with glides.

Seduta in tecnopolimero rivestita, girevole su basamento a 4 razze su piedini.

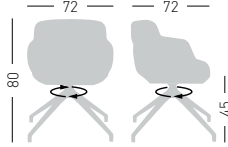
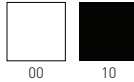

NA not assembled / non assemblato



0,36 m³ - 14 kg.
60x56x51cm
1 pcs [carton]

Frame Finishing & Codes / Finiture Telai e Codici

cod.391.00- ----/IBUB white/bianca
cod.391.10- ----/IBUN black/nera
cod.391.00- ----/IKUB white/bianca
cod.391.10- ----/IKUN black/nera
cod.391.00- ----/IEUB white/bianca
cod.391.10- ----/IEUN black/nera
cod.391.00- ----/IDKUB white/bianca
cod.391.10- ----/IDKUN black/nera
cod. 391.00/ITCUB COM fabric/tessuto cliente
cod. 391.10/ITCUM COM fabric/tessuto cliente

DKK - kr

5.995
5.995
5.695
5.695
5.695
5.695
6.895
6.895
5.395
5.395

Felt Glides / Tappi in feltro
Fabric required
Fabbisogno di tessuto
1 pcs: Lin Mtrs 0,90 (h1,40)

COM fabric min. order
10pcs each code
Tessuto cliente TC ordine
min. 10pz per codice

Min. order 4pcs
each code
Ordine min 4pz
per codice

CHOPPY SLEEK UR



Techno-polymer upholstered chair, swivel on 4-blade, with castors.

Seduta in tecnopolimero rivestita, girevole su basamento a 4 razze su ruote.

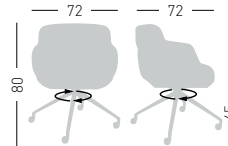
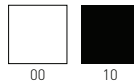

NA not assembled / non assemblato



0,36 m³ - 14,5 kg.
60x56x51cm
1 pcs [carton]

Frame Finishing & Codes / Finiture Telai e Codici

cod.391.00- ----/IBURB white/bianca
cod.391.10- ----/IBURN black/nera
cod.391.00- ----/IKURB white/bianca
cod.391.10- ----/IKURN black/nera
cod.391.00- ----/IEURB white/bianca
cod.391.10- ----/IEURN black/nera
cod.391.00- ----/IDKURB white/bianca
cod.391.10- ----/IDKURN black/nera
cod. 391.00/ITCURB COM fabric/tessuto cliente
cod. 391.10/ITCURN COM fabric/tessuto cliente

DKK - kr

6.095
6.095
5.795
5.795
5.795
5.795
6.995
6.995
5.495
5.495

Fabric required
Fabbisogno di tessuto
1 pcs: Lin Mtrs 0,90 (h1,40)

COM fabric min. order
10pcs each code
Tessuto cliente TC ordine
min. 10pz per codice

Min. order 4pcs
each code
Ordine min 4pz
per codice

CHOPPY SLEEK PL



Techno-polymer upholstered chair, 4-legged wooden swivel base with solid Oak spokes reinforced with inner steel structure.

Seduta in tecnopolimero rivestita, base girevole con quattro razze in rovere massello, rinforzate con struttura interna in acciaio.

Oak Essence / Essenza Rovere

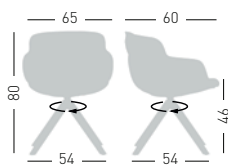

A assembled / assemblato



0,46 m³ - 10,5 kg.
71x71x91cm.
1 pc [carton]

Frame Finishing & Codes / Finiture Telai e Codici

cod. 391.00- ___/IBPLRN white/bianca
cod. 391.10- ___/IBPLRN black/nera
cod. 391.00- ___/IKPLRN white/bianca
cod. 391.10- ___/IKPLRN black/nera
cod. 391.00- ___/IEPLRN white/bianca
cod. 391.10- ___/IEPLRN black/nera
cod. 391.00- ___/IDKPLRN white/bianca
cod. 391.10- ___/IDKPLRN black/nera
cod. 391.00/ITCPLRN COM fabric/tessuto cliente
cod. 391.10/ITCPLRN COM fabric/tessuto cliente

DKK - kr

6.695
6.695
6.395
6.395
6.395
6.395
7.095
7.095
6.095
6.095

Fabric required
Fabbisogno di tessuto
4 pcs: Lin Mtrs 1,3 (h1,40)

COM fabric min. order
10pcs each code
Tessuto cliente TC ordine
min. 10pz per codice

Min. order 4pcs
each code
Ordine min 4pz
per codice

Clipperton



Available colors / Colori disponibili

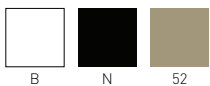

Frame / Telaio

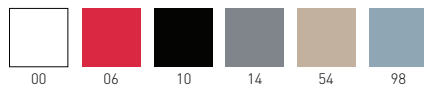

Shell / Scocca

CLIPPERTON



4-legged stackable techno-polymer chair.
Seduta impilabile in tecnopolimero.

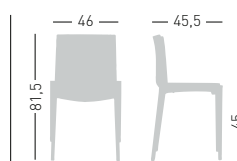

stackable / impilabile (6pcs)

A assembled / assemblato



0,36 m³ - 21,10 kg.
58x64x98cm.
4 pcs [carton]

Frame Finishing & Codes / Finiture Telai e Codici

cod.230.--/TPB white frame/telaio bianco
cod.230.--/TPN black frame/telaio nero
cod.230.--/TP52 turtledove frame/telaio tortora

DKK - kr

995
995
995

CLIPPERTON B



4-legged stackable techno-polymer chair with armrests.
Seduta impilabile in tecnopolimero con braccioli.

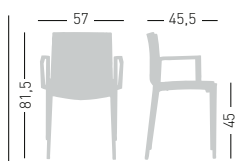

stackable / impilabile (6pcs)

A assembled / assemblato



0,36 m³ - 23,50 kg.
58x64x98cm.
4 pcs [carton]

Frame Finishing & Codes / Finiture Telai e Codici

cod.231.--/TPB white frame/telaio bianco
cod.231.--/TPN black frame/telaio nero
cod.231.--/TP52 turtledove frame/telaio tortora

DKK - kr

1.095
1.095
1.095

DRESS CLIPPERTON UPHOLSTERED IMBOTTITE

Available fabric / Tessuti disponibili
Aurea eco-leather / Ecopelle aurea **E** (4pcs min.)
King fabric / Tessuto King **K** (4pcs min.)
Blazer fabric / Tessuto Blazer **B** (4pcs min.)
Kvadrat fabrics / Tessuti Kvadrat **DK** (4pcs min.)
COM fabric / Tessuto cliente **TC** (10pcs min.)

DRESS CLIPPERTON



Techno-polymer upholstered chair.
Seduta in tecnopolimero rivestita.

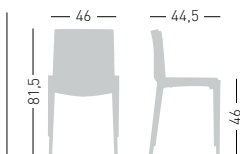

A assembled / assemblato



0,36 m³ - 12,10 kg.
58x64x98cm.
2 pcs [carton]

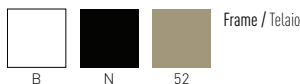

Frame Finishing & Codes / Finiture Telai e Codici

cod.230.--/IKTP--
cod.230.--/IETP--
cod.230.--/IBTP--
cod.230.--/IDKTP--
cod.230.--/ITCTP--

DKK - kr

2.395
2.395
2.595
2.895
2.395

Fabric required
Fabbisogno di tessuto
1 pcs: Lin Mtrs 0,90 (h1,40)

COM fabric min. order
10pcs each code
Tessuto cliente TC ordine
min. 10pz per codice

Min. order 4pcs
each code
Ordine min 4pz
per codice

DRESS CLIPPERTON B



Techno-polymer upholstered
chair with armrests.
Seduta in tecnopolimero rivestita
con braccioli.

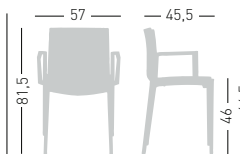

A assembled / assemblato



0,36 m³ - 13,30 kg.
58x64x98cm.
2 pcs [carton]

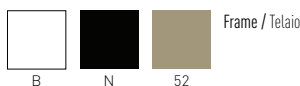

Frame Finishing & Codes / Finiture Telai e Codici

cod.231.--/IKTP--
cod.231.--/IETP--
cod.231.--/IBTP--
cod.231.--/IDKTP--
cod.231.--/ITCTP--

DKK - kr

2.495
2.495
2.695
2.995
2.495

Fabric required
Fabbisogno di tessuto
1 pcs: Lin Mtrs 0,90 (h1,40)

COM fabric min. order
10pcs each code
Tessuto cliente TC ordine
min. 10pz per codice

Min. order 4pcs
each code
Ordine min 4pz
per codice

Clipperton Blend



Available colors / Colori disponibili

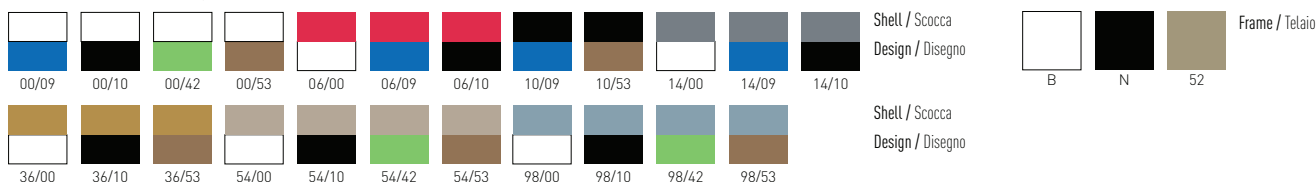

CLIPPERTON BLEND



4-legged stackable techno-polymer chair.
Seduta impilabile in tecnopolimero.

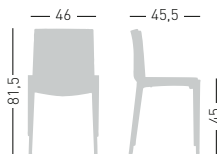

stackable / impilabile (6pcs)
A assembled / assemblato



0,36 m³ - 21,10 kg.
58x64x98cm.
4 pcs [carton]

Frame Finishing & Codes / Finiture Telai e Codici

cod.230. __-__ /TP--

DKK - kr

1.795

Min. order 20pcs
each code
Ordine min 20pz
per codice

CLIPPERTON BLEND B



4-legged stackable techno-polymer chair with armrests.
Seduta impilabile in tecnopolimero con braccioli.

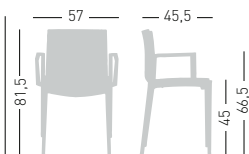

stackable / impilabile (6pcs)
A assembled / assemblato



0,36 m³ - 23,50 kg.
58x64x98cm.
4 pcs [carton]

Frame Finishing & Codes / Finiture Telai e Codici

cod.231. __-__ /TP--

DKK - kr

1.895

Min. order 20pcs
each code
Ordine min 20pz
per codice

Colorfive



Available colors / Colori disponibili

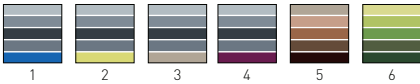

COLORFIVE NA



Chromed, black or white painted 4-Legged metal frame, techno-polymer multicolor shell.
Struttura in metallo 4 gambe, cromata, verniciata nera o bianca, scocca in tecnopolimero multicolore.



only for painted frames
solo per telai verniciati

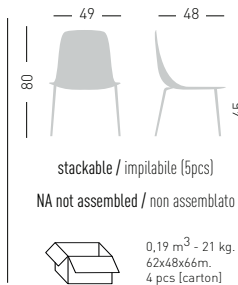

Frame Finishing & Codes / Finiture Telai e Codici

cod.135.--/NA chromed/cromata
cod.135.--/NAB white painted/verniciato bianco
cod.135.--/NAN black painted/verniciato nero

DKK - kr

1.795
1.895
1.895

COLORFIVE TB



Chromed or white painted 4-Legged metal frame with armrests, techno-polymer multicolor shell.
Struttura in metallo 4 gambe con braccioli, cromata o verniciata bianca, scocca in tecnopolimero multicolore.



only for painted frames
solo per telai verniciati

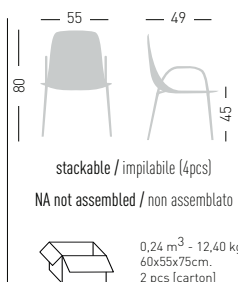

Frame Finishing & Codes / Finiture Telai e Codici

cod.135.--/TB chromed/cromata
cod.135.--/TBB white painted/verniciato bianco

DKK - kr

2.195
2.395

COLORFIVE TC



Chromed or painted wire steel metal frame, techno-polymer multicolor shell.
Struttura a traliccio in filo, cromata o verniciata, scocca in tecnopolimero multicolore.



only for painted frames
solo per telai verniciati

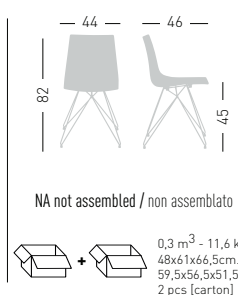

Frame Finishing & Codes / Finiture Telai e Codici

cod.135.--/TC chromed/cromata
cod.135.--/TCB white painted/verniciato bianco
cod.135.--/TCN black painted/verniciato nero

DKK - kr

2.195
2.295
2.295

COLORFIVE TP



White techno-polymer 4-Legged frame, techno-polymer multicolor shell.
Struttura in tecnopolimero 4 gambe bianca, scocca in tecnopolimero multicolore.

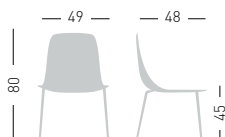

stackable / impilabile (4pcs)
NA not assembled / non assemblato



0,24 m³ - 22 kg.
55x65,5x63cm.
4 pcs [carton]

Frame Finishing & Codes / Finiture Telai e Codici

cod.135.--/TPB white painted/verniciato bianco

DKK - kr

2.095

COLORFIVE S



Chromed, black or white painted wire steel sled frame, techno-polymer multicolor shell.
Struttura a slitta in filo, cromata, verniciata nera o bianca, scocca in tecnopolimero multicolore.



only for paintend frames
solo per telai verniciati

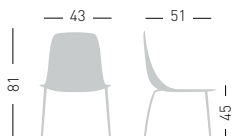

stackable / impilabile (6pcs)
NA not assembled / non assemblato



0,19 m³ - 25 kg.
49x69x68cm.
4 pcs [carton]

Frame Finishing & Codes / Finiture Telai e Codici

cod.135.--/S chromed/cromata

cod.135.--/SB white painted/verniciato bianco

cod.135.--/SN black painted/verniciato nero

DKK - kr

1.795

1.895

1.895

COLORFIVE ST



Chromed or painted sled steel frame, techno-polymer multicolor shell.
Struttura a slitta, cromata o verniciata, scocca in tecnopolimero multicolore.



only for paintend frames
solo per telai verniciati

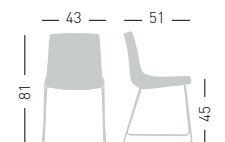

stackable / impilabile (6pcs)
NA not assembled / non assemblato



0,24 m³ - 23,60 kg.
66x55x63cm.
4 pcs [carton]

Frame Finishing & Codes / Finiture Telai e Codici

cod.135.--/ST chromed/cromata

cod.135.--/STB white painted/verniciato bianco

cod.135.--/STN black painted/verniciato nero

DKK - kr

1.895

1.995

1.995

COLORFIVE 5R



Swivel on polished aluminum base with castors, height adjustable, techno-polymer multicolor shell.
Girevole su basamento in alluminio pulito con ruote, regolabile in altezza, scocca in tecnopolimero multicolore.

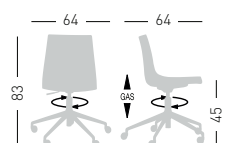

NA not assembled / non assemblato



0,24 m³ - 17 kg.
55x65,5x63cm.
2 pcs [carton]

Frame Finishing & Codes / Finiture Telai e Codici

cod.135.--/5R polished/lucida

DKK - kr

2.895

COLORFIVE L



Swivel on 4-spur polished aluminum base, techno-polymer multicolor shell.
Girevole su basamento 4 razze in alluminio pulito, scocca in tecnopolimero multicolore.

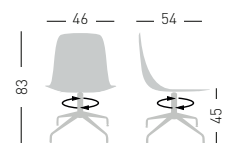

NA not assembled / non assemblato



0,24 m³ - 15 kg.
55x65,5x63cm.
2 pcs [carton]

Frame Finishing & Codes / Finiture Telai e Codici

cod.135.--/L polished/lucida

DKK - kr

2.895

Felt Glides / Tappi in feltro

COLORFIVE
CONNECTING SYSTEM
GANCIO CONNESSIONE



Set linking glides for in-line disposal.
Set piedini con agganci per disporre le sedute in linea.



Inside chairs boxes
Nella scatola delle sedie.

Assembled / assemblato

Frame Finishing & Codes / Finiture Telai e Codici

cod.1012

available for models: S
disponibile per versioni: S

DKK - kr

125

COLORFIVE
CHAIRS TROLLEY
CARRELLO PER SEDIE



Trolley for chairs, chromed metal structure.
Carrello porta sedie, struttura in metallo cromato.



0,3 m³ - 10kg
63x75x58cm.
1 pcs [carton]

Frame Finishing & Codes / Finiture Telai e Codici

cod.2000/A

available for models: S
disponibile per versioni: S

stackable on trolley 18 pcs
impilabili su carrello 18 pcs

max height with 18 chairs 178 cm
altezza carrello con 18 sedie 178 cm

DKK - kr

2.075

COLORFIVE
CHAIRS TROLLEY
CARRELLO PER SEDIE



Painted grey adjustable Dolly, for 4 legged chairs.
Carrello per sedie 4 gambe, regolabile, verniciato grigio.

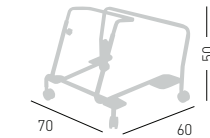

0,3 m³ - 8kg
62x72x51cm.
1 pcs [carton]

Frame Finishing & Codes / Finiture Telai e Codici

cod.2001/A

available for models: NA
disponibile per versioni: NA

DKK - kr

2.275

COLORFIVE
UPHOLSTERED
IMBOTTITE

Available coverings / Finiture disponibili
Aurea eco-leather / Ecopelle aurea **E** (4pcs min.)
King fabric / Tessuto King **K** (4pcs min.)
Blazer fabric / Tessuto Blazer **B** (4pcs min.)
COM fabric / Tessuto cliente **TC** (10pcs min.)

COLORFIVE
WRAP NA
UPHOLSTERED



Techno-polymer upholstered shell, chromed or painted metal frame.
Scocca in tecnopolimero rivestita, telaio in metallo cromato o verniciato.

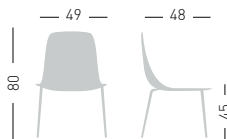

NA not assembled / non assemblato



0,24 m³ - 14,4 kg.
55x65,5x63cm.
2 pcs [carton]

Frame Finishing & Codes / Finiture Telai e Codici

cod.176.--/IENA chromed/cromata

cod.176.--/IKNA chromed/cromata

cod.176.--/IBNA chromed/cromata

cod.176/ITCNA chromed/cromata

cod.176.--/IENAB white painted/verniciato bianco

cod.176.--/IBNAB white painted/verniciato bianco

cod.176.--/IKNAB white painted/verniciato bianco

cod.176/ITCNAB white painted/verniciato bianco

cod.176.--/IENAN black painted/verniciato nero

cod.176.--/IKNAN black painted/verniciato nero

cod.176.--/IBNAN black painted/verniciato nero

cod.176/ITCNAN black painted/verniciato nero

Fabric required
Fabbisogno di tessuto
1 pcs: Lin Mtrs 1,0 (h1,40)

COM fabric min. order
10pcs each code
Tessuto cliente TC ordine
min. 10pz per codice

Min. order 4pcs
each code
Ordine min 4pz
per codice

DKK - kr

2.295

2.295

2.395

1.995

2.395

2.395

2.495

2.195

2.395

2.395

2.495

2.195

**COLORFIVE
WRAP TB
UPHOLSTERED**



Techno-polymer upholstered shell, chromed or painted metal frame with arms.

Scocca in tecnopolimero rivestita, telaio in metallo cromato o verniciato con braccioli.

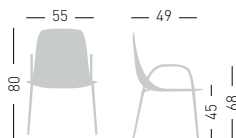

NA not assembled / non assemblato



0,24 m³ - 12,40 kg.
60x55x75cm.
2 pcs [carton]

Frame Finishing & Codes / Finiture Telai e Codici

cod.176.--/IETB chromed/cromata
cod.176.--/IKTB chromed/cromata
cod.176.--/IBTB chromed/cromata
cod.176./ITCTB chromed/cromata
cod.176.--/IETBB white painted/verniciato bianco
cod.176.--/IKTBB white painted/verniciato bianco
cod.176.--/IBTBB white painted/verniciato bianco
cod.176./ITCTBB white painted/verniciato bianco

DKK - kr

2.395
2.395
2.495
2.195
2.595
2.595
2.695
2.395

Fabric required
Fabbisogno di tessuto
1 pcs: Lin Mtrs 1,0 (h1,40)

COM fabric min. order
10pcs each code
Tessuto cliente TC ordine
min. 10pz per codice

Min. order 4pcs
each code
Ordine min 4pz
per codice

**COLORFIVE
WRAP TC
UPHOLSTERED**



Techno-polymer upholstered shell, chromed or painted metal frame.

Scocca in tecnopolimero rivestita, telaio in metallo cromato o verniciato.

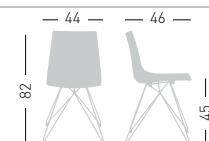

NA not assembled / non assemblato

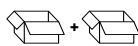

0,3 m³ - 13,4 kg.
48x61x66,5cm.
59,5x56,5x51,5cm.
2 pcs [carton]

Frame Finishing & Codes / Finiture Telai e Codici

cod.176.--/IETC chromed/cromata
cod.176.--/IKTC chromed/cromata
cod.176.--/IBTC chromed/cromata
cod.176./ITCTC chromed/cromata
cod.176.--/IETCB white painted/verniciato bianco
cod.176.--/IKTCB white painted/verniciato bianco
cod.176.--/IBTCB white painted/verniciato bianco
cod.176./ITCTCB white painted/verniciato bianco
cod.176.--/IETCN black painted/verniciato nero
cod.176.--/IKTCN black painted/verniciato nero
cod.176.--/IBTCN black painted/verniciato nero
cod.176./ITCTCN black painted/verniciato nero

DKK - kr

2.395
2.395
2.595
2.195
2.595
2.595
2.695
2.295
2.595
2.595
2.695
2.295

Fabric required
Fabbisogno di tessuto
1 pcs: Lin Mtrs 1,0 (h1,40)

COM fabric min. order
10pcs each code
Tessuto cliente TC ordine
min. 10pz per codice

Min. order 4pcs
each code
Ordine min 4pz
per codice

**COLORFIVE
WRAP TP
UPHOLSTERED**



Techno-polymer upholstered shell, techno-polymer painted frame.

Scocca in tecnopolimero rivestita, telaio in tecnopolimero verniciato.

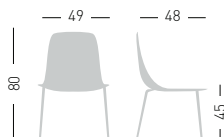

stackable / impilabile (4pcs)

NA not assembled / non assemblato



0,24 m³ - 13 kg.
55x65,5x63cm.
2 pcs [carton]

Frame Finishing & Codes / Finiture Telai e Codici

cod.176.--/IETPB white painted/verniciato bianco
cod.176.--/IKTPB white painted/verniciato bianco
cod.176.--/IBTPB white painted/verniciato bianco
cod.176./ITCTPB white painted/verniciato bianco

DKK - kr

2.495
2.495
2.595
2.195

Fabric required
Fabbisogno di tessuto
1 pcs: Lin Mtrs 1,0 (h1,40)

COM fabric min. order
10pcs each code
Tessuto cliente TC ordine
min. 10pz per codice

Min. order 4pcs
each code
Ordine min 4pz
per codice

**COLORFIVE
WRAP S
UPHOLSTERED**



Techno-polymer upholstered shell, chromed or painted metal frame.

Scocca in tecnopolimero rivestita, telaio in metallo cromato o verniciato



NA not assembled / non assemblato



0,24 m³ - 14 kg.
49x69x68cm.
2 pcs [carton]

Frame Finishing & Codes / Finiture Telai e Codici

cod.176.--/IES chromed/cromata
cod.176.--/IKS chromed/cromata
cod.176.--/IBS chromed/cromata
cod.176./ITCS chromed/cromata
cod.176.--/IESB white painted/verniciato bianco
cod.176.--/IKSB white painted/verniciato bianco
cod.176.--/IBSB white painted/verniciato bianco
cod.176./ITCSB white painted/verniciato bianco
cod.176.--/IESN black painted/verniciato nero
cod.176.--/IKSN black painted/verniciato nero
cod.176.--/IBSN black painted/verniciato nero
cod.176./ITCSN black painted/verniciato nero

DKK - kr

2.695
2.695
2.795
2.395
2.795
2.795
2.895
2.595
2.795
2.795
2.895
2.595

Fabric required
Fabbisogno di tessuto
1 pcs: Lin Mtrs 1,0 (h1,40)

COM fabric min. order
10pcs each code
Tessuto cliente TC ordine
min. 10pz per codice

Min. order 4pcs
each code
Ordine min 4pz
per codice

**COLORFIVE
WRAP ST
UPHOLSTERED**



Techno-polymer upholstered shell, chromed or painted metal frame. Scocca in tecnopolimero rivestita, telaio in metallo cromato o verniciato.

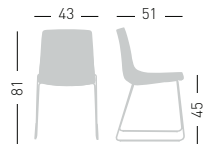

NA not assembled / non assemblato



0,24 m³ - 13,2 kg.
66x55x63cm.
2 pcs [carton]

Frame Finishing & Codes / Finiture Telai e Codici

cod.176.--/IEST chromed/cromata
cod.176.--/IKST chromed/cromata
cod.176.--/IBST chromed/cromata
cod.176/ITCST chromed/cromata
cod.176.--/IESTB white painted/verniciato bianco
cod.176.--/IKSTB white painted/verniciato bianco
cod.176.--/IBSTB white painted/verniciato bianco
cod.176/ITCSTB white painted/verniciato bianco
cod.176.--/IESTN black painted/verniciato nero
cod.176.--/IKSTN black painted/verniciato nero
cod.176.--/IBSTN black painted/verniciato nero
cod.176/ITCSTN black painted/verniciato nero

DKK - kr

2.295
2.295
2.395
2.095
2.495
2.495
2.595
2.195
2.495
2.495
2.595
2.195

Fabric required
 Fabbisogno di tessuto
 1 pcs: Lin Mtrs 1,0 (h1,40)

COM fabric min. order
 10pcs each code
 Tessuto cliente TC ordine
 min. 10pz per codice

Min. order 4pcs
 each code
 Ordine min 4pz
 per codice

**COLORFIVE
WRAP 5R
UPHOLSTERED**



Techno-polymer upholstered shell, polished aluminum base with castors. Scocca in tecnopolimero rivestita, base in alluminio pulito con ruote.

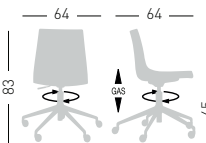

NA not assembled / non assemblato



0,24 m³ - 18 kg.
 55x65,5x63cm.
 2 pcs [carton]

Frame Finishing & Codes / Finiture Telai e Codici

cod.176.--/IESR polished/lucida
cod.176.--/IK5R polished/lucida
cod.176.--/IB5R polished/lucida
cod.176/ITC5R polished/lucida

DKK - kr

3.095
3.095
3.195
2.895

Fabric required
 Fabbisogno di tessuto
 1 pcs: Lin Mtrs 1,0 (h1,40)

COM fabric min. order
 10pcs each code
 Tessuto cliente TC ordine
 min. 10pz per codice

Min. order 4pcs
 each code
 Ordine min 4pz
 per codice

**COLORFIVE
WRAP L
UPHOLSTERED**



Techno-polymer upholstered shell, polished aluminum base. Scocca in tecnopolimero rivestita, base in alluminio pulito.

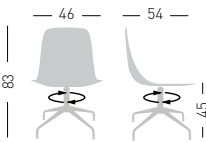

NA not assembled / non assemblato



0,24 m³ - 16 kg.
 55x65,5x63cm.
 2 pcs [carton]

Frame Finishing & Codes / Finiture Telai e Codici

cod.176.--/IEL polished/lucida
cod.176.--/IKL polished/lucida
cod.176.--/IBL polished/lucida
cod.176/ITCL polished/lucida

DKK - kr

3.095
3.095
3.195
2.895

Felt Glides / Tappi in feltro

Fabric required
 Fabbisogno di tessuto
 1 pcs: Lin Mtrs 1,0 (h1,40)

COM fabric min. order
 10pcs each code
 Tessuto cliente TC ordine
 min. 10pz per codice

Min. order 4pcs
 each code
 Ordine min 4pz
 per codice

Compact

A cosa serve una grande profondità di campo
se non c'è un'adeguata profondità di sentimento?

William Eugene Smith



Available colors / Colori disponibili

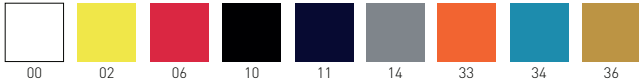

IGN Versions follows UNI 9177 certification in terms of
Fire Resistance, Fire Reaction Class 2
Versioni IGN prodotto Omologato con Classe di Reazione al
fuoco 2, UNI 9177



COMPACT



Aluminum and techno-polymer
folding chair.
Seduta pieghevole con struttura
in alluminio e tecnopolimero.

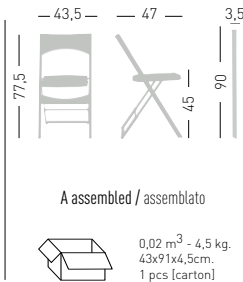

Frame Finishing & Codes / Finiture Telai e Codici

cod.29.--/A

DKK - kr

795

cod.29.--/IGN fire retardant / ignifuga

995

fire retardand minimum 300 pcs
ignifuga minimo 300 pz

COMPACT TROLLEY/CARRELLO

Trolley for Compact chair 7 pieces / Carrello sedia Compact 7 pezzi **cod. 2006/A**
Trolley for Compact chair 14 pieces / Carrello sedia Compact 14 pezzi **cod. 2007/A**



A assembled / assemblato



COMPACT WALL HOOK/GANCIO A MURO

Wall hook 2 fold. chairs / Gancio a muro per 2 sedie pieghevoli **cod. 1060**
Wall hook 4 fold. chairs / Gancio a muro per 4 sedie pieghevoli **cod. 1061**

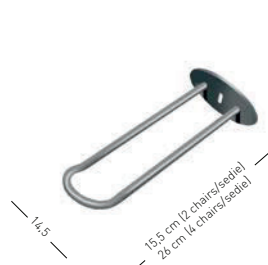

A assembled / assemblato



cod.2006/A
cod.2007/A
cod.1060
cod.1061

DKK - kr

1.475
3.475
450
450

COMPACT UNDERSEAT COVER COPERTINA SOTTOSEDILE



Compact under seat cover, to be
assembled, black color.
Copertina sotto sedile Compact, da
assemblare, colore nero.



0,02 m³ - 5 kg.
40x40x10cm.
10 pcs [carton]

NA not assembled / non assemblato

Frame Finishing & Codes / Finiture Telai e Codici

cod.333.10 black / nera

DKK - kr

100

Other colors minimum order 300pcs x color
Altri colori ordine minimo 300pz per colore



Frame / Struttura telaio

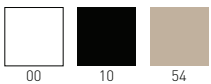

Compactop Color / Colore Piano Compactop

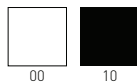

Suitable for outdoor purpose with GR-SX-MG finishes
Adatto all'uso per esterno con finiture GR-SX-MG

Available fabric / Tessuti disponibili
 Prograden fabric / Tessuto Prograden **GR**
 King fabric / Tessuto King **K**
 Silvertex Fabric / Tessuto Silvertex **SX**
 Aurea eco-leather / Ecopelle Aurea **E**
 Maglia fabric / Tessuto Maglia **MG**
 Kvadrat fabrics / Tessuti Kvadrat **DK**
 COM fabric / Tessuto cliente **TC** (10pcs min.)

BASE AND SEAT KIT



Basement with all necessary legs, caps, screws and upholstered cushion, Quick Dry Foam.
 Basamento con tutti i necessari piedini, tappi e viti, sedile tappezzato e schiuma Quick Dry.



NA not assembled / non assemblato



0,1 m³ - 6,1 kg.
55x55x31cm.
1 pcs [carton]

Frame Finishing & Codes / Finiture Telai e Codici

cod. 214.__(IGRTP_
 cod. 214.__(IKTP_
 cod. 214.__(ISXTP_
 cod. 214.__(IETP_
 cod. 214.__(IMGTP_
 cod. 214.__(IDKTP_
 cod. 214.__(ITCTP_

DKK - kr

1.595
1.695
1.795
1.695
1.795
2.395
1.495

Fabric required
 Fabbisogno di tessuto
 1 pcs: Lin Mtrs 1,0 (h1,40)

COM fabric min. order
 10pcs each code
 Tessuto cliente TC ordine
 min. 10pzs per codice

BACKREST/SCHIENALE



Backrest support with upholstered cushion, Quick Dry Foam.
 Supporto Schienale con Cuscino tappez., schiuma Quick Dry.

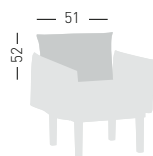

NA not assembled / non assemblato



0,07 m³ - 2,5 kg.
61x60x20cm.
1 pcs [carton]

Frame Finishing & Codes / Finiture Telai e Codici

cod. 210.__(GR)
 cod. 210.__(K)
 cod. 210.__(SX)
 cod. 210.__(E)
 cod. 210.__(MG)
 cod. 210.__(DK)
 cod. 210.__(TC)

DKK - kr

995
995
1.095
995
1.095
1.595
895

Fabric required
 Fabbisogno di tessuto
 1 pcs: Lin Mtrs 1,0 (h1,40)

COM fabric min. order
 10pcs each code
 Tessuto cliente TC ordine
 min. 10pzs per codice

**SINGLE ARMREST/
BRACCIOLO
SINGOLO**

Armrest support with upholstered cushion, Quick Dry Foam.
Supporto Bracciolo con Cuscino tappez., schiuma Quick Dry.

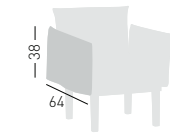

NA not assembled / non assemblato



0,06 m³ - 2 kg.
66x43x20cm.
1 pcs (carton)

Frame Finishing & Codes / Finiture Telai e Codici

cod. 212.__(GR)
cod. 212.__(K)
cod. 212.__(SX)
cod. 212.__(E)
cod. 212.__(MG)
cod. 212.__(DK)
cod. 212.__(TC)

DKK - kr

795
895
895
895
895
1.295
695

Fabric required
Fabbisogno di tessuto
1 pcs: Lin Mtrs 1,0 (h1,40)

COM fabric min. order
10pcs each code
Tessuto cliente TC ordine
min. 10pz per codice

TABLE/TAVOLINO

Table, with Compactop.
Tavolino con Compactop.

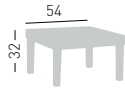

NA not assembled / non assemblato



0,1 m³ - 8 kg.
60x60x30cm.
1 pcs (carton)

Frame Finishing & Codes / Finiture Telai e Codici

cod. TCONC028.__-_/H32

DKK - kr

1.595

EXAMPLES / ESEMPI:

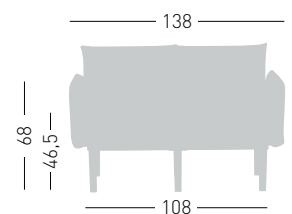
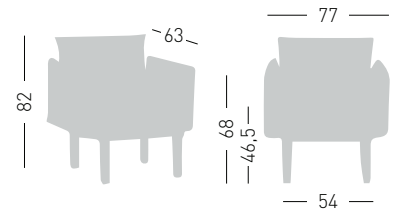

Cucaracha



Products follows UNI 9175 -UNI 9175/FA, in terms of Fire Resistance, Fire Reation Class 11M
 Prodotto Omologato dal Ministero dell'Interno , secondo la UNI 9175 -UNI 9175/FA, con classe di Reazione al fuoco 11M



Available fabric / Tessuti disponibili
 King fabric / Tessuto King **K** (2pcs min.)
 Blazer fabric / Tessuto Blazer **B** (2pcs min.)
 Kvadrat fabrics / Tessuti Kvadrat **DK** (2pcs min.)
 COM fabric / Tessuto cliente **TC** (10pcs min.)

CUCARACHA LB



Swivel in 4-blade black painted aluminum base, tilt mechanism, upholstered low back shell.
 Girevole su basamento 4 razze in alluminio nero, meccanismo oscillante, scocca schienale basso rivestita.

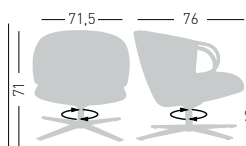

NA not assembled / non assemblato



0,71 m³ - 29 kg.
 80x90x95cm.
 1 pc (carton)

Frame Finishing & Codes / Finiture Telai e Codici

cod.395. __/IBLN
 cod.395. __/IKLN
 cod.395. __/IDKLN
 cod.395. __/ITCLN

DKK - kr

10.695
9.995
11.395
9.195

Fabric required
 Fabbisogno di tessuto
 1 pcs: Lin Mtrs 1,8 (h1,40)

COM fabric min. order
 10pcs each code
 Tessuto cliente TC ordine
 min. 10pz per codice

Min. order 2pcs
 each code
 Ordine min 2pz
 per codice

CUCARACHA HB



Swivel in 4-blade black painted aluminum base, tilt mechanism, upholstered high back shell.
 Girevole su basamento 4 razze in alluminio nero, meccanismo oscillante, scocca schienale alto rivestita.

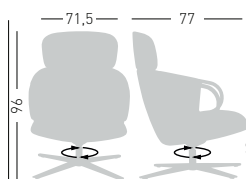

NA not assembled / non assemblato



0,71 m³ - 31 kg.
 80x90x95cm.
 1 pc (carton)

Frame Finishing & Codes / Finiture Telai e Codici

cod.394. __/IBLN
 cod.394. __/IKLN
 cod.394. __/IDKLN
 cod.394. __/ITCLN

DKK - kr

11.395
10.795
12.095
10.395

Twin color upholstery details available on request
 Dettagli tappezzeria bi-colore disponibili su richiesta

Fabric required
 Fabbisogno di tessuto
 1 pcs: Lin Mtrs 1,8 (h1,40)

COM fabric min. order
 10pcs each code
 Tessuto cliente TC ordine
 min. 10pz per codice

Min. order 2pcs
 each code
 Ordine min 2pz
 per codice

CUCARACHA LB BL



Upholstered PU-Flex low back Shell,
4-legged beech wooden frame.
Scocca schienale basso in PU-Flex
rivestita, struttura in legno di faggio 4
gambe..



Price + DKK 150

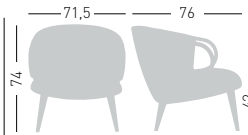

NA not assembled / non assemblato



0,71 m³ - 29 kg.
80x90x95cm.
1 pc (carton)

Frame Finishing & Codes / Finiture Telai e Codici

cod.395._/IBBL_
cod.395._/IKBL_
cod.395._/IDKBL_
cod.395._/ITCBL_

Felt Glides / Tappi in feltro

DKK - kr

10.895
10.195
11.595
9.395

Fabric required
Fabbisogno di tessuto
1 pcs: Lin Mtrs 1,8 (h1,40)

COM fabric min. order
10pcs each code
Tessuto cliente TC ordine
min. 10pz per codice

Min. order 2pcs
each code
Ordine min 2pz
per codice

CUCARACHA HB BL



Upholstered High Back PU-Flex Shell,
4-legged beech wooden frame.
Scocca schienale alto in PU-Flex rivestita,
struttura in legno di faggio 4 gambe.

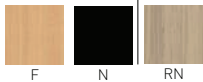

Price + DKK 150

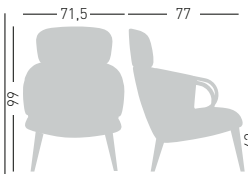

NA not assembled / non assemblato



0,71 m³ - 31 kg.
80x90x95cm.
1 pc (carton)

Frame Finishing & Codes / Finiture Telai e Codici

cod.394._/IBBL_
cod.394._/IKBL_
cod.394._/IDKBL_
cod.394._/ITCBL_

Felt Glides / Tappi in feltro

DKK - kr

11.695
10.995
12.295
10.595

Twin color upholstery details available on request
Dettagli tappezzeria bi-colore disponibili su richiesta

Fabric required
Fabbisogno di tessuto
1 pcs: Lin Mtrs 1,8 (h1,40)

COM fabric min. order
10pcs each code
Tessuto cliente TC ordine
min. 10pz per codice

Min. order 2pcs
each code
Ordine min 2pz
per codice

CUCARACHA TABLET / TAVOLETTA



Swivel and 360° rotating
compactop tablet.
Tavoletta in Compactop
girevole e rotante a 360°.

Available for model:
Cucaracha LB - Cucaracha HB
Disponibile per versioni:
Cucaracha LB - Cucaracha HB

NA not assembled / non assemblato



0,25 m³ - 9 kg.
60x54x76cm.
1 pc (carton)

Frame Finishing & Codes / Finiture Telai e Codici

cod.1210.10

DKK - kr

3.695

Cucaracha Slim



Products follows UNI 9175 -UNI 9175/FA, in terms of Fire Resistance, Fire Reation Class 1M
 Prodotto Omologato dal Ministero dell'Interno , secondo la UNI 9175 -UNI 9175/FA, con classe di Reazione al fuoco 1M



Available fabric / Tessuti disponibili
 King fabric / Tessuto King **K** (4pcs min.)
 Blazer fabric / Tessuto Blazer **B** (4pcs min.)
 Kvadrat fabrics / Tessuti Kvadrat **DK** (4pcs min.)
 COM fabric / Tessuto cliente **TC** (10pcs min.)

CUCARACHA SLIM BL



Upholstered PU-Flex Shell, 4-legged beech wooden frame.
 Scocca in PU-Flex rivestita, struttura in legno di faggio 4 gambe.

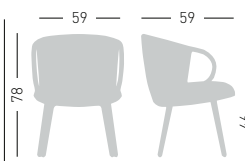
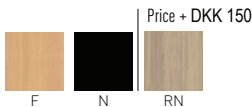

A assembled / assemblato



0,30 m³ - 13 kg.
 60x54x92cm.
 1 pc [carton]

Frame Finishing & Codes / Finiture Telai e Codici

cod.393._/IBBL_
 cod.393._/IKBL_
 cod.393._/IDKBL_
 cod.393/ITCBL_

DKK - kr

6.095
5.495
6.895
4.995

Felt Glides / Tappi in feltro

Fabric required
 Fabbisogno di tessuto
 1 pcs: Lin Mtrs 1,4 (h1,40)

COM fabric min. order
 10pcs each code
 Tessuto cliente TC ordine
 min. 10pz per codice

Min. order 4pcs
 each code
 Ordine min 4pz
 per codice

CUCARACHA SLIM U



Upholstered PU-Flex Shell, swivel on 4-blade painted or polished aluminum base.Tilt mechanism.

Scocca un PU-Flex rivestita, girevole su basamento verniciato o lucido in alluminio 4 razze. Meccanismo oscillante.

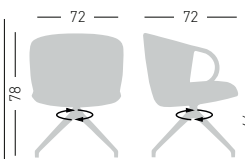

NA not assembled / non assemblato



0,30 m³ - 14 kg.
 60x54x92cm.
 1 pc [carton]

Frame Finishing & Codes / Finiture Telai e Codici

cod.393._/IBUN black/nera
 cod.393._/IKUN black/nera
 cod.393._/IDKUN black/nera
 cod.393/ITCUN black/nera
 cod.393._/IBUL polished/lucida
 cod.393._/IKUL polished/lucida
 cod.393._/IDKUL polished/lucida
 cod.393/ITCUL polished/lucida

DKK - kr

6.295
5.595
7.095
5.195
6.395
5.795
7.195
4.895

Felt Glides / Tappi in feltro

Fabric required
 Fabbisogno di tessuto
 1 pcs: Lin Mtrs 1,4 (h1,40)

COM fabric min. order
 10pcs each code
 Tessuto cliente TC ordine
 min. 10pz per codice

Min. order 4pcs
 each code
 Ordine min 4pz
 per codice

Dame



Available Shell Color / Colori disponibili Scocca

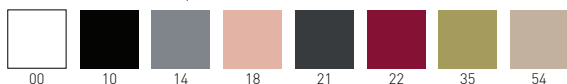

Available coverings / Finiture disponibili
 King fabric / Tessuto King **K** (4pcs min.)
 Blazer fabric / Tessuto Blazer **B** (4pcs min.)
 Superb Trevira Velvet / Velluto Superb Trevira **S** (4pcs min.)
 Kvadrat fabrics / Tessuti Kvadrat **DK** (4pcs min.)
 Silvertex Fabric / Tessuto Silvertex **SX** (4pcs min.)
 Aurea eco-leather / Ecopelle Aurea **E** (4pcs min.)
 Maglia fabric / Tessuto Maglia **MG** (4pcs min.)
 COM fabric / Tessuto Cliente **TC** (10pcs min.)

DAME NA



Chromed or painted 4-Legged metal frame, techno-polymer shell and upholstered cushion.
 Struttura in metallo 4 gambe, cromata o verniciata, scocca in tecnopolimero con cuscino tappezzato.

Unless otherwise specified, frame and shell colors are combined.
 Se non diversamente specificato, i colori della struttura e della scocca sono abbinati.

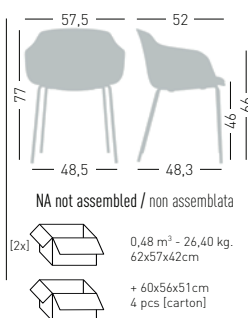

Available Painted Frame Colors / Colori disponibili Telaio Verniciato

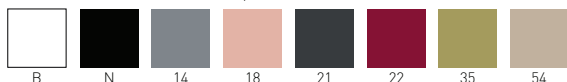

Suitable for outdoor purpose with SX-E-MG finishes
 Adatto all'uso per esterni con finiture SX-E-MG

Frame Finishing & Codes / Finiture Telai e Codici

cod. 266.__(K)/NA chromed/cromata	DKK - kr	2.295
cod. 266.__(B)/NA chromed/cromata		2.295
cod. 266.__(S)/NA chromed/cromata		2.295
cod. 266.__(DK)/NA chromed/cromata		2.395
cod. 266.__(SX)/NA chromed/cromata		2.295
cod. 266.__(E)/NA chromed/cromata		2.295
cod. 266.__(MG)/NA chromed/cromata		2.295
cod. 266.__(TC)/NA chromed/cromata		2.195
cod. 266.__(K)/NA painted/verniciato		2.395
cod. 266.__(B)/NA painted/verniciato		2.495
cod. 266.__(S)/NA painted/verniciato		2.495
cod. 266.__(DK)/NA painted/verniciato		2.495
cod. 266.__(SX)/NA painted/verniciato		2.495
cod. 266.__(E)/NA painted/verniciato		2.395
cod. 266.__(MG)/NA painted/verniciato		2.495
cod. 266.__(TC)/NA painted/verniciato		2.395

Fabric required
 Fabbisogno di tessuto
 4 pcs: Lin Mtrs 1,0 (h1,40)

COM fabric min. order
 10pcs each code
 Tessuto cliente TC ordine
 min. 10pz per codice

Min. order 4pcs
 each code
 Ordine min 4pz
 per codice

DAME BP



4 polymer-steel co-injected legs structure, techno-polymer shell and upholstered cushion.

Struttura 4 gambe in co-iniezione metallo-polimero, scocca in tecnopolimero e cuscino tappezzato.

Unless otherwise specified, frame and shell colors are combined.

Se non diversamente specificato, i colori della struttura e della scocca sono abbinati.

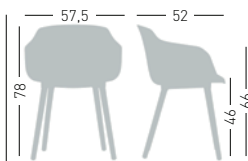

NA not assembled / non assemblata



0,18 m³ - 14,60 kg.
60x56x51 cm.
2 pcs [carton]

Frame Finishing & Codes / Finiture Telai e Codici

cod. 266. __ - **[K]** /BP__
cod. 266. __ - **[B]** /BP__
cod. 266. __ - **[S]** /BP__
cod. 266. __ - **[DK]** /BP__
cod. 266. __ - **[SX]** /BP__
cod. 266. __ - **[E]** /BP__
cod. 266. __ - **[MG]** /BP__
cod. 266. __ - **TC** /BP__

DKK - kr

2.795

2.795

2.795

2.895

2.795

2.795

2.795

2.695

Fabric required
Fabbisogno di tessuto
4 pcs: Lin Mtrs 1,0 (h1,40)

COM fabric min. order
10pcs each code
Tessuto cliente TC ordine
min. 10pz per codice

Min. order 4pcs
each code
Ordine min 4pz
per codice

Available Legs Color / Colori disponibili Gambe

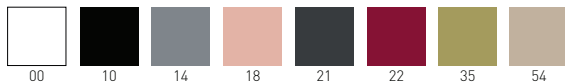

Suitable for outdoor purpose with SX-E-MG finishes
Adatto all'uso per esterni con finiture SX-E-MG

DAME CTL



Chromed or Painted cantilevered metal frame, techno-polymer shell and upholstered cushion.

Struttura in metallo cantilever, cromata o verniciata, scocca in tecnopolimero e cuscino tappezzato.

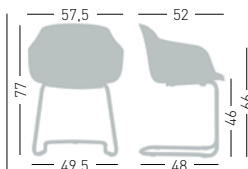

NA not assembled / non assemblata



0,54 m³ - 27,20 kg.
62x57x42cm



+ 66x55x63cm
4 pcs [carton]

Frame Finishing & Codes / Finiture Telai e Codici

cod. 266. __ - **[K]** /CTL chromed/cromata
cod. 266. __ - **[B]** /CTL chromed/cromata
cod. 266. __ - **[S]** /CTL chromed/cromata
cod. 266. __ - **[DK]** /CTL chromed/cromata
cod. 266. __ - **[SX]** /CTL chromed/cromata
cod. 266. __ - **[E]** /CTL chromed/cromata
cod. 266. __ - **[MG]** /CTL chromed/cromata
cod. 266. __ - **TC** /CTL chromed/cromata

DKK - kr

2.495

2.495

2.495

2.595

2.495

2.495

2.495

2.395

cod. 266. __ - **[K]** /CTLN black painted/verniciato nero
cod. 266. __ - **[B]** /CTLN black painted/verniciato nero
cod. 266. __ - **[S]** /CTLN black painted/verniciato nero
cod. 266. __ - **[DK]** /CTLN black painted/verniciato nero
cod. 266. __ - **[SX]** /CTLN black painted/verniciato nero
cod. 266. __ - **[E]** /CTLN black painted/verniciato nero
cod. 266. __ - **[MG]** /CTLN black painted/verniciato nero
cod. 266. __ - **TC** /CTLN black painted/verniciato nero

2.595

2.595

2.595

2.695

2.595

2.595

2.595

2.495

Fabric required
Fabbisogno di tessuto
4 pcs: Lin Mtrs 1,0 (h1,40)

COM fabric min. order
10pcs each code
Tessuto cliente TC ordine
min. 10pz per codice

Min. order 4pcs
each code
Ordine min 4pz
per codice

DAME ST



Chromed or painted sled steel frame, techno-polymer shell and upholstered cushion.

Struttura a slitta, cromata o verniciata, scocca in tecnopolimero e cuscino tappezzato.

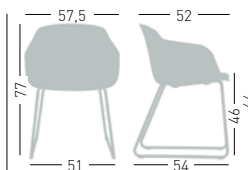

NA not assembled / non assemblata



0,54 m³ - 27,20 kg.
62x57x42cm
+ 66x55x63cm
4 pcs [carton]



Frame Finishing & Codes / Finiture Telai e Codici

cod. 266. __ - **[K]** /ST chromed/cromata
cod. 266. __ - **[B]** /ST chromed/cromata
cod. 266. __ - **[S]** /ST chromed/cromata
cod. 266. __ - **[DK]** /ST chromed/cromata
cod. 266. __ - **[SX]** /ST chromed/cromata
cod. 266. __ - **[E]** /ST chromed/cromata
cod. 266. __ - **[MG]** /ST chromed/cromata
cod. 266. __ - **TC** /ST chromed/cromata

DKK - kr

2.395

2.495

2.495

2.495

2.395

2.395

2.395

2.395

cod. 266. __ - **[K]** /STN black painted/verniciato nero
cod. 266. __ - **[B]** /STN black painted/verniciato nero
cod. 266. __ - **[S]** /STN black painted/verniciato nero
cod. 266. __ - **[DK]** /STN black painted/verniciato nero
cod. 266. __ - **[SX]** /STN black painted/verniciato nero
cod. 266. __ - **[E]** /STN black painted/verniciato nero
cod. 266. __ - **[MG]** /STN black painted/verniciato nero
cod. 266. __ - **TC** /STN black painted/verniciato nero

2.495

2.595

2.595

2.595

2.495

2.495

2.495

2.495

Fabric required
Fabbisogno di tessuto
4 pcs: Lin Mtrs 1,0 (h1,40)

COM fabric min. order
10pcs each code
Tessuto cliente TC ordine
min. 10pz per codice

Min. order 4pcs
each code
Ordine min 4pz
per codice

DAME PL



4-legged wooden swivel base with solid Oak spokes reinforced with inner steel structure, techno-polymer shell and upholstered cushion.
Base girevole con quattro razze in rovere rinforzate con struttura in acciaio interna, scocca in tecnopolimero e cuscino tappezzato.

CATAS
TESTATO - TESTED

Oak Essence / Essenza Rovere



RN

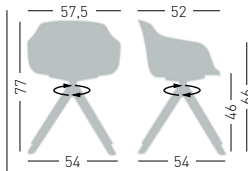

A assembled / assemblata



0,30 m³ - 9 kg.
54x60x92 cm.
1 pcs [carton]

Frame Finishing & Codes / Finiture Telai e Codici

cod. 266.__(K)/PLRN Oak/Rovere
cod. 266.__(B)/PLRN Oak/Rovere
cod. 266.__(S)/PLRN Oak/Rovere
cod. 266.__(DK)/PLRN Oak/Rovere
cod. 266.__(SX)/PLRN Oak/Rovere
cod. 266.__(E)/PLRN Oak/Rovere
cod. 266.__(MG)/PLRN Oak/Rovere
cod. 266.__(TC)/PLRN Oak/Rovere

DKK - kr

3.995
4.095
4.095
4.195
4.895
3.995
4.095
3.995

Fabric required
Fabbisogno di tessuto
4 pcs: Lin Mtrs 1,0 (h1,40)

COM fabric min. order
10pcs each code
Tessuto cliente TC ordine
min. 10pz per codice

Min. order 4pcs
each code
Ordine min 4pz
per codice

DAME BL



4-Legged wooden beach frame, techno-polymer shell and upholstered cushion.
Struttura in legno di faggio 4 gambe, scocca in tecnopolimero e cuscino tappezzato.

Price + DKK 150



F

RN

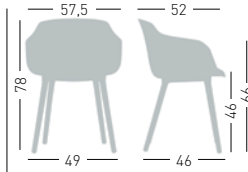

NA not assembled / non assemblata



0,48 m³ - 31 kg.
62x57x42cm



+ 60x56x51cm
4 pcs [carton]

Frame Finishing & Codes / Finiture Telai e Codici

cod. 266.__(K)/BL_
cod. 266.__(B)/BL_
cod. 266.__(S)/BL_
cod. 266.__(DK)/BL_
cod. 266.__(SX)/BL_
cod. 266.__(E)/BL_
cod. 266.__(MG)/BL_
cod. 266.__(TC)/BL_

DKK - kr

3.095
3.095
3.095
3.195
3.095
3.095
3.095
2.995

Felt Glides / Tappi in feltro

Fabric required
Fabbisogno di tessuto
4 pcs: Lin Mtrs 1,0 (h1,40)

COM fabric min. order
10pcs each code
Tessuto cliente TC ordine
min. 10pz per codice

Min. order 4pcs
each code
Ordine min 4pz
per codice

DAME U



Swivel in 4-blade aluminum painted base, with glides, techno-polymer shell and upholstered cushion.
Girevole su basamento verniciato a 4 razze su piedini, scocca in tecnopolimero e cuscino tappezzato.

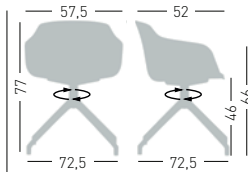

NA not assembled / non assemblata



0,33 m³ - 15 kg.
62x57x42cm



+ 60x56x51cm
2 pcs [carton]

Frame Finishing & Codes / Finiture Telai e Codici

cod. 266.__(K)/UB white painted/verniciato bianco
cod. 266.__(B)/UB white painted/verniciato bianco
cod. 266.__(S)/UB white painted/verniciato bianco
cod. 266.__(DK)/UB white painted/verniciato bianco
cod. 266.__(SX)/UB white painted/verniciato bianco
cod. 266.__(E)/UB white painted/verniciato bianco
cod. 266.__(MG)/UB white painted/verniciato bianco
cod. 266.__(TC)/UB white painted/verniciato bianco

DKK - kr

3.295
3.395
3.395
3.395
3.295
3.295
3.295
3.195

cod. 266.__(K)/UN black painted/verniciato nero
cod. 266.__(B)/UN black painted/verniciato nero
cod. 266.__(S)/UN black painted/verniciato nero
cod. 266.__(DK)/UN black painted/verniciato nero
cod. 266.__(SX)/UN black painted/verniciato nero
cod. 266.__(E)/UN black painted/verniciato nero
cod. 266.__(MG)/UN black painted/verniciato nero
cod. 266.__(TC)/UN black painted/verniciato nero

3.295
3.395
3.395
3.395
3.295
3.295
3.295
3.195

Felt Glides / Tappi in feltro

Fabric required
Fabbisogno di tessuto
4 pcs: Lin Mtrs 1,0 (h1,40)

COM fabric min. order
10pcs each code
Tessuto cliente TC ordine
min. 10pz per codice

Min. order 4pcs
each code
Ordine min 4pz
per codice

DAME UR



Swivel on 4-blade aluminum painted base, with castors, techno-polymer shell and upholstered cushion.

Girevole su basamento verniciato in alluminio 4 razze su ruote, scocca in tecnopolimero e cuscino tappezzato.

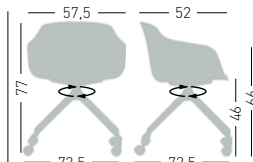

NA not assembled / non assemblata



0,30 m² - 15,2 kg.
62x57x42cm
+ 42x57x42cm
2 pcs [carton]

Frame Finishing & Codes / Finiture Telai e Codici

cod. 266. __ - **(K)**_URB white painted/verniciato bianco
 cod. 266. __ - **(B)**_URB white painted/verniciato bianco
 cod. 266. __ - **(S)**_URB white painted/verniciato bianco
 cod. 266. __ - **(DK)**_URB white painted/verniciato bianco
 cod. 266. __ - **(SX)**_URB white painted/verniciato bianco
 cod. 266. __ - **(E)**_URB white painted/verniciato bianco
 cod. 266. __ - **(MG)**_URB white painted/verniciato bianco
 cod. 266. __ - **TC**_URB white painted/verniciato bianco

DKK - kr

3.395
3.395
3.395
3.495
3.395
3.395
3.395
3.295

cod. 266. __ - **(K)**_URN black painted/verniciato nero
 cod. 266. __ - **(B)**_URN black painted/verniciato nero
 cod. 266. __ - **(S)**_URN black painted/verniciato nero
 cod. 266. __ - **(DK)**_URN black painted/verniciato nero
 cod. 266. __ - **(SX)**_URN black painted/verniciato nero
 cod. 266. __ - **(E)**_URN black painted/verniciato nero
 cod. 266. __ - **(MG)**_URN black painted/verniciato nero
 cod. 266. __ - **TC**_URN black painted/verniciato nero

3.395
3.395
3.395
3.495
3.395
3.395
3.395
3.295

Fabric required
 Fabbisogno di tessuto
 4 pcs: Lin Mtrs 1,0 (h1,40)

COM fabric min. order
 10pcs each code
 Tessuto cliente TC ordine
 min. 10pz per codice

Min. order 4pcs
 each code
 Ordine min 4pz
 per codice

DAME R



Swivel on chromed base, techno-polymer shell and upholstered cushion.

Girevole su basamento in acciaio cromato, scocca in tecnopolimero e cuscino tappezzato.

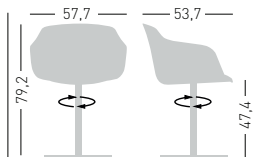

NA not assembled / non assemblata



0,14 m² - 15,5 kg.
61x56x41,5cm
1 pc [carton]

Frame Finishing & Codes / Finiture Telai e Codici

cod. 266. __ - **(K)**_R chromed base/base cromata
 cod. 266. __ - **(B)**_R chromed base/base cromata
 cod. 266. __ - **(S)**_R chromed base/base cromata
 cod. 266. __ - **(DK)**_R chromed base/base cromata
 cod. 266. __ - **(SX)**_R chromed base/base cromata
 cod. 266. __ - **(E)**_R chromed base/base cromata
 cod. 266. __ - **(MG)**_R chromed base/base cromata
 cod. 266. __ - **TC**_R chromed base/base cromata

DKK - kr

3.195
3.295
3.295
3.295
3.295
3.195
3.295
3.195

Fabric required
 Fabbisogno di tessuto
 4 pcs: Lin Mtrs 1,0 (h1,40)

COM fabric min. order
 10pcs each code
 Tessuto cliente TC ordine
 min. 10pz per codice

Min. order 4pcs
 each code
 Ordine min 4pz
 per codice

DAME UPHOLSTERED IMBOTTITE

Available coverings / Finiture disponibili
 King fabric / Tessuto King **K** (4pcs min.)
 Blazer fabric / Tessuto Blazer **B** (4pcs min.)
 Superb Trevira Velvet / Velluto Superb Trevira **S** (4pcs min.)
 Kvadrat fabrics / Tessuti Kvadrat **DK** (4pcs min.)
 Aurea eco-leather / Ecopelle Aurea **E** (4pcs min.)
 Leather / Pelle **P** (4pcs min.)
 COM fabric / Tessuto Cliente **TC** (10pcs min.)

DRESS DAME NA

Chromed or painted 4-Legged metal frame, padded and upholstered shell. Struttura in metallo 4 gambe, cromata o verniciata, scocca imbottita e rivestita.

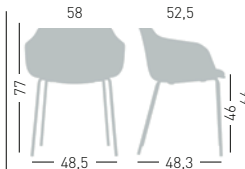

NA not assembled / non assemblata

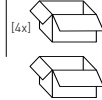

0,78 m³ - 33,20 kg.
 62x57x42cm
 + 60x56x51cm
 4 pcs [carton]

Frame Finishing & Codes / Finiture Telai e Codici

cod. 266. / **IKNA** chromed/cromata
 cod. 266. / **IBNA** chromed/cromata
 cod. 266. / **ISNA** chromed/cromata
 cod. 266. / **IDKNA** chromed/cromata
 cod. 266. / **IENA** chromed/cromata
 cod. 266. / **IPNA** chromed/cromata
 cod. 266 / **ITCNA** chromed/cromata

cod. 266. / **IKNA** painted/verniciato
 cod. 266. / **IBNA** painted/verniciato
 cod. 266. / **ISNA** painted/verniciato
 cod. 266. / **IDKNA** painted/verniciato
 cod. 266. / **IENA** painted/verniciato
 cod. 266. / **IPNA** painted/verniciato
 cod. 266 / **ITCNA** painted/verniciato

DKK - kr

3.895
4.195
4.195
4.795
3.895
4.795
3.695

Fabric required
 Fabbisogno di tessuto
 1 pc: Lin Mtrs 1,8 (h1,40)

COM fabric min. order
 10pcs each code
 Tessuto cliente TC ordine
 min. 10pz per codice

Min. order 4pcs
 each code
 Ordine min 4pz
 per codice

Available Painted Frame Colors / Colori disponibili Telaio Verniciato

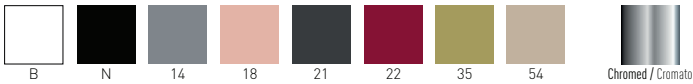

DRESS DAME BP

4 polymer-steel co-injected legs structure, padded and upholstered shell. Struttura 4 gambe in co-iniezione metallo-polimero, scocca imbottita e rivestita.

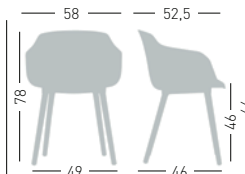

NA not assembled / non assemblata



0,15 m³ - 9 kg.
 62x57x42 cm.
 1 pc [carton]

Frame Finishing & Codes / Finiture Telai e Codici

cod. 266. / **IKBP**
 cod. 266. / **IBBP**
 cod. 266. / **ISBP**
 cod. 266. / **IDKBP**
 cod. 266. / **IEBP**
 cod. 266. / **IPBP**
 cod. 266 / **ITCBP**

DKK - kr

4.395
4.695
4.695
5.095
4.395
5.095
4.195

Fabric required
 Fabbisogno di tessuto
 1 pc: Lin Mtrs 1,8 (h1,40)

COM fabric min. order
 10pcs each code
 Tessuto cliente TC ordine
 min. 10pz per codice

Min. order 4pcs
 each code
 Ordine min 4pz
 per codice

Available Legs Color / Colori disponibili Gambe

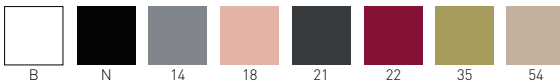

DRESS DAME CTL



Chromed or Painted cantilevered metal frame, padded and upholstered shell.
Struttura in metallo cantilever, cromata o verniciata, scocca imbottita e rivestita.

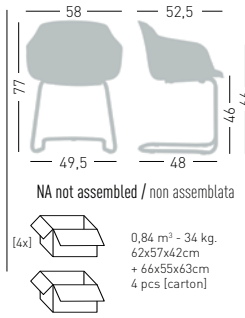

Frame Finishing & Codes / Finiture Telai e Codici

cod. 266. __/IKCTL chromed/cromata
cod. 266. __/IBCTL chromed/cromata
cod. 266. __/ISCTL chromed/cromata
cod. 266. __/IDKCTL chromed/cromata
cod. 266. __/IECTL chromed/cromata
cod. 266. __/IPCTL chromed/cromata
cod. 266./ITCCTL chromed/cromata

DKK - kr

4.095

4.395

4.395

4.795

4.095

4.795

3.895

cod. 266. __/IKCTLN black painted/verniciato nero
cod. 266. __/IBCTLN black painted/verniciato nero
cod. 266. __/ISCTLN black painted/verniciato nero
cod. 266. __/IDKCTLN black painted/verniciato nero
cod. 266. __/IECTLN black painted/verniciato nero
cod. 266. __/IPCTLN black painted/verniciato nero
cod. 266./ITCCTLN black painted/verniciato nero

4.195

4.495

4.495

4.995

4.195

4.995

4.095

Fabric required
Fabbisogno di tessuto
1 pc: Lin Mtrs 1,8 (h1,40)

COM fabric min. order
10pcs each code
Tessuto cliente TC ordine
min. 10pz per codice

Min. order 4pcs
each code
Ordine min 4pz
per codice

DRESS DAME ST



Chromed or painted sled steel frame, padded and upholstered shell.
Struttura a slitta, cromata o verniciata, scocca imbottita e rivestita.

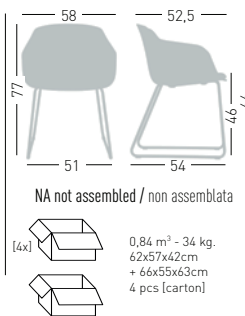

Frame Finishing & Codes / Finiture Telai e Codici

cod. 266. __/IKST chromed/cromata
cod. 266. __/IBST chromed/cromata
cod. 266. __/ISST chromed/cromata
cod. 266. __/IDKST chromed/cromata
cod. 266. __/IEST chromed/cromata
cod. 266. __/IPST chromed/cromata
cod. 266./ITCST chromed/cromata

DKK - kr

4.095

4.395

4.395

4.795

4.095

4.795

3.895

cod. 266. __/IKSTN black painted/verniciato nero
cod. 266. __/IBSTN black painted/verniciato nero
cod. 266. __/ISSTN black painted/verniciato nero
cod. 266. __/IDKSTN black painted/verniciato nero
cod. 266. __/IESTN black painted/verniciato nero
cod. 266. __/IPSTN black painted/verniciato nero
cod. 266./ITCSTN black painted/verniciato nero

4.195

4.495

4.495

4.995

4.195

4.995

3.995

Fabric required
Fabbisogno di tessuto
1 pc: Lin Mtrs 1,8 (h1,40)

COM fabric min. order
10pcs each code
Tessuto cliente TC ordine
min. 10pz per codice

Min. order 4pcs
each code
Ordine min 4pz
per codice

DRESS DAME PL



4-legged wooden swivel base with solid Oak spokes reinforced with inner steel structure, padded and upholstered shell.
Base girevole con quattro razze in rovere rinforzate con struttura in acciaio interna, scocca imbottita e rivestita.

Oak Essence / Essenza Rovere



RN

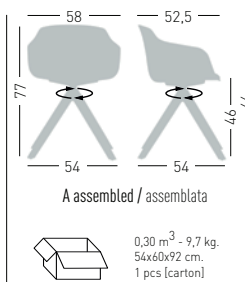

Frame Finishing & Codes / Finiture Telai e Codici

cod. 266. __/IKPLRN Oak/Rovere
cod. 266. __/IBPLRN Oak/Rovere
cod. 266. __/ISPLRN Oak/Rovere
cod. 266. __/IDKPLRN Oak/Rovere
cod. 266. __/IEPLRN Oak/Rovere
cod. 266. __/IPPLRN Oak/Rovere
cod. 266./ITCPLRN Oak/Rovere

DKK - kr

5.395

5.695

5.695

6.195

5.395

6.195

5.195

Fabric required
Fabbisogno di tessuto
1 pc: Lin Mtrs 1,8 (h1,40)

COM fabric min. order
10pcs each code
Tessuto cliente TC ordine
min. 10pz per codice

Min. order 4pcs
each code
Ordine min 4pz
per codice

DRESS DAME BL



4-Legged wooden beach frame, padded and upholstered shell.
Struttura in legno di faggio 4 gambe, scocca imbottita e rivestita.

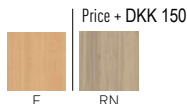

Price + DKK 150

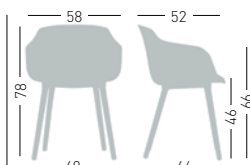

NA not assembled / non assemblata

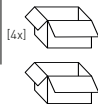

0,78 m³ - 37,80 kg.
62x57x42cm
+ 60x56x51cm
4 pcs [carton]

Frame Finishing & Codes / Finiture Telai e Codici

cod. 266.__/IKBL_
cod. 266.__/IBBL_
cod. 266.__/ISBL_
cod. 266.__/IDKBL_
cod. 266.__/IEBL_
cod. 266.__/IPBL_
cod. 266./ITCBL_

DKK - kr

4.695
4.995
4.995
5.395
4.695
5.395
4.495

Felt Glides / Tappi in feltro

Fabric required
Fabbisogno di tessuto
1 pc: Lin Mtrs 1,8 (h1,40)

COM fabric min. order
10pcs each code
Tessuto cliente TC ordine
min. 10pz per codice

Min. order 4pcs
each code
Ordine min 4pz
per codice

DRESS DAME U



Swivel in 4-blade aluminum painted base, with glides, padded and upholstered shell.

Girevole su basamento verniciato a 4 razze su piedini, scocca imbottita e rivestita.

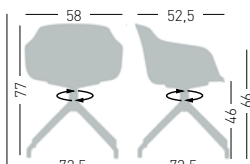

NA not assembled / non assemblata

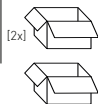

0,48 m³ - 18,4 kg.
62x57x42cm
+ 60x56x51cm
2 pcs [carton]

Frame Finishing & Codes / Finiture Telai e Codici

cod. 266.__/IKUB white painted/verniciato bianco
cod. 266.__/IBUB white painted/verniciato bianco
cod. 266.__/ISUB white painted/verniciato bianco
cod. 266.__/IDKUB white painted/verniciato bianco
cod. 266.__/IEUB white painted/verniciato bianco
cod. 266.__/IPUB white painted/verniciato bianco
cod. 266./ITCUB white painted/verniciato bianco

DKK - kr

4.895
5.195
5.195
5.695
4.895
5.695
4.695

cod. 266.__/IKUN black painted/verniciato nero
cod. 266.__/IBUN black painted/verniciato nero
cod. 266.__/ISUN black painted/verniciato nero
cod. 266.__/IDKUN black painted/verniciato nero
cod. 266.__/IEUN black painted/verniciato nero
cod. 266.__/IPUN black painted/verniciato nero
cod. 266./ITCUN black painted/verniciato nero

4.895
5.195
5.195
5.695
4.895
5.695
4.695

Felt Glides / Tappi in feltro

Fabric required
Fabbisogno di tessuto
1 pc: Lin Mtrs 1,8 (h1,40)

COM fabric min. order
10pcs each code
Tessuto cliente TC ordine
min. 10pz per codice

Min. order 4pcs
each code
Ordine min 4pz
per codice

DRESS DAME UR



Swivel on 4-blade aluminum painted base, with castors, padded and upholstered shell.

Girevole su basamento verniciato in alluminio 4 razze su ruote, scocca imbottita e rivestita.

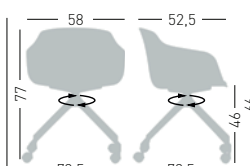

NA not assembled / non assemblata



0,45 m³ - 18,6 kg.
62x57x42 cm.
2 pcs [carton]

Frame Finishing & Codes / Finiture Telai e Codici

cod. 266.__/IKURB white painted/verniciato bianco
cod. 266.__/IBURB white painted/verniciato bianco
cod. 266.__/ISURB white painted/verniciato bianco
cod. 266.__/IDKURB white painted/verniciato bianco
cod. 266.__/IEURB white painted/verniciato bianco
cod. 266.__/IPURB white painted/verniciato bianco
cod. 266./ITCURB white painted/verniciato bianco

DKK - kr

4.995
5.295
5.295
5.695
4.995
4.795
4.795

cod. 266.__/IKURN black painted/verniciato nero
cod. 266.__/IBURN black painted/verniciato nero
cod. 266.__/ISURN black painted/verniciato nero
cod. 266.__/IDKURN black painted/verniciato nero
cod. 266.__/IEURN black painted/verniciato nero
cod. 266.__/IPURN black painted/verniciato nero
cod. 266./ITCURN black painted/verniciato nero

4.995
5.295
5.295
5.695
4.995
5.695
4.795

Fabric required
Fabbisogno di tessuto
1 pc: Lin Mtrs 1,8 (h1,40)

COM fabric min. order
10pcs each code
Tessuto cliente TC ordine
min. 10pz per codice

Min. order 4pcs
each code
Ordine min 4pz
per codice

DRESS DAME R



Swivel on chromed base, padded and upholstered shell.
Girevole su basamento in acciaio cromato, scocca imbottita e rivestita.

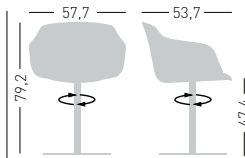

NA not assembled / non assemblata



0,14 m³ - 16 kg.
61x56x41,5cm
1 pc [carton]

Frame Finishing & Codes / Finiture Telai e Codici

cod. 266.___/IKR chromed base/base cromata
cod. 266.___/IBR chromed base/base cromata
cod. 266.___/ISR chromed base/base cromata
cod. 266.___/IDKR chromed base/base cromata
cod. 266.___/IVR chromed base/base cromata
cod. 266.___/IER chromed base/base cromata
cod. 266.___/IMGR chromed base/base cromata
cod. 266.___/ITCR chromed base/base cromata

DKK - kr

4.495
4.795
5.595
4.595
4.495
4.595
4.295

Fabric required
 Fabbisogno di tessuto
 4 pcs: Lin Mtrs 1,8 (h1,40)

COM fabric min. order
 10pcs each code
 Tessuto cliente TC ordine
 min. 10pz per codice

Min. order 4pcs
 each code
 Ordine min 4pz
 per codice

Eala



Cover available on request.
Disponibile su richiesta telo di copertura.

Frame / Struttura telaio

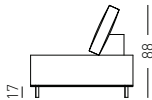

MG Maglia and FO Fortezza 93 coverings are suitable for outdoor use. In addition, MG Maglia is waterproof. I rivestimenti MG Maglia e FO Fortezza 93 sono adatti per un utilizzo Outdoor. Il rivestimento MG Maglia è inoltre impermeabile.

Available fabric / Tessuti disponibili
Fortezza 93 fabric / Tessuto Fortezza 93 **FO**
Maglia fabric / Tessuto Maglia **MG**

POUFF MODULE MODULO POUFF



High Density polyurethane foam, wooden structure supported by an aluminum and techno-polymer base, equipped with steel feet.

Poliuretano espanso ad alta densità, struttura in legno con cinghie elastiche e basamento in alluminio e tecnopolimero, dotato di piedini in acciaio.

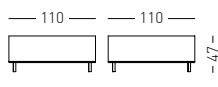

Feet to be assembled / Piedini da assemblare



0,61 m³ - 40 kg.
114x114x47cm.
1 pc [carton]

Frame Finishing & Codes / Finiture Telaio e Codici

cod.420._/IFOA_
cod.420._/IMGA_

DKK - kr

13.495
13.495

COM Fabric on request
Tessuto TC su richiesta

SMALL MODULE MODULO SMALL



High Density polyurethane foam, wooden structure supported by an aluminum and techno-polymer base, equipped with steel feet.

Poliuretano espanso ad alta densità, struttura in legno con cinghie elastiche e basamento in alluminio e tecnopolimero, dotato di piedini in acciaio.



Feet to be assembled / Piedini da assemblare



0,90 m³ - 52 kg.
114x168x47cm.
1 pc [carton]

Frame Finishing & Codes / Finiture Telaio e Codici

cod.421._/IFOA_
cod.421._/IMGA_

DKK - kr

18.295
18.295

COM Fabric on request
Tessuto TC su richiesta

MEDIUM MODULE MODULO MEDIUM



High Density polyurethane foam, wooden structure supported by an aluminum and techno-polymer base, equipped with steel feet.

Poliuretano espanso ad alta densità, struttura in legno con cinghie elastiche e basamento in alluminio e tecnopolimero, dotato di piedini in acciaio.



Feet to be assembled / Piedini da assemblare



1,13 m² - 66 kg.
114x211x47cm.
1 pc [carton]

Frame Finishing & Codes / Finiture Telai e Codici

cod.422. __/IFOA_
cod.422. __/IMGA_

COM Fabric on request
Tessuto TC su richiesta

DKK - kr

21.695
21.695

LARGE MODULE MODULO LARGE



High Density polyurethane foam, wooden structure supported by an aluminum and techno-polymer base, equipped with steel feet.

Poliuretano espanso ad alta densità, struttura in legno con cinghie elastiche e basamento in alluminio e tecnopolimero, dotato di piedini in acciaio.

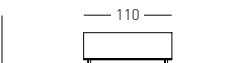

Feet to be assembled / Piedini da assemblare



1,32 m² - 75 kg.
114x211x47cm.
1 pc [carton]

Frame Finishing & Codes / Finiture Telai e Codici

cod.423. __/IFOA_
cod.423. __/IMGA_

COM Fabric on request
Tessuto TC su richiesta

DKK - kr

23.995
23.995

ARMREST BRACCIOLO



High Density polyurethane foam armrest.

Bracciolo in poliuretano espanso ad alta densità.

Available fabric.
Tessuti disponibili.

FO, MG



A assembled / assemblato



0,04 m² - 3,5 kg.
90x32x13cm.
1 pc [carton]

Frame Finishing & Codes / Finiture Telai e Codici

cod.426. __

COM Fabric on request
Tessuto TC su richiesta

Cannot be sold individually
but only combined with sofa modules
Non vendibile singolarmente
ma solo abbinato ai moduli divano

DKK - kr

2.495

BACKREST SUPPORT SUPPORTO SCHIENALE



High Density polyurethane foam with additional weight, anti-skid designed support.

Poliuretano espanso ad alta densità con zavorra, supporto progettato antiscivolo.

Available fabric.
Tessuti disponibili.

FO, MG

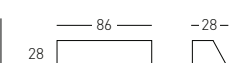

A assembled / assemblato



0,08 m² - 11 kg.
90x32x28cm.
1 pc [carton]

Frame Finishing & Codes / Finiture Telai e Codici

cod.427. __

COM Fabric on request
Tessuto TC su richiesta

Cannot be sold individually
but only combined with sofa modules
Non vendibile singolarmente
ma solo abbinato ai moduli divano

DKK - kr

4.595

CUSHION CUSCINO



Cushion in a mix of goose down and polyester fiber.
Cuscino in appoggio posizionabile in misto piuma d'oca e fibra di poliestere.

Available fabric.
Tessuti disponibili.

FO, MG

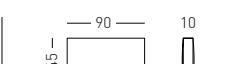

0,05 m² - 5 kg.
94x49x10cm.
1 pc [carton]

Frame Finishing & Codes / Finiture Telai e Codici

cod.428. __

COM Fabric on request
Tessuto TC su richiesta

Cannot be sold individually
but only combined with sofa modules
Non vendibile singolarmente
ma solo abbinato ai moduli divano

DKK - kr

2.695

Elodie



Available colors thermoformed back (front and back can be different)
Colori disponibili schienale termoformato (fronte e retro possono essere diversi)

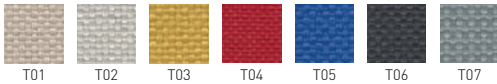

The Elodie Collection coverings can be customized with a minimum order quantity of 100pcs.
La Collezione Elodie può essere personalizzata nei rivestimenti con quantità minima ordine pari a 100pz.

Available coverings / Finiture disponibili
King L fabric / Tessuto King L **L** (4pcs min.)
King fabric / Tessuto King **K** (4pcs min.)
Blazer fabric / Tessuto Blazer **B** (4pcs min.)
Kvadrat fabrics / Tessuti Kvadrat **DK** (4pcs min.)

ELODIE TASK 05R



Swivel on 5-spur aluminium base, height adjustable, synchro mechanism weight sensitive, with arm, sound-absorbent backrest.
Girevole su basamento 5 razze in alluminio, regolabile in altezza, meccanismo sincronizzato autopesante, con braccioli, schienale fonoassorbente.

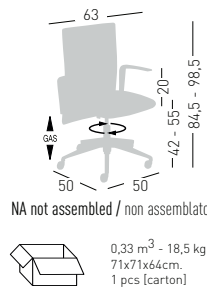

Frame Finishing & Codes / Finiture Telai e Codici

cod.810. __ /IL05RN
cod.810. __ /IL05RB
cod.810. __ /IK05RN
cod.810. __ /IK05RB
cod.810. __ /IB05RN
cod.810. __ /IB05RB
cod.810. __ /IDK05RN
cod.810. __ /IDK05RB

DKK - kr

6.595
6.595
6.595
6.595
6.795
6.795
6.795
6.795

Twin color on demand
Bicolore su richiesta

Min. order 4pcs
each code
Ordine min 4pz
per codice

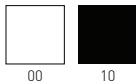

Armrests and base colors are combined
Colore dei braccioli è abbinato alla base

ELODIE MANAGER 05R



Swivel on 5-spur aluminium base, height adjustable, synchro mechanism weight sensitive, with arm, sound-absorbent backrest.
Girevole su basamento 5 razze in alluminio, regolabile in altezza, meccanismo sincronizzato autopesante, con braccioli, schienale fonoassorbente.

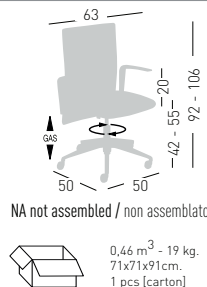

Frame Finishing & Codes / Finiture Telai e Codici

cod.820. __ /IL05RN
cod.820. __ /IL05RB
cod.820. __ /IK05RN
cod.820. __ /IK05RB
cod.820. __ /IB05RN
cod.820. __ /IB05RB
cod.820. __ /IDK05RN
cod.820. __ /IDK05RB

DKK - kr

7.695
7.695
7.695
7.695
7.895
7.895
7.895
7.895

Twin color on demand
Bicolore su richiesta

Min. order 4pcs
each code
Ordine min 4pz
per codice

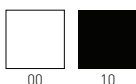

Armrests and base colors are combined
Colore dei braccioli è abbinato alla base

ELODIE EXECUTIVE O5R



Swivel on 5-spur aluminium base, height adjustable, synchro mechanism weight sensitive, with arm, sound-absorbent backrest.
Girevole su basamento 5 razze in alluminio, regolabile in altezza, meccanismo sincronizzato autopesante, con braccioli, schienale fonoassorbente.

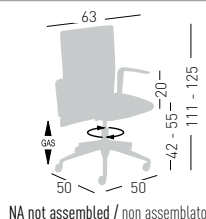

NA not assembled / non assemblato



0,46 m³ - 19 kg.
71x71x91cm.
1 pcs [carton]



Armrests and base colors are combined
Colore dei braccioli è abbinato alla base

Frame Finishing & Codes / Finiture Telai e Codici

cod.830._._/IL05RN
cod.830._._/IL05RB
cod.830._._/IK05RN
cod.830._._/IK05RB
cod.830._._/IB05RN
cod.830._._/IB05RB
cod.830._._/IDK05RN
cod.830._._/IDK05RB

DKK - kr

8.995
8.995
8.995
8.995
9.195
9.195
9.195
9.195

Twin color on demand
Bicolore su richiesta

Min. order 4pcs
each code
Ordine min 4pz
per codice

ELODIE TASK U



Swivel on 4-blade, synchro mechanism weight sensitive, sound-absorbent backrest.
Girevole su basamento 4 razze, meccanismo sincronizzato autopesante, schienale fonoassorbente.

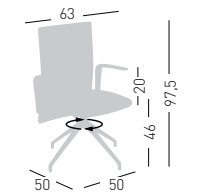

NA not assembled / non assemblato



Cod. 811
0,33 m³ - 16 kg.
71x71x64cm.
1 pcs [carton]



Cod. 810
0,33 m³ - 18,5 kg.
71x71x64cm.
1 pcs [carton]

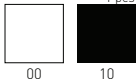

Armrests and base colors are combined
Colore dei braccioli è abbinato alla base

Frame Finishing & Codes / Finiture Telai e Codici

cod.810._._/ILU_ with armrests/con braccioli
cod.810._._/IKU_ with armrests/con braccioli
cod.810._._/IBU_ with armrests/con braccioli
cod.810._._/IDKU_ with armrests/con braccioli
cod.811._._/ILU_
cod.811._._/IKU_
cod.811._._/IBU_
cod.811._._/IDKU_

DKK - kr

6.595
6.595
6.795
6.795
6.195
6.195
6.395
6.395

Felt Glides / Tappi in feltro

Twin color on demand
Bicolore su richiesta

Min. order 4pcs
each code
Ordine min 4pz
per codice

ELODIE MANAGER U



Swivel on 4-blade, synchro mechanism weight sensitive, sound-absorbent backrest.
Girevole su basamento 4 razze, meccanismo sincronizzato autopesante, schienale fonoassorbente.

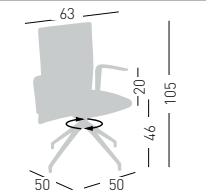

NA not assembled / non assemblato



0,46 m³ - 19 kg.
71x71x91cm.
1 pcs [carton]

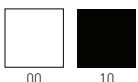

Armrests and base colors are combined
Colore dei braccioli è abbinato alla base

Frame Finishing & Codes / Finiture Telai e Codici

cod.820._._/ILUN
cod.820._._/ILUB
cod.820._._/IKUN
cod.820._._/IKUB
cod.820._._/IBUN
cod.820._._/IBUB
cod.820._._/IDKUN
cod.820._._/IDKUB

DKK - kr

7.695
7.695
7.695
7.695
7.895
7.895
7.895
7.895

Felt Glides / Tappi in feltro

Twin color on demand
Bicolore su richiesta

Min. order 4pcs
each code
Ordine min 4pz
per codice

Epica



Available colors / Colori disponibili



EPICA FIX

Fix techno-polymer chair with cushion.
Sedia fissa in tecnopolimero con cuscino imbottito.



CATAS
TESTATO - TESTED

Available fabric.
Tessuti disponibili.
B, K, E, S, DK
COM fabric / Tessuto cliente TC

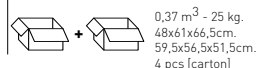
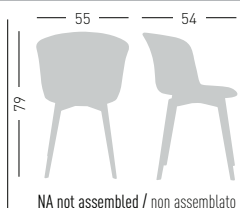

Frame Finishing & Codes / Finiture Telai e Codici

cod. 350. __ - (K)/TP __
cod. 350. __ - (E)/TP __
cod. 350. __ - (B)/TP __
cod. 350. __ - (S)/TP __
cod. 350. __ - (DK)/TP __
cod. 350. __ - TC/TP __ COM fabric/tessuto cliente

DKK - kr

1.495
1.495
1.495
1.495
1.595
1.395

Legs and shells colors can be combined
I colori delle gambe possono essere abbinati alla scocca

Fabric required
Fabbisogno di tessuto
4 pcs : Lin Mtrs 1 (h1,40)

COM fabric min. order
10pcs each code
Tessuto cliente TC ordine
min. 10pz per codice

Min. order 4pcs
each code
Ordine min 4pz
per codice

EPICA 360

Swivel techno-polymer chair with cushion.
Sedia girevole in tecnopolimero con cuscino imbottito.



Available fabric.
Tessuti disponibili.
B, K, E, S, DK
COM fabric / Tessuto cliente TC

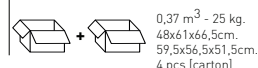
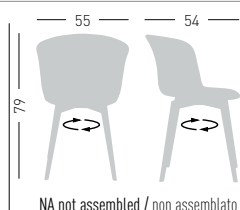

Frame Finishing & Codes / Finiture Telai e Codici

cod. 351. __ - (K)/TP __
cod. 351. __ - (E)/TP __
cod. 351. __ - (B)/TP __
cod. 351. __ - (S)/TP __
cod. 351. __ - (DK)/TP __
cod. 351. __ - TC/TP __ COM fabric/tessuto cliente

DKK - kr

1.495
1.495
1.495
1.495
1.595
1.395

Legs and shells colors can be combined
I colori delle gambe possono essere abbinati alla scocca

Fabric required
Fabbisogno di tessuto
4 pcs : Lin Mtrs 1 (h1,40)

COM fabric min. order
10pcs each code
Tessuto cliente TC ordine
min. 10pz per codice

Min. order 4pcs
each code
Ordine min 4pz
per codice

EPICA SR

Techno-polymer chair with cushion, swivel movement.
Sedia in tecnopolimero con movimento girevole, cuscino imbottito.



Available fabric.
Tessuti disponibili.
B, K, E, S, DK
COM fabric / Tessuto cliente TC

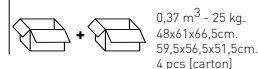
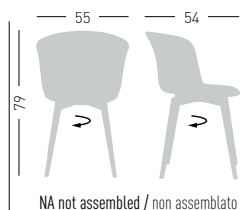

Frame Finishing & Codes / Finiture Telai e Codici

cod. 352. __ - (K)/TP __
cod. 352. __ - (E)/TP __
cod. 352. __ - (B)/TP __
cod. 352. __ - (S)/TP __
cod. 352. __ - (DK)/TP __
cod. 352. __ - TC/TP __ COM fabric/tessuto cliente

DKK - kr

1.495
1.495
1.495
1.495
1.595
1.395

Legs and shells colors can be combined
I colori delle gambe possono essere abbinati alla scocca

Fabric required
Fabbisogno di tessuto
4 pcs : Lin Mtrs 1 (h1,40)

COM fabric min. order
10pcs each code
Tessuto cliente TC ordine
min. 10pz per codice

Min. order 4pcs
each code
Ordine min 4pz
per codice

EPICA UPHOLSTERED IMBOTTITE

Available coverings / Finiture disponibili
 Blazer fabric / Tessuto Blazer **B** (4pcs min.)
 King fabric / Tessuto King **K** (4pcs min.)
 Superb Trevira Velvet / Velluto Superb Trevira **S** (4pcs min.)
 Kvadrat fabrics / Tessuti Kvadrat **DK** (4pcs min.)
 COM fabric / Tessuto cliente **TC** (10pcs min.)

DRESS EPICA FIX

Fix upholstered chair.
Sedia fissa imbottita.

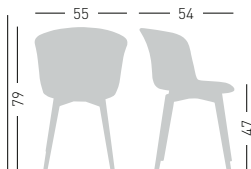

A assembled / assemblato



0,31 m³ - 7 kg.
61x55x93cm.
1 pcs [carton]

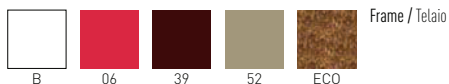

Frame Finishing & Codes / Finiture Telai e Codici

cod.350._/IBTP__
cod.350._/ISTP__
cod.350._/IKTP__
cod.350._/IDKTP__
cod.350._/ITCTP__ COM fabric/tessuto cliente

DKK - kr

3.595
3.595
3.595
4.495
3.395

Fabric required
Fabbisogno di tessuto
1 pcs : Lin Mtrs 1,5 (h1,40)

COM fabric min. order
10pcs each code
Tessuto cliente TC ordine
min. 10pz per codice

Min. order 4pcs
each code
Ordine min 4pz
per codice

DRESS EPICA 360

Swivel upholstered chair.
Sedia girevole imbottita.

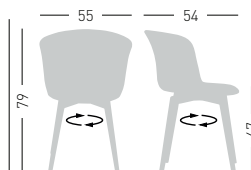

A assembled / assemblato



0,31 m³ - 7 kg.
61x55x93cm.
1 pcs [carton]

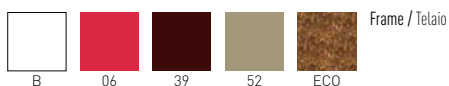

Frame Finishing & Codes / Finiture Telai e Codici

cod.351._/IBTP__
cod.351._/ISTP__
cod.351._/IKTP__
cod.351._/IDKTP__
cod.351._/ITCTP__ COM fabric/tessuto cliente

DKK - kr

3.595
3.595
3.595
4.495
3.395

Fabric required
Fabbisogno di tessuto
1 pcs : Lin Mtrs 1,5 (h1,40)

COM fabric min. order
10pcs each code
Tessuto cliente TC ordine
min. 10pz per codice

Min. order 4pcs
each code
Ordine min 4pz
per codice

DRESS EPICA SR

Upholstered chair with swivel
movement.
Seduta tappezzata con movimento
girevole.

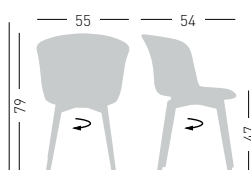

A assembled / assemblato



0,31 m³ - 7 kg.
61x55x93cm.
1 pcs [carton]

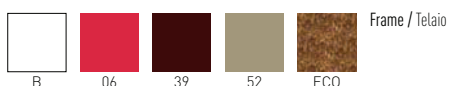

Frame Finishing & Codes / Finiture Telai e Codici

cod.352._/IBTP__
cod.352._/ISTP__
cod.352._/IKTP__
cod.352._/IDKTP__
cod.352._/ITCTP__ COM fabric/tessuto cliente

DKK - kr

3.595
3.595
3.595
4.495
3.395

Fabric required
Fabbisogno di tessuto
1 pcs : Lin Mtrs 1,5 (h1,40)

COM fabric min. order
10pcs each code
Tessuto cliente TC ordine
min. 10pz per codice

Min. order 4pcs
each code
Ordine min 4pz
per codice

Etesian



Cover available on request.
Disponibile su richiesta telo di copertura.

Frame / Struttura telaio



MG Maglia and FO Fortezza 93 coverings are suitable for outdoor use. In addition, MG Maglia is waterproof. I rivestimenti MG Maglia e FO Fortezza 93 sono adatti per un utilizzo Outdoor. Il rivestimento MG Maglia è inoltre impermeabile.

Available fabric / Tessuti disponibili
Fortezza 93 fabric / Tessuto Fortezza 93 **FO**
Maglia fabric / Tessuto Maglia **MG**

ETESIAN MODULE 1

Etesian pouf.
Pouf Etesian.

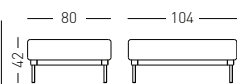

Feet to be assembled / Piedini da assemblare



0,36 m³ - 31 kg.
106x84x40 cm.
1 pc [carton]

Frame Finishing & Codes / Finiture Telai e Codici

cod. 481, __/IFOA__
cod. 481, __/IMGA__

DKK - kr

7.695
7.695

COM Fabric on request
Tessuto TC su richiesta

ETESIAN MODULE 2

Etesian armchair.
Poltrona Etesian.

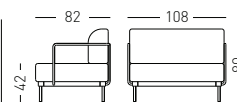

Feet to be assembled / Piedini da assemblare



0,72 m³ - 52 kg.
110x84x78 cm.
1 pc [carton]

Frame Finishing & Codes / Finiture Telai e Codici

cod. 482, __/IFOA__
cod. 482, __/IMGA__

DKK - kr

11.895
11.895

COM Fabric on request
Tessuto TC su richiesta

**ETESIAN
MODULE 3**

Etesian armchair with padded arms.
Poltrona con braccioli imbottiti Etesian.

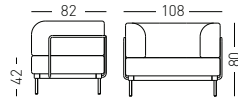

Feet to be assembled / Piedini da assemblare



0,72 m³ - 54 kg.
110x84x78 cm.
1 pc [carton]

Frame Finishing & Codes / Finiture Telai e Codici

cod. 483,___/IFOA___
cod. 483,___/IMGA___

COM Fabric on request
Tessuto TC su richiesta

DKK - kr

13.495
13.495

**ETESIAN
MODULE 4**

Etesian angular element SX.
Elemento angolare SX Etesian.

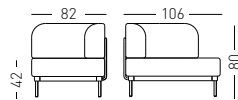

Feet to be assembled / Piedini da assemblare



0,72 m³ - 42 kg.
110x84x78 cm.
1 pc [carton]

Frame Finishing & Codes / Finiture Telai e Codici

cod. 484,___/IFOA___
cod. 484,___/IMGA___

COM Fabric on request
Tessuto TC su richiesta

DKK - kr

12.295
12.295

**ETESIAN
MODULE 5**

Etesian angular element DX.
Elemento angolare DX Etesian.

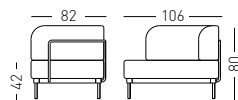

Feet to be assembled / Piedini da assemblare



0,72 m³ - 42 kg.
110x84x78 cm.
1 pc [carton]

Frame Finishing & Codes / Finiture Telai e Codici

cod. 485,___/IFOA___
cod. 485,___/IMGA___

COM Fabric on request
Tessuto TC su richiesta

DKK - kr

12.295
12.295

**ETESIAN
MODULE 6**

Etesian lounge pouf.
Lounge pouf Etesian.

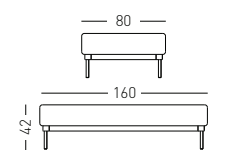

Feet to be assembled / Piedini da assemblare



0,56 m³ - 39 kg.
166x84x40 cm.
1 pc [carton]

Frame Finishing & Codes / Finiture Telai e Codici

cod. 486,___/IFOA___
cod. 486,___/IMGA___

COM Fabric on request
Tessuto TC su richiesta

DKK - kr

9.795
9.795

**ETESIAN
MODULE 7**

Etesian twin-seater sofa.
Divano a due posti Etesian.

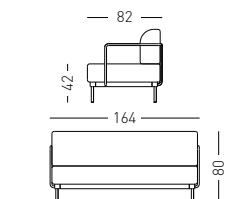

Feet to be assembled / Piedini da assemblare



1,88 m³ - 51 kg.
166x84x78 cm.
1 pc [carton]

Frame Finishing & Codes / Finiture Telai e Codici

cod. 487,___/IFOA___
cod. 487,___/IMGA___

COM Fabric on request
Tessuto TC su richiesta

DKK - kr

19.295
19.295

ETESIAN MODULE 8

Etesian twin-seater sofa
with padded arms.
Divano a due posti
con braccioli imbottiti Etesian.

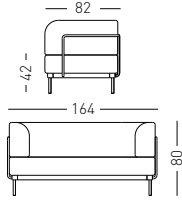

Feet to be assembled / Piedini da assemblare



1,07 m³ - 63 kg.
166x84x78 cm.
1 pc [carton]

Frame Finishing & Codes / Finiture Telai e Codici

cod. 488,___/IFOA___
cod. 488,___/IMGA___

COM Fabric on request
Tessuto TC su richiesta

DKK - kr

19.195
19.195

ETESIAN MODULE 9

Etesian lounge SX.
Lounge SX Etesian.

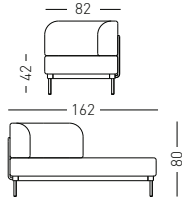

Feet to be assembled / Piedini da assemblare



1,07 m³ - 51 kg.
166x84x78 cm.
1 pc [carton]

Frame Finishing & Codes / Finiture Telai e Codici

cod. 489,___/IFOA___
cod. 489,___/IMGA___

COM Fabric on request
Tessuto TC su richiesta

DKK - kr

14.895
14.895

ETESIAN MODULE 10

Etesian lounge DX.
Lounge DX Etesian.

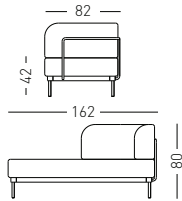

Feet to be assembled / Piedini da assemblare



1,07 m³ - 51 kg.
166x84x78 cm.
1 pc [carton]

Frame Finishing & Codes / Finiture Telai e Codici

cod. 490,___/IFOA___
cod. 490,___/IMGA___

COM Fabric on request
Tessuto TC su richiesta

DKK - kr

14.895
14.895

ETESIAN MODULE 11

Etesian lounge with long back
support.
Lounge con supporto schienale lungo
Etesian.

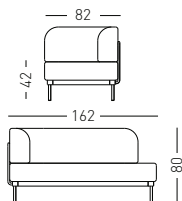

Feet to be assembled / Piedini da assemblare



1,88 m³ - 59 kg.
166x84x78 cm.
1 pc [carton]

Frame Finishing & Codes / Finiture Telai e Codici

cod. 491,___/IFOA___
cod. 491,___/IMGA___

COM Fabric on request
Tessuto TC su richiesta

DKK - kr

17.495
17.495

ETESIAN MODULE 12

Etesian large lounge.
Large lounge Etesian.

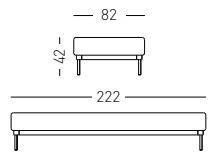

Feet to be assembled / Piedini da assemblare



0,76 m³ - 48 kg.
226x84x40 cm.
1 pc [carton]

Frame Finishing & Codes / Finiture Telai e Codici

cod. 492,___/IFOA___
cod. 492,___/IMGA___

COM Fabric on request
Tessuto TC su richiesta

DKK - kr

11.795
11.795

**ETESIAN
MODULE 13**

Etesian three-seater sofa.
Divano a tre posti Etesian.

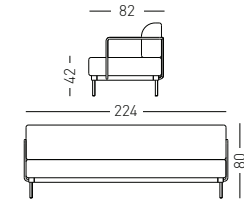

Feet to be assembled / Piedini da assemblare



1,48 m³ - 63 kg.
226x84x78 cm.
1 pc [carton]

Frame Finishing & Codes / Finiture Telai e Codici

cod. 493, __/IF0A__
cod. 493, __/IMGA__

COM Fabric on request
Tessuto TC su richiesta

DKK - kr

21.195
21.195

**ETESIAN
MODULE 14**

Etesian chaise longue SX.
Chaise longue SX Etesian.

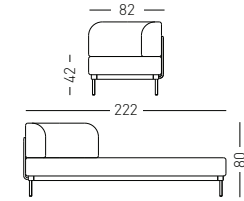

Feet to be assembled / Piedini da assemblare



1,48 m³ - 59 kg.
226x84x78 cm.
1 pc [carton]

Frame Finishing & Codes / Finiture Telai e Codici

cod. 494, __/IF0A__
cod. 494, __/IMGA__

COM Fabric on request
Tessuto TC su richiesta

DKK - kr

19.395
19.395

**ETESIAN
MODULE 15**

Etesian chaise longue DX.
Chaise longue DX Etesian.

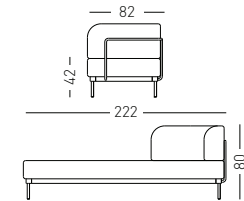

Feet to be assembled / Piedini da assemblare



1,48 m³ - 59 kg.
226x84x78 cm.
1 pc [carton]

Frame Finishing & Codes / Finiture Telai e Codici

cod. 495, __/IF0A__
cod. 495, __/IMGA__

COM Fabric on request
Tessuto TC su richiesta

DKK - kr

19.395
19.395

**ETESIAN
MODULE 16**

Etesian chaise longue
with long back support.
Chaise longue con supporto
schienale lungo Etesian.

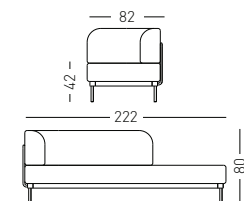

Feet to be assembled / Piedini da assemblare



1,48 m³ - 70 kg.
226x84x78 cm.
1 pc [carton]

Frame Finishing & Codes / Finiture Telai e Codici

cod. 496, __/IF0A__
cod. 496, __/IMGA__

COM Fabric on request
Tessuto TC su richiesta

DKK - kr

21.695
21.695

**ETESIAN
MODULE 17**

Etesian vis-a-vis version.
Versione vis a vis Etesian.

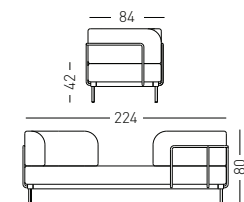

Feet to be assembled / Piedini da assemblare



1,48 m³ - 72 kg.
226x84x78 cm.
1 pc [carton]

Frame Finishing & Codes / Finiture Telai e Codici

cod. 497, __/IF0A__
cod. 497, __/IMGA__

COM Fabric on request
Tessuto TC su richiesta

DKK - kr

22.295
22.295

Extreme



Available colors / Colori disponibili

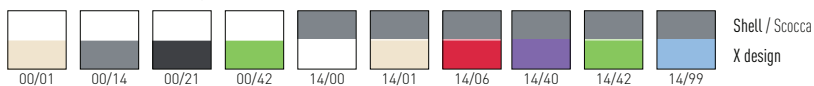

Shell / Scocca
X design

EXTREME



Painted 4-Legged metal frame,
techno-polymer multicolor shell.
Struttura in metallo 4 gambe
verniciata, scocca in tecnopolimero
multicolore.

CATAS
TESTATO - TESTED



only for painted frames
solo per telai verniciati

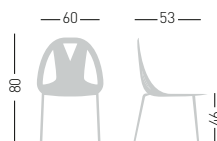

NA not assembled / non assemblato



0,24 m³ - 26 kg.
64x64x64cm.
4 pcs [carton]

Frame Finishing & Codes / Finiture Telai e Codici

cod.83.--/NAB white painted/verniciato bianco

DKK - kr

1.295

Finferlo



Available coverings / Finiture disponibili
King fabric / Tessuto King **K** (4pcs min.)

FINFERLO



Padded and upholstered
King fabric ottoman.
Pouf imbottito e tappezzato
in tessuto King.

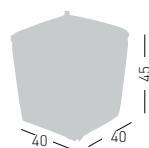

A assembled / assemblato



0,12 m³ - 4 kg.
43x46x60cm.
1 pcs [carton]

Frame Finishing & Codes / Finiture Telai e Codici

cod.250.--

The external covering is always grey.
Rivestimento esterno sempre grigio.

DKK - kr

2.595

Min. order 4pcs
each code
Ordine min 4pz
per codice

Flap



Available colors / Colori disponibili



IGN Versions follows UNI 9177 certification in terms of Fire Resistance, Fire Reaction Class 1
Versioni IGN prodotto Omologato con Classe di Reazione al fuoco 1, UNI 9177



FLAP

Techno-polymer folding chair.
Seduta pieghevole in tecnopolimero.



Chairs can be piled / Sedie accatastabili
A assembled / assemblato



0,08 m³ - 12 kg.
108x49x15cm.
2 pcs [carton]

Frame Finishing & Codes / Finiture Telai e Codici

cod.150. __/A

cod.150. __/IGN fire retardant / ignifuga

Min. order 200pcs each code / Ordine min 200pz per codice

DKK - kr

795

995

FLAP WALL HANGER AGGANCI A MURO

Technopolimer wall hanging
to mount 2 chairs, black and white.
Aggancio a muro in tecnopolimero
per 2 sedie, nero e bianco.



Available colors / Colori disponibili

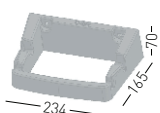
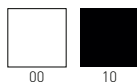

0,003 m³ - 0,26 kg.
8x24x17cm.
1 pcs [carton]

Codes / Codici

cod. 1064. __

DKK - kr

175

FLAP CONNECTING SYSTEM GANCI CONNESSIONE

Technopolimer linking devices for in-line disposal, white neutral color.
Agganci in tecnopolimero per disporre le sedute in linea, colore bianco neutro.

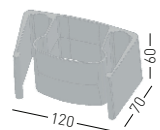
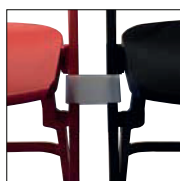

0,001 m³ - 1,6 kg.
14x13,5x46cm.
12 pcs [carton]

Codes / Codici

cod. 1007

DKK - kr

100

FLAP
TROLLEY
CARRELLO



Trolley for chairs, black painted metal structure with heavy duty castors, complete with adjustable safety strap.

Carrello porta sedie, struttura in metallo verniciato nero con ruote ad alta resistenza, completa di cinghia regolabile di sicurezza.



Max 24 chairs in a trolley
Massimo 24 sedie in un carrello



0,12 m³ - 10,20 kg.
123x62x16cm.
1 pcs [carton]

Codes / Codici

cod. 2004/A

DKK - kr

2.375

Fuller



Available colors / Colori disponibili

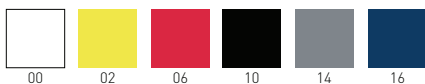

FULLER



Painted 4-legged metal frame, techno-polymer shell.
Struttura 4 gambe in metallo verniciata, scocca in tecnopolimero.



Legs and shell colors can be combined.
I colori della struttura e della scocca possono essere abbinati.

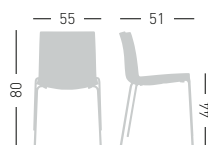

stackable / impilabile (6pcs)
A assembled / assemblato



0,38 m³ - 19 kg.
59x65x99cm.
4 pcs [carton]

Frame Finishing & Codes / Finiture Telai e Codici

cod.377._/AB
cod.377._/AN
cod.377._/AG
cod.377._/A06
cod.377._/A02
cod.377._/A16

DKK - kr

1.495
1.495
1.495
1.495
1.495
1.495

FULLER B



Painted 4-legged metal frame with armrests, techno-polymer shell.
Struttura 4 gambe in metallo verniciata con braccioli, scocca in tecnopolimero.



Legs and shell colors can be combined.
I colori della struttura e della scocca possono essere abbinati.

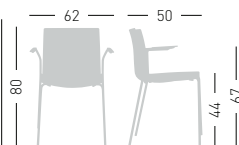

stackable / impilabile (6pcs)
A assembled / assemblato



0,3 m³ - 12 kg.
54x60x92cm.
2 pcs [carton]

Frame Finishing & Codes / Finiture Telai e Codici

cod.377._/TBB
cod.377._/TBN
cod.377._/TBG
cod.377._/TB06
cod.377._/TB02
cod.377._/TB16

DKK - kr

1.795
1.795
1.795
1.795
1.795
1.795

FULLER ST



Painted sled metal frame, techno-polymer shell.
Struttura a slitta verniciata in metallo, scocca in tecnopolimero.



Legs and shell colors can be combined.
I colori della struttura e della scocca possono essere abbinati.

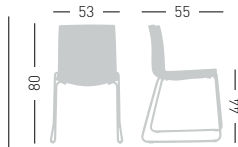

stackable / impilabile (6pcs)
A assembled / assemblato



0,38 m³ - 19 kg.
59x65x99cm.
4 pcs [carton]

Frame Finishing & Codes / Finiture Telai e Codici

cod.377. __/STB
cod.377. __/STN
cod.377. __/STG
cod.377. __/ST06
cod.377. __/ST02
cod.377. __/ST16

DKK - kr

1.495
1.495
1.495
1.495
1.495
1.495

FULLER TC



Painted wire steel metal, techno-polymer shell.
Struttura a traliccio in filo verniciata in metallo, scocca in tecnopolimero.



Legs and shell colors can be combined.
I colori della struttura e della scocca possono essere abbinati.

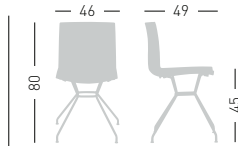

A assembled / assemblato



0,3 m³ - 6 kg.
54x60x92cm.
1 pcs [carton]

Frame Finishing & Codes / Finiture Telai e Codici

cod.377. __/TCB
cod.377. __/TCN
cod.377. __/TCG
cod.377. __/TC06
cod.377. __/TC02
cod.377. __/TC16

DKK - kr

2.295
2.295
2.295
2.295
2.295
2.295

FULLER TCS



Painted wire steel metal with armrests, techno-polymer shell.
Struttura a traliccio in filo verniciata in metallo con braccioli, scocca in tecnopolimero.



Legs and shell colors can be combined.
I colori della struttura e della scocca possono essere abbinati.

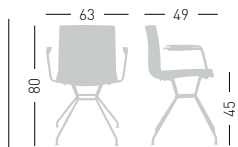

A assembled / assemblato



0,3 m³ - 7 kg.
54x60x92cm.
1 pcs [carton]

Frame Finishing & Codes / Finiture Telai e Codici

cod.377. __/TCSB
cod.377. __/TCSN
cod.377. __/TCSG
cod.377. __/TCS06
cod.377. __/TCS02
cod.377. __/TCS16

DKK - kr

2.495
2.495
2.495
2.495
2.495
2.495

Grand Minush



Available colors / Colori disponibili



GRAND MINUSH

Techno-polymer armchair with co-injected metal frame.
Poltrona in tecnopolimero con telaio metallico co-iniettato.

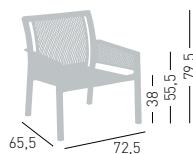

NA not assembled / non assemblato



0,39 m³ - 21 kg.
58x80x83cm.
2 pcs [carton]

Frame Finishing & Codes / Finiture Telai e Codici

cod.222.--/NA

DKK - kr

2.195

MINUSH SOFA

2 seat techno-polymer bench with co-injected metal frame.
Panca 2 posti in tecnopolimero con telaio metallico co-iniettato.

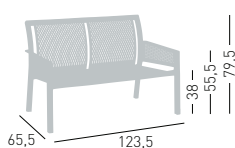

NA not assembled / non assemblato



0,39 m³ - 18 kg.
58x80x83cm.
1 pc [carton]

Frame Finishing & Codes / Finiture Telai e Codici

cod.223.--/NA

DKK - kr

3.695

GRAND MINUSH CUSHION / CUSCINO

Cushions set, seat and back.
Set cuscini, sedile e schienale.



Available fabric / Tessuti disponibili
Progarden fabric / Tessuto Progarden **GR**
Silvertex Fabric / Tessuto Silvertex **SX**
Maglia fabric / Tessuto Maglia **MG**



Inside armchair boxes
Nella scatola dette poltrona.

Frame Finishing & Codes / Finiture Telai e Codici

cod.320.-- (GR)

cod.320.-- (SX)

cod.320.-- (MG)

DKK - kr

1.050

1.300

1.300

Min. order 2pcs
each code
Ordine min 2pz
per codice

MINUSH SOFA
CUSHION / CUSCINO



Cushions set, seat and back.
Set cuscini, sedile e schienale.

Available fabric / Tessuti disponibili
Progarden fabric / Tessuto Progarden **GR**
ilvertex Fabric / Tessuto Silvertex **SX**
Maglia fabric / Tessuto Maglia **MG**



Inside bench boxes
Nella scatola
delle panche.

Frame Finishing & Codes / Finiture Telai e Codici

cod.323.-- (GR)
cod.323.-- (SX)
cod.323.-- (MG)

DKK - kr

1.650
1.975
1.975



Harmony

Available colors / Colori disponibili



HARMONY BTP



Swivel on polymer-metal co-injected base, diam. 40cm. Height adjustable, techno-polymer shell.
Girevole su basamento co-iniettato metallo-polimero diam. 40cm, regolabile in altezza, scocca in tecnopolimero.

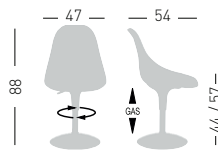

NA not assembled / non assemblato



0,2 m³ - 18,6 kg.
48x61x66,5cm.
2 pcs [carton]

Frame Finishing & Codes / Finiture Telai e Codici

cod.24.--/BTP

DKK - kr

1.595

HARMONY BTV



Swivel on chromed metal base, diam. 44cm. Height adjustable, techno-polymer shell.
Girevole su basamento in metallo cromato diam. 44cm, regolabile in altezza, scocca in tecnopolimero.

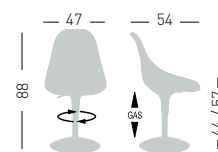

NA not assembled / non assemblato



0,2 m³ - 17,8 kg.
48x61x66,5cm.
2 pcs [carton]

Frame Finishing & Codes / Finiture Telai e Codici

cod.24.--/BTV

DKK - kr

1.695

HARMONY BC



Swivel on 5-spur base with castors, height adjustable, techno-polymer shell.

Girevole su basamento 5 razze con ruote, regolabile in altezza, scocca in tecnopolimero.

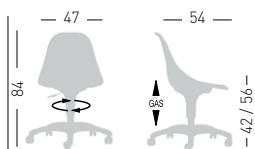

NA not assembled / non assemblato



0,2 m³ - 15 kg.
48x61x66,5cm.
2 pcs (carton)

Frame Finishing & Codes / Finiture Telai e Codici

cod.24.--/BC

DKK - kr

1.495

HARMONY BP



Swivel on 4-spur plastic grey base, height adjustable, techno-polymer shell.

Girevole su basamento 4 razze in plastica grigio, regolabile in altezza, scocca in tecnopolimero.

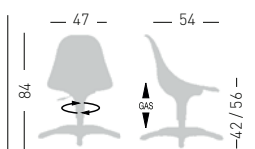

NA not assembled / non assemblato



0,2 m³ - 12 kg.
48x61x66,5cm.
2 pcs (carton)

Frame Finishing & Codes / Finiture Telai e Codici

cod.24.--/BP

DKK - kr

1.195

HARMONY PG



2-3-4-5 seat benches, metal-polymer co-injected legs, techno-polymer shell. Panca a 2-3-4-5 posti, gambe co-iniettate in metallo-polimero, scocca in tecnopolimero.

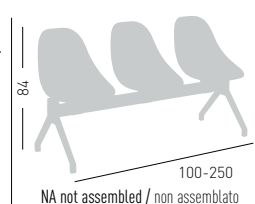

NA not assembled / non assemblato



0,28 m³ - 18,5 kg.
1 pcs (carton)

Frame Finishing & Codes / Finiture Telai e Codici

cod.24.--/PG2P (100 cm)

DKK - kr

3.595

0,29 m³ - 21,7 kg.
1 pcs (carton)

cod.24.--/PG3P (150 cm)

3.995

0,30 m³ - 25 kg.
1 pcs (carton)

cod.24.--/PG4P (200 cm)

4.395

0,31 m³ - 29,2 kg.
1 pcs (carton)

cod.24.--/PG5P (250 cm)

4.795

It is possible to change a seat with a grey metal top
È possibile sostituire la seduta con un tavolino in metallo grigio

HARMONY CUSHION / CUSCINO



Upholstered cushion. Cuscino tappezzato.

Available fabric. Tessuti disponibili.

E, K
COM fabric / Tessuto cliente **TC**



0,5 kg
Inside chairs boxes
Inseriti nella scatola delle sedie

Frame Finishing & Codes / Finiture Telai e Codici

cod.301.--

cod.301.TC COM fabric/tessuto cliente

DKK - kr

475

400

Fabric required
Fabbisogno di tessuto
4 pcs: Lin Mtrs 1 (h1,40)

COM fabric min. order
10pcs each code
Tessuto cliente TC ordine
min. 10pz per codice

Min. order 4pcs
each code
Ordine min 4pz
per codice

Iris



Available colors / Colori disponibili



IGN Versions follows UNI 9177 certification in terms of
Fire Resistance, Fire Reaction Class 1
Versioni IGN prodotto Omologato con Classe di Reazione al
fuoco 1, UNI 9177



IRIS



4 legget polymer-metal co-injected structure, techno-polymer shell.
Struttura 4 gambe in co-iniezione metallo-polimero, scocca in tecnopolimero.



CAM ARREDI

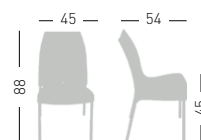

stackable / impilabile (5pcs)

A assembled / assemblato



0,39 m³ - 18 kg.
50x73x102cm.
4 pcs [carton]

Frame Finishing & Codes / Finiture Telai e Codici

cod.181.--/A

DKK - kr

795

cod.181.--/IGNA fire retardant / ignifuga

Min. order 300pcs each code / Ordine min 300pz per codice

995

IRIS B



4 legget polymer-metal co-injected structure, techno-polymer shell with arms.
Struttura 4 gambe in co-iniezione metallo-polimero, scocca in tecnopolimero con braccioli.



CAM ARREDI

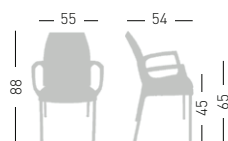

stackable / impilabile (5pcs)

A assembled / assemblato



0,46 m³ - 19 kg.
58x75x102cm.
4 pcs [carton]

Frame Finishing & Codes / Finiture Telai e Codici

cod.182.--/A

DKK - kr

895

cod.182.--/IGNA fire retardant / ignifuga

Min. order 300pcs each code / Ordine min 300pz per codice

1.295

IRIS BL



4-Legged wooden beech legs, techno-polymer shell.
Struttura 4 gambe in legno di faggio, scocca in tecnopolimero.



Price + DKK 150

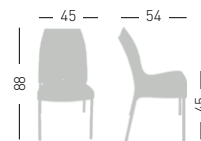

A assembled / assemblato



0,46 m³ - 18,8 kg.
58x75x102cm.
4 pcs [carton]

Frame Finishing & Codes / Finiture Telai e Codici

cod.181.--/BL_

Min. order 100pcs each code / Ordine min 100pz per codice

DKK - kr

1.095

Felt Glides / Tappi in feltro

IRIS BL B



4-Legged wooden beech legs, techno-polymer shell with armrests.
Struttura 4 gambe in legno di faggio, scocca in tecnopolimero con braccioli.

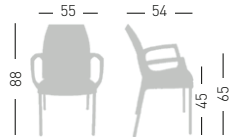

A assembled / assemblato



0,46 m³ - 19,8 kg.
58x75x102cm.
4 pcs [carton]

Frame Finishing & Codes / Finiture Telai e Codici

cod.182.--/BL_

Min. order 100pcs each code / Ordine min 100pz per codice

Felt Glides / Tappi in feltro

DKK - kr

1.195

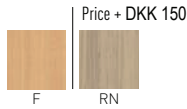

IRIS CHAIRS TROLLEY CARRELLO PER SEDIE



Trolley for chairs model Iris, black painted.
Carrello porta sedie modello Iris, verniciato nero.

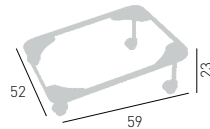

0,09 m³ - 5,5kg
61x54x25cm.
1 pcs [carton]

Frame Finishing & Codes / Finiture Telai e Codici

cod.2002/A

DKK - kr

1.275



Isidora

Available colors / Colori disponibili

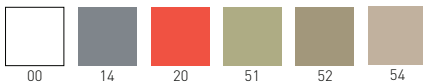

ISIDORA



4-legged stackable techno-polymer chair.
Seduta impilabile in tecnopolimero.

CATAS
TESTATO - TESTED

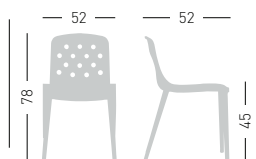

stackable / impilabile (6pcs)
A assembled / assemblato



0,38 m³ - 16 kg.
59x72x90cm.
4 pcs [carton]

Frame Finishing & Codes / Finiture Telai e Codici

cod.380.--/A

DKK - kr

995

ISIDORA B



4-legged stackable techno-polymer chair with armrests.
Seduta impilabile in tecnopolimero con braccioli.

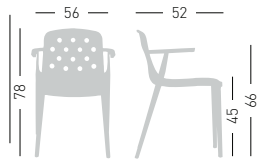

stackable / impilabile (6pcs)
A assembled / assemblato



0,38 m³ - 18,4 kg.
59x72x90cm.
4 pcs [carton]

Frame Finishing & Codes / Finiture Telai e Codici

cod.381.--/A

DKK - kr

1.095

ISIDORA CUSHION / CUSCINO

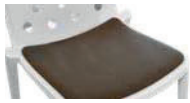

Cushion available with Aurea eco-leather or King fabric.
Cuscino Ecopelle Aurea o tessuto King.

Available fabric.
Tessuti disponibili.

E, K
COM fabric / Tessuto cliente **TC** (10 pcs min)



0,6 kg
Inside chairs boxes
Inseriti nella scatola delle sedie

Frame Finishing & Codes / Finiture Telai e Codici

cod.312.--

cod.312.TC COM fabric/tessuto cliente

DKK - kr

**550
475**

Fabric required
Fabbisogno di tessuto
4 pcs: Lin Mtrs 1,0 (h1,40)

COM fabric min. order
10pcs each code
Tessuto cliente TC ordine
min. 10pz per codice

Min. order 4pcs
each code
Ordine min 4pz
per codice

ISIDORA UPHOLSTERED IMBOTTITE

Available coverings / Finiture disponibili
Aurea eco-leather / Ecopelle Aurea **E** (4pcs min.)
King fabric / Tessuto King **K** (4pcs min.)
COM fabric / Tessuto cliente **TC** (10pcs min.)

DRESS ISIDORA



Techno-polymer upholstered chair.
Seduta in tecnopolimero rivestita.

Glossy back coverings colors can be combined with the shell.
I colori dei retro-schienali lucidi possono essere abbinati alla scocca.

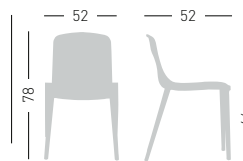

NA seat panel not assembled /
cuscino non assemblato



0,38 m³ - 21,2 kg.
59x72x90cm.
4 pcs [carton]

Frame Finishing & Codes / Finiture Telai e Codici

cod.380.--.--/IEA

cod.380.--.--/IKA

cod.380.--.--/ITCA COM fabric/tessuto cliente

DKK - kr

**2.095
2.095
1.895**

Fabric required
Fabbisogno di tessuto
2 pcs: Lin Mtrs 1,5 (h1,40)

COM fabric min. order
10pcs each code
Tessuto cliente TC ordine
min. 10pz per codice

Min. order 4pcs
each code
Ordine min 4pz
per codice

DRESS ISIDORA B



Techno-polymer upholstered chair with armrests.
Seduta in tecnopolimero rivestita con braccioli.

Glossy back coverings colors can be combined with the shell.
I colori dei retro-schienali lucidi possono essere abbinati alla scocca.

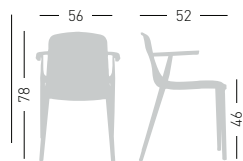

NA seat panel not assembled /
cuscino non assemblato



0,38 m³ - 23,6 kg.
59x72x90cm.
4 pcs [carton]

Frame Finishing & Codes / Finiture Telai e Codici

cod.381.--.--/IEA

cod.381.--.--/IKA

cod.381.--.--/ITCA COM fabric/tessuto cliente

DKK - kr

**2.195
2.195
1.995**

Fabric required
Fabbisogno di tessuto
2 pcs: Lin Mtrs 1,5 (h1,40)

COM fabric min. order
10pcs each code
Tessuto cliente TC ordine
min. 10pz per codice

Min. order 4pcs
each code
Ordine min 4pz
per codice

Jubel



IGN Versions follows UNI 9177 certification in terms of Fire Resistance, Fire Reaction Class 1
Versioni IGN prodotto Omologato con Classe di Reazione al fuoco 1, UNI 9177



Available colors / Colori disponibili

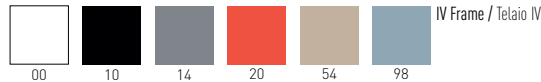
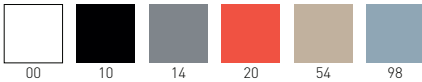

JUBEL NA



Chromed or painted 4-Legged metal frame, techno-polymer shell.
Struttura in metallo 4 gambe, cromata o verniciata, scocca in tecnopolimero.



CAM ARREDI



only for painted frames
solo per telai verniciati

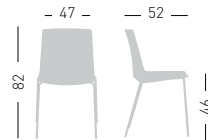

stackable / impilabile (5pcs)

NA not assembled / non assemblato



0,25 m³ - 21 kg.
67x56x64,5cm.
4 pcs [carton]

Frame Finishing & Codes / Finiture Telai e Codici

cod.291.__/NA chromed/cromata
cod.291.__/NAB white painted/verniciato bianco
cod.291.__/NAN black painted/verniciato nero

DKK - kr

1.095

1.195

1.395

cod.291.__/IGNNA

fire retardant, chromed framed
ignifuga, telaio cromato

Minimum order 300pcs/ Ordine minimo 300pz

JUBEL TB



Chromed or painted 4-Legged metal frame with armrests, techno-polymer shell.
Struttura in metallo 4 gambe con braccioli, cromata o verniciata, scocca in tecnopolimero.



only for painted frames
solo per telai verniciati

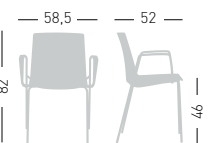

stackable / impilabile (4pcs)

NA not assembled / non assemblato



0,31 m³ - 13 kg.
61x55x93cm.
2 pcs [carton]

Frame Finishing & Codes / Finiture Telai e Codici

cod.291.__/TB chromed/cromata
cod.291.__/TBB white painted/verniciato bianco
cod.291.__/TBN black painted/verniciato nero

DKK - kr

1.595

1.695

1.695

Armrest white for shells cod. 00-52-54-98

Armrest black for shells cod. 10-14-20

Bracciolo bianco per scocche cod. 00-52-54-98

Bracciolo nero per scocche cod. 10-14-20

In case of painted frame, armrests color are combined with frame colors.
Nel caso di telai verniciati, il colore dei braccioli segue il colore dei telai.

JUBEL S



Chromed or painted wire steel sled frame, techno-polymer shell.
Struttura a slitta in filo, cromata o verniciata, scocca in tecnopolimero.



only for painted frames
solo per telai verniciati

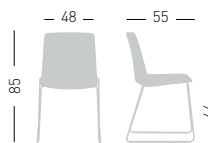

stackable / impilabile (8pcs)

NA not assembled / non assemblato



0,25 m³ - 24 kg.
67x56x64,5cm.
4 pcs [carton]

Frame Finishing & Codes / Finiture Telai e Codici

cod.291.__/S chromed/cromata
cod.291.__/SB white painted/verniciato bianco
cod.291.__/SN black painted/verniciato nero

DKK - kr

1.095

1.195

1.195

JUBEL SS



Chromed or white painted wire steel sled frame with armrests, techno-polymer shell.
Struttura a slitta in filo con braccioli, cromata o verniciata bianca, scocca in tecnopolimero.



only for painted frames
solo per telai verniciati

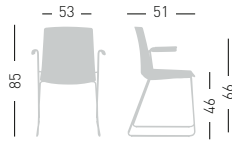

stackable / impilabile (8pcs)
NA not assembled / non assemblato



0,31 m³ - 13,50 kg.
61x55x73cm.
2 pcs [carton]

Frame Finishing & Codes / Finiture Telai e Codici

cod.291.__/SS chromed/cromata
cod.291.__/SSB white painted/verniciato bianco

DKK - kr

1.595
1.695

The arm pads are in the same color of the shell
Il copribrafcio è dello stesso colore della scocca

JUBEL BL



4-Legged wooden beech frame, techno-polymer shell.
Struttura in legno di faggio 4 gambe, scocca in tecnopolimero.

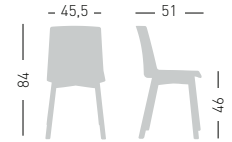

NA not assembled / non assemblato

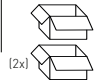

0,32 m³ - 28 kg.
60x56x51cm.



75x55x17cm.
4 pcs [carton]

Frame Finishing & Codes / Finiture Telai e Codici

cod.291.__/BLF

DKK - kr

2.395

Felt Glides / Tappi in feltro

JUBEL 5R



Swivel on 5-blade polished aluminum base, height adjustable, techno-polymer shell with castors.
Girevole su basamento 5 razze in alluminio pulito con ruote, regolabile in altezza, scocca in tecnopolimero.

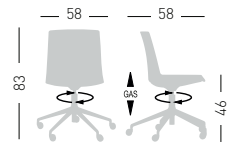

NA not assembled / non assemblato



0,24 m³ - 19 kg.
66x55x63cm.
2 pcs [carton]

Frame Finishing & Codes / Finiture Telai e Codici

cod.291.__/5R polished/lucida

DKK - kr

2.295

JUBEL 5R BRACCIOLO



Swivel on 5-blade polished aluminum base, height adjustable, techno-polymer shell, armrests with castors.
Girevole su basamento 5 razze in alluminio pulito con ruote, regolabile in altezza, scocca in tecnopolimero, braccioli.

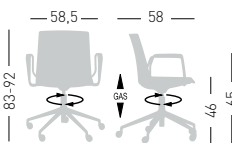

NA not assembled / non assemblato



0,24 m³ - 22 kg.
66x55x63cm.
2 pcs [carton]

Frame Finishing & Codes / Finiture Telai e Codici

cod.291.___/5RB polished/lucida

DKK - kr

2.495

Armrest white for shells cod. 00-14-20-52-54-98
Armrest black for shells cod. 10
Bracciolo bianco per scocche cod. 00-14-20-52-54-98
Bracciolo nero per scocche cod.10

JUBEL L



Swivel on 4-blade polished aluminum base, techno-polymer shell.
Girevole su basamento 4 razze in alluminio pulito, scocca in tecnopolimero.

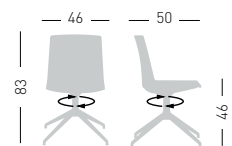

NA not assembled / non assemblato



0,24 m³ - 16 kg.
66x55x63cm.
2 pcs [carton]

Frame Finishing & Codes / Finiture Telai e Codici

cod.291.__/L polished/lucida

DKK - kr

2.195

Felt Glides / Tappi in feltro

JUBEL L BRACCIOLO



Swivel on 4-blade polished aluminum base, techno-polymer shell, armrests. Girevole su basamento 4 razze in alluminio pulito, scocca in tecnopolimero, braccioli.

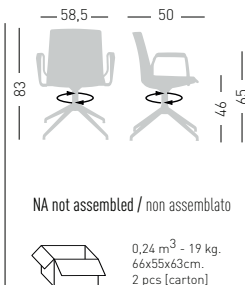

NA not assembled / non assemblato



Frame Finishing & Codes / Finiture Telai e Codici

cod.291.____/LB polished/lucida

Armrest white for shells cod. 00-14-20-52-54-98
Armrest black for shells cod. 10
Bracciolo bianco per scocche cod. 00-14-20-52-54-98
Bracciolo nero per scocche cod.10

Felt Glides / Tappi in feltro

DKK - kr

2.295

JUBEL IV



4-legged polymer-steel coinject structure, techno-polymer shell. Struttura 4 gambe in co-iniezione metallo-polimero, scocca in tecnopolimero.

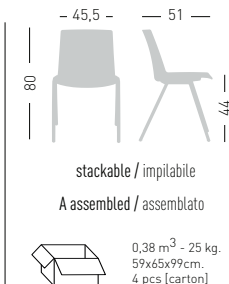

stackable / impilabile

A assembled / assemblato



Frame Finishing & Codes / Finiture Telai e Codici

cod.291.____/IV____

cod.291.____/IGNIV_ fire retardant / ignifuga
Min. order 300pcs each code / Ordine min 300pz per codice

DKK - kr

1.395

1.695

JUBEL IVB



4-legged polymer-steel coinject structure with armrests, techno-polymer shell. Struttura 4 gambe in co-iniezione metallo-polimero con braccioli, scocca in tecnopolimero.

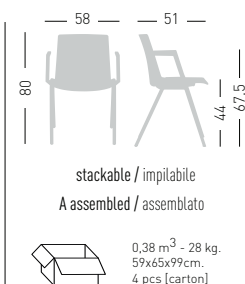

stackable / impilabile

A assembled / assemblato



Frame Finishing & Codes / Finiture Telai e Codici

cod.291.____/IVB____

cod.291.____/IGNIVB____ fire retardant / ignifuga
Min. order 300pcs each code / Ordine min 300pz per codice

DKK - kr

1.895

2.195

JUBEL IVBT



4-legged polymer-steel coinject structure with armrests and antipanic tablet, techno-polymer shell. Struttura 4 gambe in co-iniezione metallo-polimero con braccioli e tavoletta antipanico, scocca in tecnopolimero.

Frame / Telaio

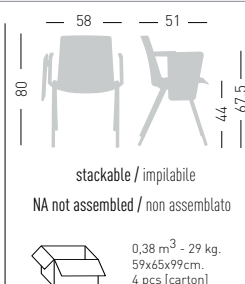

stackable / impilabile

NA not assembled / non assemblato



Frame Finishing & Codes / Finiture Telai e Codici

cod.291.____/IVB_T

cod.291.____/IGNIVB_T fire retardant / ignifuga
Min. order 300pcs each code / Ordine min 300pz per codice

DKK - kr

2.595

2.895

JUBEL PG



2-3-4-5 seat benches, metal-polymer co-injected legs, techno-polymer shell. Panca a 2-3-4-5 posti, gambe co-iniettate in metallo-polimero, scocca in tecnopolimero.



CAM ARREDI

TP COSMOB

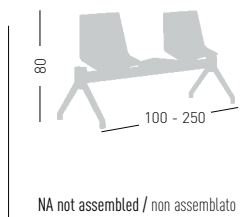

NA not assembled / non assemblato



Frame Finishing & Codes / Finiture Telai e Codici

cod.291.____/PG2P____ (100 cm)

cod.291.____/PG3P____ (150 cm)

cod.291.____/PG4P____ (200 cm)

cod.291.____/PG5P____ (250 cm)

DKK - kr

3.895

4.395

4.895

5.395

Bench legs available colors: 00-06-10-13-14-33-34-42
It is possible to change a seat with a grey metal top.
Outdoor version on request.

Colori disponibili gambe panca: 00-06-10-13-14-33-34-42
È possibile sostituire la seduta con un tavolino in metallo grigio. Versione per esterni su richiesta.

JUBEL
CUSHION / CUSCINO



Upholstered cushion.
Cuscino tappezzato.

Available fabric.
Tessuti disponibili.

B, E, K, DK
COM fabric / Tessuto cliente **TC**



0,5 kg.
Inside chairs
boxes
Nella scatola
delle sedie.

Frame Finishing & Codes / Finiture Telai e Codici

cod.315.-- (B)
cod.315.-- (E)
cod.315.-- (K)
cod.315.-- (DK)
cod.315.TC COM fabric/tessuto cliente

DKK - kr

600
550
650
475

Minimum order 4pcs each code
Ordine minimo 4 pezzi per codice

COM fabric minimum order 10pcs each code
Tessuto cliente TC ordine minimo 10pz per codice

Fabric required / Fabbisogno di tessuto
4 pcs : Lin Mtrs 1 (h1,40)

JUBEL
CONNECTING SYSTEM
GANCIO CONNESSIONE



Extensible chromed linking devices
for in-line disposal.
Agganci estensibili cromati per disporre
le sedute in linea.



Inside chairs
boxes
Nella scatola
delle sedie.

Frame Finishing & Codes / Finiture Telai e Codici

cod.1004

DKK - kr

250

available for models: NA, TB, S, SS, SST
disponibile per versioni: NA, TB, S, SS, SST

JUBEL
CONNECTING SYSTEM
GANCIO CONNESSIONE



Set linking glides for in-line disposal.
Set piedini con agganci per disporre le
sedute in linea.



Inside chairs
boxes
Nella scatola
delle sedie.

Frame Finishing & Codes / Finiture Telai e Codici

cod.1014

DKK - kr

125

Assembled / assemblato

available for models: S, SST
disponibile per versioni: S, SST

JUBEL IV
CONNECTING SYSTEM
GANCIO CONNESSIONE



Extensible techno-polymer linking
devices for in-line disposal.
Agganci estensibili in tecnopolimero per
disporre le sedute in linea.



Inside chairs
boxes
Nella scatola
delle sedie.

Frame Finishing & Codes / Finiture Telai e Codici

cod.1024.10

DKK - kr

250

Assembled / assemblato

available for models: IV
disponibile per versioni: IV

JUBEL
CHAIRS TROLLEY
CARRELLO PER SEDIE



Trolley for chairs, chromed metal
structure.
Carrello porta sedie, struttura
in metallo cromato.



0,3 m³ - 10kg
63x75x58cm.
1 pcs (carton)

Frame Finishing & Codes / Finiture Telai e Codici

cod.2000/A

DKK - kr

2.075

available for models: S-SS
disponibile per versioni: S-SS

stackable on trolley 18 pcs
impilabili su carrello 18 pcs

max height with 18 chairs 188 cm
altezza carrello con 18 sedie 188 cm

JUBEL
CHAIRS TROLLEY
CARRELLO PER SEDIE



Painted grey adjustable Dolly, for 4 legged chairs.
Carrello per sedie 4 gambe, regolabile, verniciato grigio.

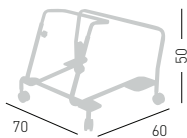

Frame Finishing & Codes / Finiture Telai e Codici

cod.2001/A

available for models: NA
disponibile per versioni: NA

DKK - kr

2.275



0,3 m³ - 8kg
62x72x51cm.
1 pcs [carton]

JUBEL IV
CHAIRS TROLLEY
CARRELLO PER SEDIE



Trolley for chairs, black painted.
Carrello porta sedie, verniciato nero.

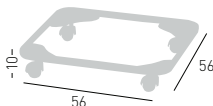

Frame Finishing & Codes / Finiture Telai e Codici

cod.2003/A

available for models: IV
disponibile per versioni: IV

DKK - kr

1.475



0,09 m³ - 6kg
61x61x20cm.
1 pcs [carton]

JUBEL
UPHOLSTERED
IMBOTTITE

Available coverings / Rivestimenti disponibili
Aurea eco-leather / Ecopelle Aurea **E** (4pcs min.)
King fabric / Tessuto King **K** (4pcs min.)
Kvadrat fabrics / Tessuti Kvadrat **DK** (4pcs min.)
COM fabric / Tessuto cliente **TC** (10pcs min.)

Products follows UNI 9175 -UNI 9175/FA, in terms of Fire Resistance, Fire Reation Class 11M
Prodotto Omologato dal Ministero dell'Interno, secondo la UNI 9175 -UNI 9175/FA, con classe di Reazione al fuoco 11M



JUBEL NA
UPHOLSTERED



PU-Flex padded and upholstered shell, chromed or painted 4 legged metal frame.
Scocca imbottita in PU-Flex e rivestita, telaio 4 gambe in metallo cromato o verniciato.

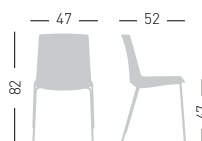

NA not assembled / non assemblato



0,25 m³ - 14 kg.
67x56x64,5cm.
2 pcs [carton]

Frame Finishing & Codes / Finiture Telai e Codici

cod.291._/IENA chromed/cromata
cod.291._/IENAB white painted/verniciato bianco
cod.291._/IENAN black painted/verniciato nero
cod.291._/IKNA chromed/cromata
cod.291._/IKNAB white painted/verniciato bianco
cod.291._/IKNAN black painted/verniciato nero
cod.291._/IDKNA chromed/cromata
cod.291._/IDKNAB white painted/verniciato bianco
cod.291._/IDKNAN black painted/verniciato nero
cod.291._/ITCNA chromed/cromata
cod.291._/ITCNAB white painted/verniciato bianco
cod.291._/ITCNAN black painted/verniciato nero

DKK - kr

2.195

2.295

2.295

2.195

2.295

2.295

2.795

2.995

2.995

1.895

2.095

2.095

Fabric required
Fabbisogno di tessuto
1 pcs: Lin Mtrs 1,0 (h1,40)

COM fabric min. order
10pcs each code
Tessuto cliente TC ordine
min. 10pz per codice

Min. order 4pcs
each code
Ordine min 4pz
per codice

JUBEL TB
UPHOLSTERED



PU-Flex padded and upholstered shell, chromed or painted 4 legged metal frame with armrests.
Scocca imbottita in PU-Flex e rivestita, telaio 4 gambe in metallo cromato o verniciato, con braccioli.

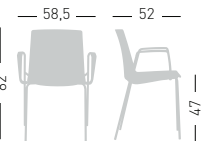

NA not assembled / non assemblato



0,31 m³ - 1.5 kg.
61x55x93cm.
2 pcs [carton]

Frame Finishing & Codes / Finiture Telai e Codici

cod.291._/IETB chromed/cromata
cod.291._/IETBB white painted/verniciato bianco
cod.291._/IETBN black painted/verniciato nero
cod.291._/IKTB chromed/cromata
cod.291._/IKTBB white painted/verniciato bianco
cod.291._/IKTBN black painted/verniciato nero
cod.291._/IDKTB chromed/cromata
cod.291._/IDKTB white painted/verniciato bianco
cod.291._/IDKTB black painted/verniciato nero
cod.291._/ITCTB chromed/cromata
cod.291._/ITCTBB white painted/verniciato bianco
cod.291._/ITCTBN black painted/verniciato nero

DKK - kr

2.495

2.595

2.595

2.495

2.595

2.595

3.195

3.295

3.295

2.295

2.395

2.395

Fabric required
Fabbisogno di tessuto
1 pcs: Lin Mtrs 1,0 (h1,40)

COM fabric min. order
10pcs each code
Tessuto cliente TC ordine
min. 10pz per codice

Min. order 4pcs
each code
Ordine min 4pz
per codice

Specify on the order the colour of the armrest: white or black
Specificare nell'ordine il colore del bracciolo: bianco o nero

JUBEL S
UPHOLSTERED



PU-Flex padded and upholstered shell, chromed or painted wire steel sled frame.
Scocca imbottita in PU-Flex e rivestita, telaio slitta in filo cromato o verniciato.

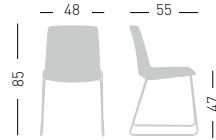

NA not assembled / non assemblato



0,25 m³ - 16 kg.
67x56x64,5cm.
2 pcs (carton)

Frame Finishing & Codes / Finiture Telai e Codici

cod.291. __/IES chromed/cromata
cod.291. __/IESB white painted/verniciato bianco
cod.291. __/IESN black painted/verniciato nero
cod.291. __/IKS chromed/cromata
cod.291. __/IKSB white painted/verniciato bianco
cod.291. __/IKSN black painted/verniciato nero
cod.291. __/IDKS chromed/cromata
cod.291. __/IDKSB white painted/verniciato bianco
cod.291. __/IDKSN black painted/verniciato nero
cod.291./ITCS chromed/cromata
cod.291./ITCSB white painted/verniciato bianco
cod.291./ITCSN black painted/verniciato nero

DKK - kr

2.195
2.295
2.295
2.195
2.295
2.295
2.795
2.995
2.995
1.895
2.095
2.095

Fabric required
Fabbisogno di tessuto
1 pcs: Lin Mtrs 1,0 (h1,40)

COM fabric min. order
10pcs each code
Tessuto cliente TC ordine
min. 10pz per codice

Min. order 4pcs
each code
Ordine min 4pz
per codice

JUBEL SS
UPHOLSTERED



PU-Flex padded and upholstered shell, chromed or painted wire steel sled frame with armrests.
Scocca imbottita in PU-Flex e rivestita, telaio slitta in filo cromato o verniciato con braccioli.

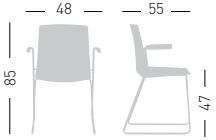

NA not assembled / non assemblato



0,31 m³ - 16 kg.
61x55x93cm.
2 pcs (carton)

Frame Finishing & Codes / Finiture Telai e Codici

cod.291. __/IESS chromed/cromata
cod.291. __/IESSB white painted/verniciato bianco
cod.291. __/IKSS chromed/cromata
cod.291. __/IKSSB white painted/verniciato bianco
cod.291. __/IDKSS chromed/cromata
cod.291. __/IDKSSB white painted/verniciato bianco
cod.291. __/ITCSS chromed/cromata
cod.291. __/ITCSSB white painted/verniciato bianco

DKK - kr

2.495
2.595
2.495
2.595
3.195
3.295
2.295
2.395

Fabric required
Fabbisogno di tessuto
1 pcs: Lin Mtrs 1,0 (h1,40)

COM fabric min. order
10pcs each code
Tessuto cliente TC ordine
min. 10pz per codice

Min. order 4pcs
each code
Ordine min 4pz
per codice

Specify on the order the colour of the armrest: white or black
Specificare nell'ordine il colore del bracciolo: bianco o nero

JUBEL BL
UPHOLSTERED



4-Legged wooden beech frame, PU-Flex padded and upholstered shell.
Struttura in legno di faggio 4 gambe, scocca imbottita in PU-Flex e rivestita

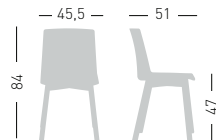

NA not assembled / non assemblato



0,32 m³ - 34 kg.
66x55x63cm.



75x55x17cm.
4 pcs (carton)

Frame Finishing & Codes / Finiture Telai e Codici

cod.291. __/IEBLF
cod.291. __/IKBLF
cod.291. __/IDKBLF
cod.291./ITCBLF

DKK - kr

3.295
3.295
3.895
2.995

Felt Glides / Tappi in feltro

Fabric required
Fabbisogno di tessuto
1 pcs: Lin Mtrs 1,0 (h1,40)

COM fabric min. order
10pcs each code
Tessuto cliente TC ordine
min. 10pz per codice

Min. order 4pcs
each code
Ordine min 4pz
per codice



JUBEL 5R
UPHOLSTERED



PU-Flex padded and upholstered shell, polished aluminum base with castors.
Scocca imbottita in PU-Flex e rivestita, base in alluminio pulito con ruote.

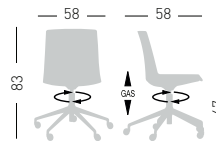

NA not assembled / non assemblato



0,24 m³ - 21 kg.
66x55x63cm.
2 pcs (carton)

Frame Finishing & Codes / Finiture Telai e Codici

cod.291. __/IE5R polished/lucida
cod.291. __/IK5R polished/lucida
cod.291. __/IDK5R cpolished/lucida
cod.291./ITC5R polished/lucida

DKK - kr

3.295
3.295
3.895
2.995

Fabric required
Fabbisogno di tessuto
1 pcs: Lin Mtrs 1,0 (h1,40)

COM fabric min. order
10pcs each code
Tessuto cliente TC ordine
min. 10pz per codice

Min. order 4pcs
each code
Ordine min 4pz
per codice

JUBEL L
UPHOLSTERED



PU-Flex padded and upholstered shell, polished aluminum base.
Scocca imbottita in PU-Flex e rivestita, base in alluminio pulito.

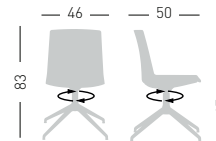

NA not assembled / non assemblato



0,24 m³ - 18 kg.
66x55x63cm.
2 pcs (carton)

Frame Finishing & Codes / Finiture Telai e Codici

cod.291. __/IEL polished/lucida
cod.291. __/IKL polished/lucida
cod.291. __/IDKL polished/lucida
cod.291./ITCL polished/lucida

DKK - kr

3.095
3.095
3.695
2.795

Felt Glides / Tappi in feltro

Fabric required
Fabbisogno di tessuto
1 pcs: Lin Mtrs 1,0 (h1,40)

COM fabric min. order
10pcs each code
Tessuto cliente TC ordine
min. 10pz per codice

Min. order 4pcs
each code
Ordine min 4pz
per codice

JUBEL 5R BRACCIOLO UPHOLSTERED



PU-Flex padded and upholstered shell, polished aluminum base with castors, armrests.
Scocca imbottita in PU-Flex e rivestita, base in alluminio pulito con ruote, braccioli.

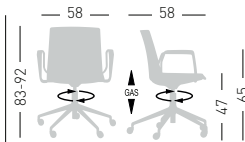

NA not assembled / non assemblato



Frame Finishing & Codes / Finiture Telai e Codici

cod.291._/IE5RB polished/lucida
cod.291._/IK5RB polished/lucida
cod.291._/IDK5RB polished/lucida
cod.291/ITC5RB polished/lucida

DKK - kr

3.795
3.795
4.495
3.595

Fabric required
Fabbisogno di tessuto
1 pcs: Lin Mtrs 1,0 (h1,40)

COM fabric min. order
10pcs each code
Tessuto cliente TC ordine
min. 10pz per codice

Min. order 4pcs
each code
Ordine min 4pz
per codice

Specify on the order the colour of the armrest: white or black
Specificare nell'ordine il colore del bracciolo: bianco o nero

JUBEL L BRACCIOLO UPHOLSTERED



PU-Flex padded and upholstered shell, polished aluminum base, armrests.
Scocca imbottita in PU-Flex e rivestita, base in alluminio pulito, braccioli.

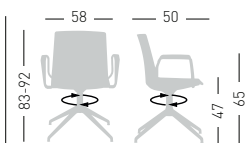

NA not assembled / non assemblato



Frame Finishing & Codes / Finiture Telai e Codici

cod.291._/IELB polished/lucida
cod.291._/IKLB polished/lucida
cod.291._/IDKLB polished/lucida
cod.291/ITCLB polished/lucida

DKK - kr

3.595
3.595
4.295
3.395

Felt Glides / Tappi in feltro

Fabric required
Fabbisogno di tessuto
1 pcs: Lin Mtrs 1,0 (h1,40)

COM fabric min. order
10pcs each code
Tessuto cliente TC ordine
min. 10pz per codice

Min. order 4pcs
each code
Ordine min 4pz
per codice

Specify on the order the colour of the armrest: white or black
Specificare nell'ordine il colore del bracciolo: bianco o nero

JUBEL IV UPHOLSTERED



4-legged polymer-steel coinjectured structure, PU-Flex padded and upholstered shell.
Struttura 4 gambe in co-iniezione metallo-polimero, scocca imbottita in PU-Flex e rivestita.

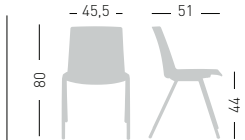

stackable / impilabile
NA not assembled / non assemblato



Frame Finishing & Codes / Finiture Telai e Codici

cod.291._/IEIV_
cod.291._/IKIV_
cod.291._/IDKIV_
cod.291/ITCIV_

DKK - kr

2.395
2.395
2.995
2.095

Fabric required
Fabbisogno di tessuto
1 pcs: Lin Mtrs 1,0 (h1,40)

COM fabric min. order
10pcs each code
Tessuto cliente TC ordine
min. 10pz per codice

Min. order 4pcs
each code
Ordine min 4pz
per codice

JUBEL IVB UPHOLSTERED



4-legged polymer-steel coinjectured structure with armrests, PU-Flex padded and upholstered shell.
Struttura 4 gambe in co-iniezione metallo-polimero con braccioli, scocca imbottita in PU-Flex e rivestita.

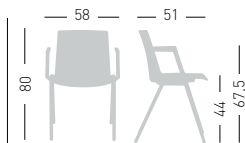

stackable / impilabile
NA not assembled / non assemblato

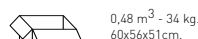

Frame Finishing & Codes / Finiture Telai e Codici

cod.291._/IEIVB_
cod.291._/IKIVB_
cod.291._/IDKIVB_
cod.291/ITCIVB_

DKK - kr

2.895
2.895
3.495
2.695

Fabric required
Fabbisogno di tessuto
1 pcs: Lin Mtrs 1,0 (h1,40)

COM fabric min. order
10pcs each code
Tessuto cliente TC ordine
min. 10pz per codice

Min. order 4pcs
each code
Ordine min 4pz
per codice

JUBEL IVBT UPHOLSTERED



4-legged polymer-steel coinjectured structure with armrests and antipanic tablet, PU-Flex padded and upholstered shell.
Struttura 4 gambe in co-iniezione metallo-polimero con braccioli e tavoletta antipanic, scocca imbottita in PU-Flex e rivestita.

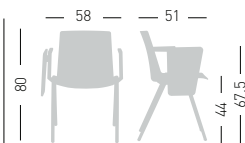

stackable / impilabile
NA not assembled / non assemblato



Frame Finishing & Codes / Finiture Telai e Codici

cod.291._/IEIVB_T
cod.291._/IKIVB_T
cod.291._/IDKIVB_T
cod.291/ITCIVB_T

DKK - kr

3.595
3.595
4.195
3.295

Fabric required
Fabbisogno di tessuto
1 pcs: Lin Mtrs 1,0 (h1,40)

COM fabric min. order
10pcs each code
Tessuto cliente TC ordine
min. 10pz per codice

Min. order 4pcs
each code
Ordine min 4pz
per codice

Frame / Telaio



JUBEL PG
UPHOLSTERED

PU-Flex padded and upholstered shell, bench version.
Scocca imbottita in PU-Flex e rivestita, versione panca.

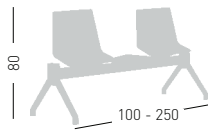

NA not assembled / non assemblato

Fabric required
Fabbisogno di tessuto
1 pcs: Lin Mtrs 1,0 (h1,40)



0,28 m³ - 30 kg.
55x66,5x63cm.
1 pcs [carton]

0,29 m³ - 36 kg.
55x66,5x63cm.
1 pcs [carton]

0,30 m³ - 43 kg.
55x66,5x63cm.
1 pcs [carton]

0,31 m³ - 47 kg.
55x66,5x63cm.
1 pcs [carton]

Frame Finishing & Codes / Finiture Telai e Codici

cod.291._/IEPG2P__ (100 cm)
cod.291._/IEPG3P__ (150 cm)
cod.291._/IEPG4P__ (200 cm)
cod.291._/IEPG5P__ (250 cm)
cod.291._/IKPG2P__ (100 cm)
cod.291._/IKPG3P__ (150 cm)
cod.291._/IKPG4P__ (200 cm)
cod.291._/IKPG5P__ (250 cm)
cod.291._/IDKPG2P__ (100 cm)
cod.291._/IDKPG3P__ (150 cm)
cod.291._/IDKPG4P__ (200 cm)
cod.291._/IDKPG5P__ (250 cm)
cod.291/ITCPG2P__ (100 cm)
cod.291/ITCPG3P__ (150 cm)
cod.291/ITCPG4P__ (200 cm)
cod.291/ITCPG5P__ (250 cm)

DKK - kr

5.695
7.095
8.495
9.995
5.695
7.095
8.495
9.995
6.995
8.995
11.095
13.095
5.195
6.395
7.595
8.795

Bench legs available colors: 00-06-10-13-14-33-34-42
It is possible to change a seat with a grey metal top
Colori disponibili gambe panca: 00-06-10-13-14-33-34-42
E' possibile sostituire la seduta con un tavolino grigio in metallo

Kalipa



Available colors / Colori disponibili

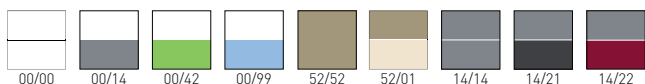

Frame / Telaio
Seat & Back / Seduta e Schienale

KALIPA

Techno-polymer twin-material chair.
Sedia realizzata in tecnopolimero bi-materiale.



CATAS
TESTATO - TESTED

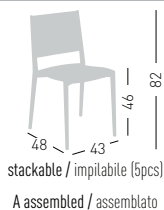

stackable / impilabile (5pcs)
A assembled / assemblato



0,32 m³ - 18,8 kg.
50x65x99cm.
4 pcs [carton]

Frame Finishing & Codes / Finiture Telai e Codici

cod.246.---/A

DKK - kr

995

KALIPA B

Techno-polymer twin-material chair with integrated armrests.
Sedia realizzata in tecnopolimero bi-materiale con braccioli integrati.

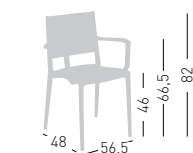

stackable / impilabile (5pcs)
A assembled / assemblato



0,38 m³ - 19,6 kg.
59x65x99cm.
4 pcs [carton]

Frame Finishing & Codes / Finiture Telai e Codici

cod.247.---/A

DKK - kr

1.095

KALIPA CUSHION / CUSCINO

Cushion upholstered with Aurea eco-leather or King fabric.
Cuscino Ecopelle Aurea o tessuto King.



Available fabric.
Tessuti disponibili.

E, K
COM fabric / Tessuto cliente **TC**



0,5 kg
Inside chairs boxes
Inseriti nella scatola delle sedie

Frame Finishing & Codes / Finiture Telai e Codici

cod.306.--
cod.306.TC COM fabric/tessuto cliente

DKK - kr

475
450

Fabric required
Fabbisogno di tessuto
4 pcs: Lin Mtrs 1,0 (h1,40)

COM fabric min. order
10pcs each code
Tessuto cliente TC ordine
min. 10pz per codice

Min. order 4pcs
each code
Ordine min 4pz
per codice

Kanvas



Available colors / Colori disponibili

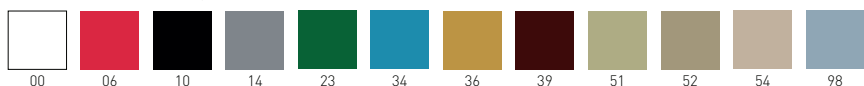

IGN Versions follows UNI 9177 certification in terms of
Fire Resistance, Fire Reaction Class 1
Versioni IGN prodotto Omologato con Classe di Reazione al
fuoco 1, UNI 9177



KANVAS NA



Chromed, black or white painted
4-Legged metal frame, techno-
polymer shell.
Struttura in metallo 4 gambe, cromata,
verniciata nera o bianca, scocca in
tecnopolimero.



CAM ARREDI



only for painted frames
solo per telai verniciati

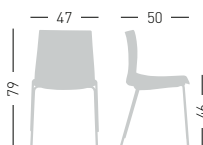

stackable / impilabile (6pcs)
NA not assembled / non assemblato



0,24 m³ - 20 kg.
66x55x63cm.
4 pcs [carton]

Frame Finishing & Codes / Finiture Telai e Codici

cod. 360.--/NA chromed/cromata
cod. 360.--/NAB white painted/verniciato bianco
cod. 360.--/NAN black painted/verniciato nero

DKK - kr

895
1.095
1.095

cod. 360.00/IGNNA
white color, chromed frame, fire retardant/
colore bianco, telaio cromato, ignifuga

1.195

Minimum order 20pcs/ Ordine minimo 20pz

cod. 360.--/IGNNA
chromed frame, fire retardant/
telaio cromato, ignifuga

1.195

Minimum order 300pcs/ Ordine minimo 300pz

KANVAS TB



Chromed or white painted 4-Legged
metal frame with armrests, techno-
polymer shell.
Struttura in metallo 4 gambe con
braccioli, cromata o verniciata bianca,
scocca in tecnopolimero.



only for painted frames
solo per telai verniciati

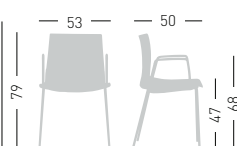

stackable / impilabile (4pcs)
NA not assembled / non assemblato



0,24 m³ - 12,40 kg.
60x55x75cm.
2 pcs [carton]

Frame Finishing & Codes / Finiture Telai e Codici

cod. 360.--/TB chromed/cromata
cod. 360.--/TBB white painted/verniciato bianco

DKK - kr

1.295
1.495

KANVAS S



Chromed, black or white painted wire
steel sled frame, techno-polymer
shell.
Struttura a slitta in filo, cromata,
verniciata nera o bianca, scocca in
tecnopolimero.



only for painted frames
solo per telai verniciati

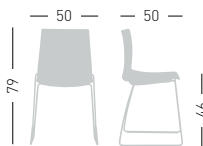

stackable / impilabile (8pcs)
NA not assembled / non assemblato



0,24 m³ - 24,50 kg.
66x55x63cm.
4 pcs [carton]

Frame Finishing & Codes / Finiture Telai e Codici

cod. 360.--/S chromed/cromata
cod. 360.--/SB white painted/verniciato bianco
cod. 360.--/SN black painted/verniciato nero

DKK - kr

895
1.095
1.095

KANVAS ST



Chromed or painted sled steel frame, techno-polymer shell.
Struttura a slitta, cromata o verniciata, scocca in tecnopolimero.



only for painted frames
solo per telai verniciati

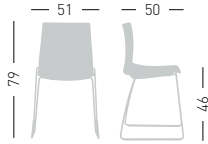

stackable / impilabile (6pcs)

NA not assembled / non assemblato



0,24 m³ - 22 kg.
66x55x63cm.
4 pcs [carton]

Frame Finishing & Codes / Finiture Telai e Codici

cod. 360.--/ST chromed/cromata
cod. 360.--/STB white painted/verniciato bianco
cod. 360.--/STN black painted/verniciato nero

DKK - kr

995
1.095
1.095

KANVAS Z



Chromed "Z" steel frame, stackable, techno-polymer shell.
Struttura in metallo cromato "Z", impilabile, scocca in tecnopolimero.

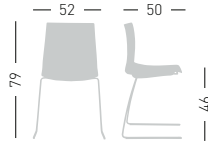

stackable / impilabile (4pcs)

NA not assembled / non assemblato



0,24 m³ - 22 kg.
66x55x63cm.
4 pcs [carton]

Frame Finishing & Codes / Finiture Telai e Codici

cod. 360.--/Z chromed/cromata

DKK - kr

995

KANVAS TC



Chromed or painted wire steel metal frame, techno-polymer shell.
Struttura a traliccio in filo, cromata o verniciata, scocca in tecnopolimero.



only for painted frames
solo per telai verniciati

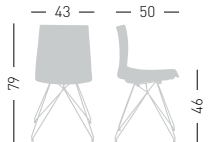

NA not assembled / non assemblato



0,3 m³ - 10 kg.
60x56x51cm



49x49x48cm
2 pcs [carton]

Frame Finishing & Codes / Finiture Telai e Codici

cod. 360.--/TC chromed/cromata
cod. 360.--/TCB white painted/verniciato bianco
cod. 360.--/TCN black painted/verniciato nero

DKK - kr

1.295
1.495
1.495

KANVAS T5R



Swivel on 5-blade polished aluminum base with castors, height adjustable, techno-polymer shell.
Girevole su basamento 5 razze in alluminio pulito con ruote, regolabile in altezza, scocca in tecnopolimero.

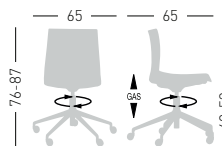

NA not assembled / non assemblato



0,24 m³ - 15,50 kg.
66x55x63cm.
2 pcs [carton]

Frame Finishing & Codes / Finiture Telai e Codici

cod. 360.__/T5R polished/pulita

DKK - kr

2.295

KANVAS T5R BR



Swivel on 5-blade polished aluminum base with castors, height adjustable, techno-polymer shell, armrests.
Girevole su basamento 5 razze in alluminio pulito con ruote, regolabile in altezza, scocca in tecnopolimero, braccioli.

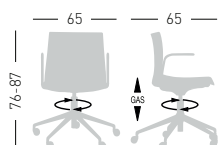

NA not assembled / non assemblato



0,25 m³ - 20 kg.
66x55x63cm.
2 pcs [carton]

Frame Finishing & Codes / Finiture Telai e Codici

cod. 360.___/T5RB polished/pulita

DKK - kr

2.695

Armrests available colors
Colori per braccioli disponibili
00-06-10-14-51-54

KANVAS BL



4-Legged wooden beech frame, techno-polymer shell.
Struttura in legno di faggio 4 gambe, scocca in tecnopolimero.

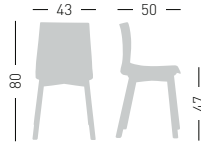

NA not assembled / non assemblato

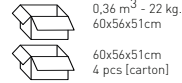

Frame Finishing & Codes / Finiture Telai e Codici

cod. 360.--/BLF

Felt Glides / Tappi in feltro

DKK - kr

2.195

KANVAS TG



Stackable chromed 4 legged frame, aluminum anti-panic joint, scratch resistant tablet, techno-polymer shell.
Struttura impilabile 4 gambe cromata, snodo antipanico in alluminio, tavoletta resistente al graffito, scocca in tecnopolimero.

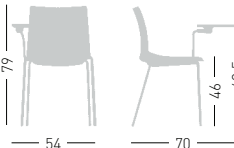

stackable / impilabile (4pcs)

NA not assembled / non assemblato



0,28 m³ - 13,8 kg.
59x53x91cm.
2 pcs [carton]

Frame Finishing & Codes / Finiture Telai e Codici

cod. 360.__/NATG chromed frame/struttura cromata

DKK - kr

2.295

Min. order 20pcs
Ordine min 20pz

KANVAS PG



2-3-4-5 seat benches, metal-polymer co-injected legs, techno-polymer shell.
Panca a 2-3-4-5 posti, gambe co-iniettate in metallo-polimero, scocca in tecnopolimero.

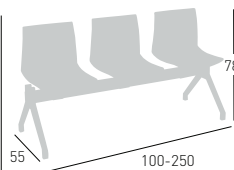

NA not assembled / non assemblato



0,26 m³ - 18 kg.
1 pcs [carton]

0,28 m³ - 23 kg.
1 pcs [carton]

0,38 m³ - 28 kg.
1 pcs [carton]

0,40 m³ - 33 kg.
1 pcs [carton]

Frame Finishing & Codes / Finiture Telai e Codici

cod. 360.--/PG2P-- (100 cm)

cod. 360.--/PG3P-- (150 cm)

cod. 360.--/PG4P-- (200 cm)

cod. 360.--/PG5P-- (250 cm)

DKK - kr

4.095

4.695

5.495

6.095

Bench legs available colors: 00-06-10-13-14-33-34-42
It is possible to change a seat with a grey metal top
Colori disponibili gambe panca: 00-06-10-13-14-33-34-42
E' possibile sostituire la seduta con un tavolino grigio in metallo

KANVAS CUSHION / CUSCINO



Upholstered cushion.
Cuscino tappezzato.

Available fabric.
Tessuti disponibili.
E, K, DK, B
COM fabric / Tessuto cliente TC



0,5 kg
Inside chairs boxes
Inseriti nella scatola delle sedie

Frame Finishing & Codes / Finiture Telai e Codici

cod. 317.-- (E)

cod. 317.-- (K)

cod. 317.-- (DK)

cod. 317.-- (B)

cod. 317.TC COM fabric/tessuto cliente

DKK - kr

575

575

700

650

525

Fabric required
Fabbisogno di tessuto
4 pcs: Lin Mtrs 1,0 (h1,40)

COM fabric min. order
10pcs each code
Tessuto cliente TC ordine
min. 10pz per codice

Min. order 4pcs
each code
Ordine min 4pz
per codice

KANVAS CONNECTING SYSTEM GANCIO CONNESSIONE



Set linking glides for in-line disposal.
Set piedini con agganci per disporre le sedute in linea.



Inside chairs boxes
Nella scatola delle sedie.

Assembled / assemblato

Frame Finishing & Codes / Finiture Telai e Codici

cod. 1012

DKK - kr

125

available for models: S
disponibile per versioni: S

**KANVAS
CHAIRS TROLLEY
CARRELLO PER SEDIE**



Trolley for chairs, chromed metal structure.
Carrello porta sedie, struttura in metallo cromato.

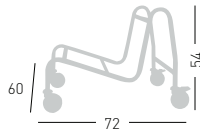

0,3 m³ - 10kg
63x75x58cm.
1 pcs [carton]

Frame Finishing & Codes / Finiture Telai e Codici

cod. 2000/A

available for models: S
disponibile per versioni: S

stackable on trolley 18 pcs
impilabili su carrello 18 pcs

max height with 18 chairs 178 cm
altezza carrello con 18 sedie 178 cm

DKK - kr

2.075

**KANVAS
CHAIRS TROLLEY
CARRELLO PER SEDIE**



Painted grey adjustable Dolly, for 4 legged chairs.
Carrello per sedie 4 gambe, regolabile, verniciato grigio.

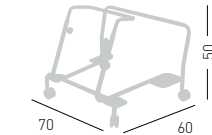

0,3 m³ - 8kg
62x72x51cm.
1 pcs [carton]

Frame Finishing & Codes / Finiture Telai e Codici

cod. 2001/A

available for models: NA
disponibile per versioni: NA

DKK - kr

2.275

**KANVAS
UPHOLSTERED
IMBOTTITE**

Available coverings / Finiture disponibili
Aurea eco-leather / Ecopelle aurea **E** (4pcs min.)
King fabric / Tessuto King **K** (4pcs min.)
Blazer fabric / Tessuto Blazer **B** (4pcs min.)
Kvadrat fabrics / Tessuti Kvadrat **DK** (4pcs min.)
COM fabric / Tessuto cliente **TC** (10pcs min.)

**KANVAS NA
FRONT**



Techno-polymer shell front upholstered, chromed, black or white painted frame.

Scocca in tecnopolimero con frontale rivestito e telaio in metallo verniciato nero o bianco o cromato.

Colours shell / Colori scocca

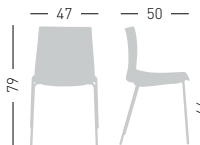
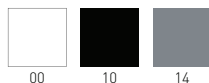

NA not assembled / non assemblato

0,48 m³ - 24,8 kg.
66x55x63cm
4 pcs [carton]

Frame Finishing & Codes / Finiture Telai e Codici

cod. 361. _ _ / IENA chromed/cromata

cod. 361. _ _ / IENAN black painted/verniciato nero

cod. 361. _ _ / IENAB white painted/verniciato bianco

cod. 361. _ _ / IKNA chromed/cromata

cod. 361. _ _ / IKNAN black painted/verniciato nero

cod. 361. _ _ / IKNAB white painted/verniciato bianco

cod. 361. _ _ / IBNA chromed/cromata

cod. 361. _ _ / IBNAN black painted/verniciato nero

cod. 361. _ _ / IBNAB white painted/verniciato bianco

cod. 361. _ _ / IDKNA chromed/cromata

cod. 361. _ _ / IDKNAN black painted/verniciato nero

cod. 361. _ _ / IDKNAB white painted/verniciato bianco

cod. 361. _ _ / ITCNA chromed/cromata

cod. 361. _ _ / ITCNAN black painted/verniciato nero

cod. 361. _ _ / ITCNAB white painted/verniciato bianco

DKK - kr

1.895

2.095

2.095

1.895

2.095

2.095

1.995

2.195

2.195

2.295

2.495

2.495

1.795

1.895

1.895

Fabric required
Fabbisogno di tessuto
1 pcs: Lin Mtrs 0,6 (h1,40)

COM fabric min. order
10pcs each code
Tessuto cliente TC ordine
min. 10pz per codice

Min. order 4pcs
each code
Ordine min 4pz
per codice

KANVAS TB FRONT



Techno-polymer shell front upholstered, chromed or painted frame.
Scocca in tecnopolimero con frontale rivestito e telaio in metallo verniciato o cromato.

Colours shell / Colori scocca

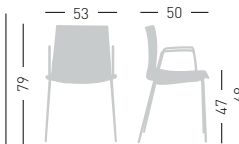
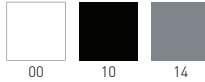

NA not assembled / non assemblato



0,29 m³ - 14,5 kg.
59x53x91cm.
2 pcs [carton]

Frame Finishing & Codes / Finiture Telai e Codici

cod. 361. __-_/IETB chromed/cromata
cod. 361. __-_/IETBB white painted/verniciato bianco
cod. 361. __-_/IKTB chromed/cromata
cod. 361. __-_/IKTBB white painted/verniciato bianco
cod. 361. __-_/IBTB chromed/cromata
cod. 361. __-_/IBTBB white painted/verniciato bianco
cod. 361. __-_/IDKTB chromed/cromata
cod. 361. __-_/IDKTBB white painted/verniciato bianco
cod. 361. __/ITCTB chromed/cromata
cod. 361. __/ITCTBB white painted/verniciato bianco

DKK - kr

2.195
2.395
2.195
2.395
2.295
2.495
2.595
2.795
1.995
2.195

Fabric required
Fabbisogno di tessuto
1 pcs: Lin Mtrs 0,6 (h1,40)

COM fabric min. order
10pcs each code
Tessuto cliente TC ordine
min. 10pz per codice

Min. order 4pcs
each code
Ordine min 4pz
per codice

KANVAS S FRONT



Techno-polymer shell front upholstered, chromed, black or white painted frame.
Scocca in tecnopolimero con frontale rivestito e telaio in metallo cromato, verniciato nero o bianco.

Colours shell / Colori scocca

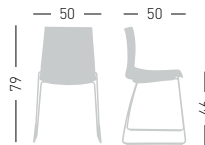
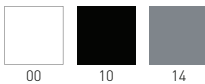

NA not assembled / non assemblato



0,48 m³ - 30 kg.
66x55x63cm



66x55x63cm
4 pcs [carton]

Frame Finishing & Codes / Finiture Telai e Codici

cod. 361. __-_/IES chromed/cromata
cod. 361. __-_/IESB white painted/verniciato bianco
cod. 361. __-_/IESN black painted/verniciato nero
cod. 361. __-_/IKS chromed/cromata
cod. 361. __-_/IKSB white painted/verniciato bianco
cod. 361. __-_/IKSN black painted/verniciato nero
cod. 361. __-_/IBS chromed/cromata
cod. 361. __-_/IBSB white painted/verniciato bianco
cod. 361. __-_/IBSN black painted/verniciato nero
cod. 361. __-_/IDKS chromed/cromata
cod. 361. __-_/IDKSB white painted/verniciato bianco
cod. 361. __-_/IDKSN black painted/verniciato nero
cod. 361. __/ITCS chromed/cromata
cod. 361. __/ITCSB white painted/verniciato bianco
cod. 361. __/ITCSN black painted/verniciato nero

DKK - kr

1.895
2.095
2.095
1.895
2.095
2.095
1.995
2.195
2.195
2.295
2.495
2.495
1.795
1.895
1.895

Fabric required
Fabbisogno di tessuto
1 pcs: Lin Mtrs 0,6 (h1,40)

COM fabric min. order
10pcs each code
Tessuto cliente TC ordine
min. 10pz per codice

Min. order 4pcs
each code
Ordine min 4pz
per codice

KANVAS ST FRONT



Techno-polymer shell front upholstered, chromed or painted frame.
Scocca in tecnopolimero con frontale rivestito e telaio in metallo verniciato o cromato.

Colours shell / Colori scocca

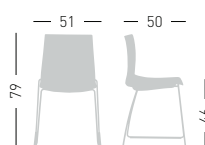

NA not assembled / non assemblato



0,48 m³ - 27 kg.
66x55x63cm



66x55x63cm
4 pcs [carton]

Frame Finishing & Codes / Finiture Telai e Codici

cod. 361. __-_/IEST chromed/cromata
cod. 361. __-_/IESTB white painted/verniciato bianco
cod. 361. __-_/IESTN black painted/verniciato nero
cod. 361. __-_/IKST chromed/cromata
cod. 361. __-_/IKSTB white painted/verniciato bianco
cod. 361. __-_/IKSTN black painted/verniciato nero
cod. 361. __-_/IBST chromed/cromata
cod. 361. __-_/IBSTB white painted/verniciato bianco
cod. 361. __-_/IBSTN black painted/verniciato nero
cod. 361. __-_/IDKST chromed/cromata
cod. 361. __-_/IDKSTB white painted/verniciato bianco
cod. 361. __-_/IDKSTN black painted/verniciato nero
cod. 361. __/ITCST chromed/cromata
cod. 361. __/ITCSTB white painted/verniciato bianco
cod. 361. __/ITCSTN black painted/verniciato nero

DKK - kr

1.995
2.095
2.095
1.995
2.095
2.095
2.095
2.295
2.295
2.395
2.495
2.495
1.795
1.995
1.995

Fabric required
Fabbisogno di tessuto
1 pcs: Lin Mtrs 0,6 (h1,40)

COM fabric min. order
10pcs each code
Tessuto cliente TC ordine
min. 10pz per codice

Min. order 4pcs
each code
Ordine min 4pz
per codice

KANVAS Z FRONT



Chromed "Z" steel frame, techno-polymer shell front upholstered.
Struttura in metallo cromato "Z", scocca in tecnopolimero con frontale rivestito.

Colours shell / Colori scocca

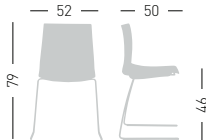
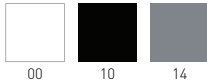

NA not assembled / non assemblato

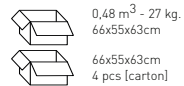

Frame Finishing & Codes / Finiture Telai e Codici

cod. 361. __ /IEZ chromed/cromata
cod. 361. __ /IKZ chromed/cromata
cod. 361. __ /IBZ chromed/cromata
cod. 361. __ /IDKZ chromed/cromata
cod. 361. __ /ITCZ chromed/cromata

DKK - kr

1.995
1.995
2.195
2.495
1.895

Fabric required
Fabbisogno di tessuto
1 pcs: Lin Mtrs 0,6 (h1,40)

COM fabric min. order
10pcs each code
Tessuto cliente TC ordine
min. 10pz per codice

Min. order 4pcs
each code
Ordine min 4pz
per codice

KANVAS TC FRONT



Techno-polymer shell front upholstered, chromed or painted frame.
Scocca in tecnopolimero con frontale rivestito e telaio in metallo verniciato o cromato.

Colours shell / Colori scocca

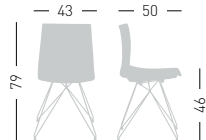
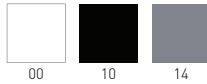

NA not assembled / non assemblato

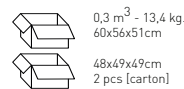

Frame Finishing & Codes / Finiture Telai e Codici

cod. 361. __ /IETC chromed/cromata
cod. 361. __ /IETCB white painted/verniciato bianco
cod. 361. __ /IETCN black painted/verniciato nero
cod. 361. __ /IKTC chromed/cromata
cod. 361. __ /IKTCB white painted/verniciato bianco
cod. 361. __ /IKTCN black painted/verniciato nero
cod. 361. __ /IBTC chromed/cromata
cod. 361. __ /IBTCB white painted/verniciato bianco
cod. 361. __ /IBTCN black painted/verniciato nero
cod. 361. __ /IDKTC chromed/cromata
cod. 361. __ /IDKTCB white painted/verniciato bianco
cod. 361. __ /IDKTCN black painted/verniciato nero
cod. 361. __ /ITCTC chromed/cromata
cod. 361. __ /ITCTCB white painted/verniciato bianco
cod. 361. __ /ITCTCN black painted/verniciato nero

DKK - kr

2.095
2.195
2.195
2.095
2.195
2.195
2.395
2.395
2.495
2.695
2.695
1.995
2.095
2.095

Fabric required
Fabbisogno di tessuto
1 pcs: Lin Mtrs 0,6 (h1,40)

COM fabric min. order
10pcs each code
Tessuto cliente TC ordine
min. 10pz per codice

Min. order 4pcs
each code
Ordine min 4pz
per codice

KANVAS T5R FRONT



Swivel on 5-blade polished aluminum base with castors, height adjustable, techno-polymer shell front upholstered.
Girevole su base a 5 razze in alluminio pulito con ruote, regolabile in altezza, scocca in tecnopolimero con frontale rivestito.

Colours shell / Colori scocca

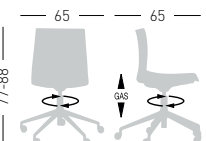

NA not assembled / non assemblato

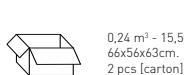

Frame Finishing & Codes / Finiture Telai e Codici

cod. 361. __ /IET5R polished/pulita
cod. 361. __ /IKT5R polished/pulita
cod. 361. __ /IBT5R polished/pulita
cod. 361. __ /IDKT5R polished/pulita
cod. 361. __ /ITCT5R polished/pulita

DKK - kr

3.095
3.095
3.195
3.495
2.995

Fabric required
Fabbisogno di tessuto
1 pcs: Lin Mtrs 0,6 (h1,40)

COM fabric min. order
10pcs each code
Tessuto cliente TC ordine
min. 10pz per codice

Min. order 4pcs
each code
Ordine min 4pz
per codice

KANVAS T5R BR FRONT



Swivel on 5-blade polished aluminum base with castors, height adjustable, techno-polymer shell front upholstered, with armrests.
Girevole su base a 5 razze in alluminio pulito con ruote, regolabile in altezza, scocca in tecnopolimero con frontale rivestito e braccioli.

Armrests and shell's colours are combined.
Il colore dei braccioli è abbinato alla scocca.

Colours shell / Colori scocca

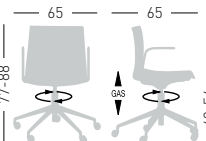
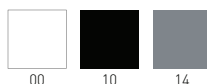

NA not assembled / non assemblato



Frame Finishing & Codes / Finiture Telai e Codici

cod. 361. __ /IET5RB polished/pulita
cod. 361. __ /IKT5RB polished/pulita
cod. 361. __ /IBT5RB polished/pulita
cod. 361. __ /IDKT5RB polished/pulita
cod. 361. __ /ITCT5RB polished/pulita

DKK - kr

3.495
3.495
3.595
3.895
3.395

Fabric required
Fabbisogno di tessuto
1 pcs: Lin Mtrs 0,6 (h1,40)

COM fabric min. order
10pcs each code
Tessuto cliente TC ordine
min. 10pz per codice

Min. order 4pcs
each code
Ordine min 4pz
per codice

KANVAS BL FRONT



Techno-polymer shell front upholstered, beech wooden frame.
Scocca in tecnopolimero con frontale rivestito e base in legno di faggio.

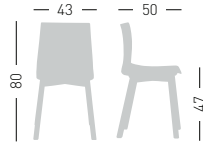

NA not assembled / non assemblato

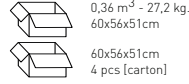

Colours shell / Colori scocca

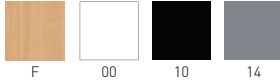

Frame Finishing & Codes / Finiture Telai e Codici

cod. 361. __-__ /IEBLF
cod. 361. __-__ /IKBLF
cod. 361. __-__ /IBBLF
cod. 361. __-__ /IDKBLF
cod. 361. __-__ /ITCBLF

DKK - kr

2.995
2.995
3.295
3.395
2.895

Felt Glides / Tappi in feltro

Fabric required
Fabbisogno di tessuto
1 pcs: Lin Mtrs 0,6 (h1,40)

COM fabric min. order
10pcs each code
Tessuto cliente TC ordine
min. 10pz per codice

Min. order 4pcs
each code
Ordine min 4pz
per codice

KANVAS PG FRONT



Techno-polymer shell front upholstered, frame beam in painted metal and polymer-metal legs.
Scocca in tecnopolimero con frontale rivestito, trave panca in metallo verniciato e gambe in polimero-metallo co-iniettati.

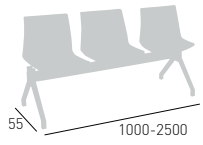

NA not assembled / non assemblato



(100cm)
0,24 m³ - 24 kg.
66x55x63cm.
1 pcs [carton]

(150cm)
0,24 m³ - 29 kg.
66x55x63cm.
1 pcs [carton]

(200cm)
0,36 m³ - 36 kg.
60x56x51x2cm.
1 pcs [carton]

(250cm)
0,36 m³ - 43 kg.
60x56x51x2cm.
1 pcs [carton]

Colours shell / Colori scocca

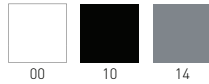

Frame Finishing & Codes / Finiture Telai e Codici

cod. 361. __-__ /IEPG2P-- (100 cm)
cod. 361. __-__ /IEPG3P-- (150 cm)
cod. 361. __-__ /IEPG4P-- (200 cm)
cod. 361. __-__ /IEPG5P-- (250 cm)
cod. 361. __-__ /IKPG2P-- (100 cm)
cod. 361. __-__ /IKPG3P-- (150 cm)
cod. 361. __-__ /IKPG4P-- (200 cm)
cod. 361. __-__ /IKPG5P-- (250 cm)
cod. 361. __-__ /IBPG2P-- (100 cm)
cod. 361. __-__ /IBPG3P-- (150 cm)
cod. 361. __-__ /IBPG4P-- (200 cm)
cod. 361. __-__ /IBPG5P-- (250 cm)
cod. 361. __-__ /IDKPG2P-- (100 cm)
cod. 361. __-__ /IDKPG3P-- (150 cm)
cod. 361. __-__ /IDKPG4P-- (200 cm)
cod. 361. __-__ /IDKPG5P-- (250 cm)
cod. 361. __-__ /ITCPG2P-- (100 cm)
cod. 361. __-__ /ITCPG3P-- (150 cm)
cod. 361. __-__ /ITCPG4P-- (200 cm)
cod. 361. __-__ /ITCPG5P-- (250 cm)

DKK - kr

5.595
6.995
8.695
9.995
5.595
6.995
8.695
9.995
5.895
7.395
8.295
10.695
6.495
8.195
10.395
12.095
5.395
6.595
8.195
9.395

Bench legs available colors: 00-06-10-13-14-33-34-42
It is possible to change a seat with a grey metal top
Colori disponibili gambe panca: 00-06-10-13-14-33-34-42
E' possibile sostituire la seduta con un tavolino grigio in metallo

Fabric required
Fabbisogno di tessuto
1 pcs: Lin Mtrs 1 (h1,40)

KANVAS NA FULL



Techno-polymer upholstered shell and chromed or painted frame.
Scocca in tecnopolimero rivestita e telaio in metallo verniciato o cromato.

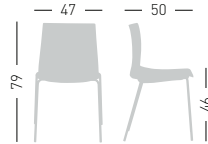

NA not assembled / non assemblato

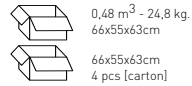

Frame Finishing & Codes / Finiture Telai e Codici

cod. 360.--/IENA chromed/cromata
cod. 360.--/IENAB white painted/verniciato bianco
cod. 360.--/IENAN black painted/verniciato nero
cod. 360.--/IKNA chromed/cromata
cod. 360.--/IKNAB white painted/verniciato bianco
cod. 360.--/IKNAN black painted/verniciato nero
cod. 360.--/IBNA chromed/cromata
cod. 360.--/IBNAB white painted/verniciato bianco
cod. 360.--/IBNAN black painted/verniciato nero
cod. 360.--/IDKNA chromed/cromata
cod. 360.--/IDKNAB white painted/verniciato bianco
cod. 360.--/IDKNAN black painted/verniciato nero
cod. 360/ITCNA chromed/cromata
cod. 360/ITCNAB white painted/verniciato bianco
cod. 360/ITCNAN black painted/verniciato nero

DKK - kr

2.695
2.795
2.795
2.695
2.795
2.795
2.795
2.895
2.895
3.395
3.495
3.495
2.395
2.495
2.495

Fabric required
Fabbisogno di tessuto
1 pcs: Lin Mtrs 1 (h1,40)

COM fabric min. order
10pcs each code
Tessuto cliente TC ordine
min. 10pz per codice

Min. order 4pcs
each code
Ordine min 4pz
per codice

KANVAS TB FULL



Techno-polymer upholstered shell and chromed or painted frame.
Scocca in tecnopolimero rivestita e telaio in metallo verniciato o cromato.

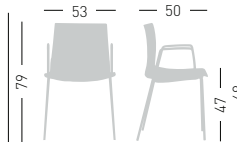

NA not assembled / non assemblato

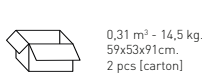

Frame Finishing & Codes / Finiture Telai e Codici

cod. 360.--/IETB chromed/cromata
cod. 360.--/IETBB white painted/verniciato bianco
cod. 360.--/IKTB chromed/cromata
cod. 360.--/IKTBB white painted/verniciato bianco
cod. 360.--/IBTB chromed/cromata
cod. 360.--/IBTBB white painted/verniciato bianco
cod. 360.--/IDKTB chromed/cromata
cod. 360.--/IDKTB white painted/verniciato bianco
cod. 360/ITCTB chromed/cromata
cod. 360/ITCTBB white painted/verniciato bianco

DKK - kr

2.895
3.195
2.895
3.195
3.095
3.295
3.595
3.895
2.695
2.895

Fabric required
Fabbisogno di tessuto
1 pcs: Lin Mtrs 1 (h1,40)

COM fabric min. order
10pcs each code
Tessuto cliente TC ordine
min. 10pz per codice

Min. order 4pcs
each code
Ordine min 4pz
per codice

KANVAS S FULL



Techno-polymer upholstered shell and chromed or painted frame.
Scocca in tecnopolimero rivestita e telaio in metallo verniciato o cromato.

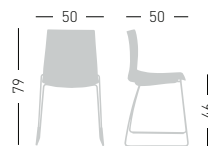

NA not assembled / non assemblato

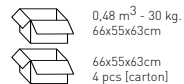

Frame Finishing & Codes / Finiture Telai e Codici

cod. 360.--/IES chromed/cromata
cod. 360.--/IESB white painted/verniciato bianco
cod. 360.--/IESN black painted/verniciato nero
cod. 360.--/IKS chromed/cromata
cod. 360.--/IKSB white painted/verniciato bianco
cod. 360.--/IKSN black painted/verniciato nero
cod. 360.--/IBS chromed/cromata
cod. 360.--/IBSB white painted/verniciato bianco
cod. 360.--/IBSN black painted/verniciato nero
cod. 360.--/IDKS chromed/cromata
cod. 360.--/IDKSB white painted/verniciato bianco
cod. 360.--/IDKSN black painted/verniciato nero
cod. 360/ITCS chromed/cromata
cod. 360/ITCSB white painted/verniciato bianco
cod. 360/ITCSN black painted/verniciato nero

DKK - kr

2.695
2.795
2.795
2.695
2.795
2.795
2.795
2.895
2.895
3.395
3.495
3.495
2.395
2.495
2.495

Fabric required
Fabbisogno di tessuto
1 pcs: Lin Mtrs 1 (h1,40)

COM fabric min. order
10pcs each code
Tessuto cliente TC ordine
min. 10pz per codice

Min. order 4pcs
each code
Ordine min 4pz
per codice

KANVAS ST FULL



Techno-polymer upholstered shell and chromed or painted frame. Scocca in tecnopolimero rivestita e telaio in metallo verniciato o cromato.

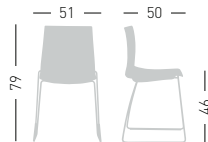

NA not assembled / non assemblato

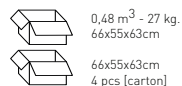

Frame Finishing & Codes / Finiture Telai e Codici

cod. 360.--/IEST chromed/cromata	DKK - kr	2.695
cod. 360.--/IESTB white painted/verniciato bianco		2.895
cod. 360.--/IESTN black painted/verniciato nero		2.895
cod. 360.--/IKST chromed/cromata		2.695
cod. 360.--/IKSTB white painted/verniciato bianco		2.895
cod. 360.--/IKSTN black painted/verniciato nero		2.895
cod. 360.--/IBST chromed/cromata		2.895
cod. 360.--/IBSTB white painted/verniciato bianco		2.995
cod. 360.--/IBSTN black painted/verniciato nero		2.995
cod. 360.--/IDKST chromed/cromata		3.395
cod. 360.--/IDKSTB white painted/verniciato bianco		3.595
cod. 360.--/IDKSTN black painted/verniciato nero		3.595
cod. 360/ITCST chromed/cromata		2.495
cod. 360/ITCSTB white painted/verniciato bianco		2.595
cod. 360/ITCSTN black painted/verniciato nero		2.595

Fabric required
Fabbisogno di tessuto
1 pcs: Lin Mtrs 1 (h1,40)

COM fabric min. order
10pcs each code
Tessuto cliente TC ordine
min. 10pz per codice

Min. order 4pcs
each code
Ordine min 4pz
per codice

KANVAS Z FULL



Chromed "Z" steel frame, techno-polymer upholstered shell. Struttura in metallo cromato "Z", scocca in tecnopolimero rivestito.

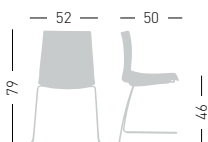

NA not assembled / non assemblato



Frame Finishing & Codes / Finiture Telai e Codici

cod. 360.--/IEZ chromed/cromata	DKK - kr	2.795
cod. 360.--/IKZ chromed/cromata		2.895
cod. 360.--/IBZ chromed/cromata		3.495
cod. 360.--/IDKZ chromed/cromata		2.495
cod. 360/ITCZ chromed/cromata		2.495

Fabric required
Fabbisogno di tessuto
1 pcs: Lin Mtrs 1 (h1,40)

COM fabric min. order
10pcs each code
Tessuto cliente TC ordine
min. 10pz per codice

Min. order 4pcs
each code
Ordine min 4pz
per codice

KANVAS TC FULL



Techno-polymer upholstered shell and chromed or painted frame. Scocca in tecnopolimero rivestita e telaio in metallo verniciato o cromato.

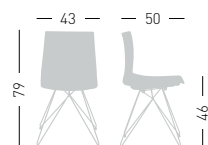

NA not assembled / non assemblato

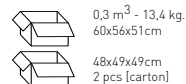

Frame Finishing & Codes / Finiture Telai e Codici

cod. 360.--/IETC chromed/cromata	DKK - kr	2.795
cod. 360.--/IETCB white painted/verniciato bianco		2.995
cod. 360.--/IETCN black painted/verniciato nero		2.995
cod. 360.--/IKTC chromed/cromata		2.795
cod. 360.--/IKTCB white painted/verniciato bianco		2.995
cod. 360.--/IKTCN black painted/verniciato nero		2.995
cod. 360.--/IBTC chromed/cromata		2.995
cod. 360.--/IBTCB white painted/verniciato bianco		3.095
cod. 360.--/IBTCN black painted/verniciato nero		3.095
cod. 360.--/IDKTC chromed/cromata		3.495
cod. 360.--/IDKTCB white painted/verniciato bianco		3.695
cod. 360.--/IDKTCN black painted/verniciato nero		3.695
cod. 360/ITCTC chromed/cromata		2.595
cod. 360/ITCTCB white painted/verniciato bianco		2.695
cod. 360/ITCTCN black painted/verniciato nero		2.695

Fabric required
Fabbisogno di tessuto
1 pcs: Lin Mtrs 1 (h1,40)

COM fabric min. order
10pcs each code
Tessuto cliente TC ordine
min. 10pz per codice

Min. order 4pcs
each code
Ordine min 4pz
per codice

KANVAS T5R FULL



Swivel on 5-blade polished aluminum base with castors, height adjustable, techno-polymer shell full upholstered.

Girevole su base a 5 razze in alluminio pulito con ruote, regolabile in altezza, scocca in tecnopolimero rivestita.

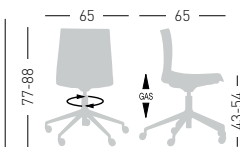

NA not assembled / non assemblato

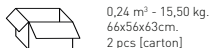

Frame Finishing & Codes / Finiture Telai e Codici

cod. 360. __/IET5R polished/pulita
 cod. 360. __/IKT5R polished/pulita
 cod. 360. __/IBT5R polished/pulita
 cod. 360. __/IDKT5R polished/pulita
 cod. 360./ITCT5R polished/pulita

DKK - kr

3.895
 3.895
 3.995
 4.595
 3.595

Fabric required
 Fabbisogno di tessuto
 1 pcs: Lin Mtrs 1 (h1,40)

COM fabric min. order
 10pcs each code
 Tessuto cliente TC ordine
 min. 10pz per codice

Min. order 4pcs
 each code
 Ordine min 4pz
 per codice

KANVAS T5R BR FULL



Swivel on 5-blade polished aluminum base with castors, height adjustable, techno-polymer shell full upholstered, with armrests.

Girevole su base a 5 razze in alluminio pulito con ruote, regolabile in altezza, scocca in tecnopolimero rivestita e braccioli.

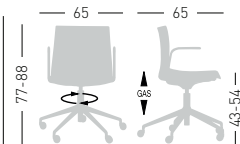

NA not assembled / non assemblato

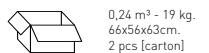

Frame Finishing & Codes / Finiture Telai e Codici

cod. 360. __-_/IET5RB polished/pulita
 cod. 360. __-_/IKT5RB polished/pulita
 cod. 360. __-_/IBT5RB polished/pulita
 cod. 360. __-_/IDKT5RB polished/pulita
 cod. 360. __/ITCT5RB polished/pulita

DKK - kr

4.195
 4.195
 4.395
 4.995
 3.995

Fabric required
 Fabbisogno di tessuto
 1 pcs: Lin Mtrs 1 (h1,40)

COM fabric min. order
 10pcs each code
 Tessuto cliente TC ordine
 min. 10pz per codice

Min. order 4pcs
 each code
 Ordine min 4pz
 per codice

Armrests available colors
 Colori per braccioli disponibili
 00-06-10-14-51-54

KANVAS BL FULL



Techno-polymer upholstered shell and beech wood frame.

Scocca in tecnopolimero rivestita e base in legno di faggio.

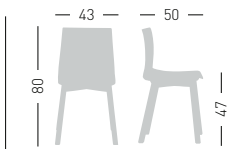

NA not assembled / non assemblato

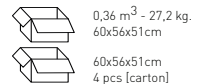

Frame Finishing & Codes / Finiture Telai e Codici

cod. 360.--/IEBLF
 cod. 360.--/IKBLF
 cod. 360.--/IBBLF
 cod. 360.--/IDKBLF
 cod. 360./ITCBLF

DKK - kr

3.795
 3.795
 3.895
 4.495
 3.495

Felt Glides / Tappi in feltro

Fabric required
 Fabbisogno di tessuto
 1 pcs: Lin Mtrs 1 (h1,40)

COM fabric min. order
 10pcs each code
 Tessuto cliente TC ordine
 min. 10pz per codice

Min. order 4pcs
 each code
 Ordine min 4pz
 per codice



KANVAS PG FULL



Techno-polymer upholstered shell, frame beam in painted metal and techno-polymer legs.

Scocca rivestita, trave panca in metallo verniciato e gambe in polimero-metallo co-iniettati.

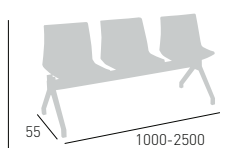

NA not assembled / non assemblato

Frame Finishing & Codes / Finiture Telai e Codici

(100cm)
 0,24 m³ - 24 kg.
 66x55x63cm.
 1 pcs [carton]
 (150cm)
 0,24 m³ - 29 kg.
 66x55x63cm.
 1 pcs [carton]
 (200cm)
 0,36 m³ - 36 kg.
 60x56x51x2cm.
 1 pcs [carton]
 (250cm)
 0,36 m³ - 43 kg.
 60x56x51x2cm.
 1 pcs [carton]

cod. 360.--/IEPG2P-- (100 cm)
 cod. 360.--/IEPG3P-- (150 cm)
 cod. 360.--/IEPG4P-- (200 cm)
 cod. 360.--/IEPG5P-- (250 cm)
 cod. 360.--/IKPG2P-- (100 cm)
 cod. 360.--/IKPG3P-- (150 cm)
 cod. 360.--/IKPG4P-- (200 cm)
 cod. 360.--/IKPG5P-- (250 cm)
 cod. 360.--/IBPG2P-- (100 cm)
 cod. 360.--/IBPG3P-- (150 cm)
 cod. 360.--/IBPG4P-- (200 cm)
 cod. 360.--/IBPG5P-- (250 cm)
 cod. 360.--/IDKPG2P-- (100 cm)
 cod. 360.--/IDKPG3P-- (150 cm)
 cod. 360.--/IDKPG4P-- (200 cm)
 cod. 360.--/IDKPG5P-- (250 cm)
 cod. 360./ITCPG2P-- (100 cm)
 cod. 360./ITCPG3P-- (150 cm)
 cod. 360./ITCPG4P-- (200 cm)
 cod. 360./ITCPG5P-- (250 cm)

DKK - kr

7.095
 9.195
 11.695
 13.795

7.095
 9.195
 11.695
 13.795

7.395
 9.595
 12.195
 14.395

8.495
 11.295
 14.495
 17.295

6.595
 8.395
 10.595
 12.495

Bench legs available colors: 00-06-10-13-14-33-34-42
 It is possible to change a seat with a grey metal top
 Colori disponibili gambe panca: 00-06-10-13-14-33-34-42
 E' possibile sostituire la seduta con un tavolino grigio in metallo

Fabric required
 Fabbisogno di tessuto
 1 pcs: Lin Mtrs 1 (h1,40)

Kanvas 2



Available colors / Colori disponibili

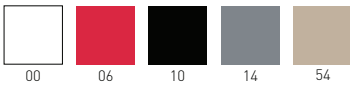

IGN Versions follows UNI 9177 certification in terms of Fire Resistance, Fire Reaction Class 1
Versioni IGN prodotto Omologato con Classe di Reazione al fuoco 1, UNI 9177



KANVAS 2 NA



Chromed or white painted 4-Legged metal frame, techno-polymer shell.
Struttura in metallo 4 gambe, cromata o verniciata bianca, scocca in tecnopolimero.



only for painted frames
solo per telai verniciati

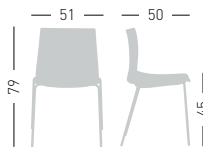

stackable / impilabile (6pcs)
NA not assembled / non assemblato

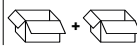

0,42 m³ - 27,2 kg.
60x56x51cm.
66x55x63cm.
4 pcs [carton]

Frame Finishing & Codes / Finiture Telai e Codici

cod. 365.__/NA chromed/cromata
cod. 365.__/NAB white painted/verniciato bianco

DKK - kr

1.195
1.295

cod. 365.__/IGNNA
chromed frame, fire retardant/
telai cromato, ignifuga

Minimum order 300pcs/ Ordine minimo 300pz

1.495

KANVAS 2 ST



Chromed or white painted sled steel frame, techno-polymer shell.
Struttura a slitta, cromata o verniciata bianca, scocca in tecnopolimero.



only for painted frames
solo per telai verniciati

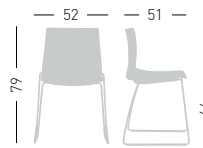

stackable / impilabile (6pcs)
NA not assembled / non assemblato

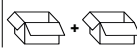

0,42 m³ - 30 kg.
60x56x51cm.
59x53x91cm.
4 pcs [carton]

Frame Finishing & Codes / Finiture Telai e Codici

cod. 365.__/ST chromed/cromata
cod. 365.__/STB white painted/verniciato bianco

DKK - kr

1.295
1.395

KANVAS 2 STS



Chromed or white painted sled frame with armrests, techno-polymer shell. Struttura a slitta con braccioli, cromata o verniciata bianca, scocca in tecnopolimero.



only for paintend frames
solo per telai verniciati

Armrests and shell's colours are combined.
Il colore dei braccioli è abbinato alla scocca.

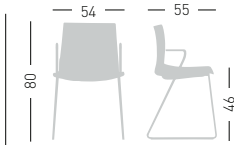

stackable / impilabile (6pcs)
NA not assembled / non assemblato

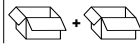

0,56 m³ - 32 kg.
60x56x51cm.
57x63x97cm.
4 pcs [carton]

Frame Finishing & Codes / Finiture Telai e Codici

cod. 365. __- __/STS chromed/cromata
cod. 365. __- __/STSB white painted/verniciato bianco

DKK - kr

1.595
1.795

KANVAS 2 CTLS



Chromed or white painted cantilevered frame with armrests, techno-polymer shell. Struttura a slitta con braccioli, cromata o verniciata bianca, scocca in tecnopolimero.



only for paintend frames
solo per telai verniciati

Armrests and shell's colours are combined.
Il colore dei braccioli è abbinato alla scocca.

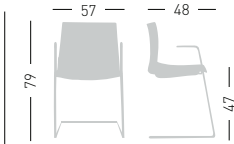

stackable / impilabile (2pcs)
NA not assembled / non assemblato

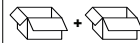

0,56 m³ - 40 kg.
60x56x51cm.
57x63x97cm.
4 pcs [carton]

Frame Finishing & Codes / Finiture Telai e Codici

cod. 365. __- __/CTLS chromed/cromata
cod. 365. __- __/CTLSB white painted/verniciato bianco

DKK - kr

1.695
1.795

KANVAS 2 BL



4-Legged wooden beech frame, techno-polymer shell. Struttura in legno di faggio 4 gambe, scocca in tecnopolimero.



F

Armrests and shell's colours are combined.
Il colore dei braccioli è abbinato alla scocca.

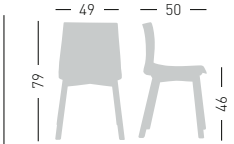

NA not assembled / non assemblato

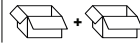

0,36 m³ - 36 kg.
60x56x51cm.
60x56x51cm.
4 pcs [carton]

Frame Finishing & Codes / Finiture Telai e Codici

cod. 365. __/BLF
Felt Glides / Tappi in feltro

DKK - kr

2.395

KANVAS 2 T5R



Swivel on 5-blade polished aluminum base with castors, height adjustable, techno-polymer shell. Girevole su basamento 5 razze in alluminio pulito con ruote, regolabile in altezza, scocca in tecnopolimero.

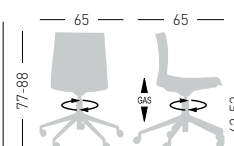

NA not assembled / non assemblato

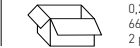

0,24 m³ - 17 kg.
66x55x63cm.
2 pcs [carton]

Frame Finishing & Codes / Finiture Telai e Codici

cod. 365. __/T5R polished/pulita

DKK - kr

2.595

KANVAS 2 T5R BR



Swivel on 5-blade polished aluminum base with castors, height adjustable, techno-polymer shell, armrests. Girevole su basamento 5 razze in alluminio pulito con ruote, regolabile in altezza, scocca in tecnopolimero, braccioli.

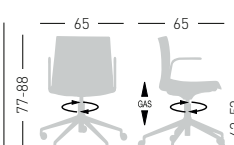

NA not assembled / non assemblato



0,24 m³ - 20 kg.
66x55x63cm.
2 pcs [carton]

Frame Finishing & Codes / Finiture Telai e Codici

cod. 365. __- __/T5RB polished/pulita

DKK - kr

2.995

Armrests and shell's colours are combined.
Il colore dei braccioli è abbinato alla scocca.

KANVAS 2 U



Techno-polymer shell, swivel on 4-blade aluminum painted base. Scocca in tecnopolimero, girevole su basamento verniciato in alluminio a 4 razze.

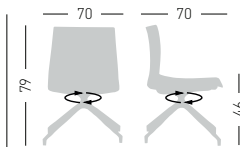

NA not assembled / non assemblato

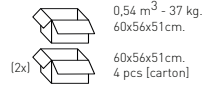

Frame Finishing & Codes / Finiture Telai e Codici

cod. 365.__/UB white/bianca
cod. 365.__/UN black/nera

Felt Glides / Tappi in feltro

DKK - kr

2.395
2.395

KANVAS 2 U BR



Techno-polymer shell, swivel on 4-blade aluminum painted base, armrests. Scocca in tecnopolimero, girevole su basamento verniciato in alluminio a 4 razze, braccioli.

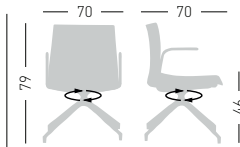

NA not assembled / non assemblato

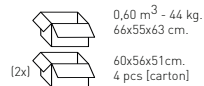

Frame Finishing & Codes / Finiture Telai e Codici

cod. 365.__-__/UBB white/bianca
cod. 365.__-__/UNB black/nera

Felt Glides / Tappi in feltro

DKK - kr

2.795
2.795

Armrests and shell's colours are combined. Il colore dei braccioli è abbinato alla scocca.

KANVAS 2 UR



Techno-polymer shell, swivel on 4-blade aluminum painted base, with castors. Scocca in tecnopolimero, girevole su basamento verniciato in alluminio a 4 razze, su ruote.

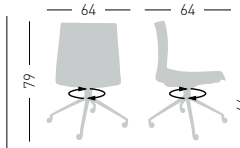

NA not assembled / non assemblato

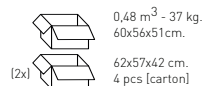

Frame Finishing & Codes / Finiture Telai e Codici

cod. 365.__/URB white/bianca
cod. 365.__/URN black/nera

DKK - kr

2.395
2.395

KANVAS 2 UR BR



Techno-polymer shell, swivel on 4-blade aluminum painted base, with castors and armrests. Scocca in tecnopolimero, girevole su basamento verniciato in alluminio a 4 razze su ruote, braccioli.

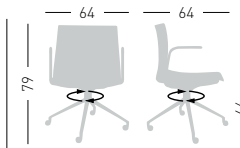

NA not assembled / non assemblato



Frame Finishing & Codes / Finiture Telai e Codici

cod. 365.__-__/URBB white/bianca
cod. 365.__-__/URNB black/nera

DKK - kr

2.795
2.795

Armrests and shell's colours are combined. Il colore dei braccioli è abbinato alla scocca.

KANVAS 2 O5R COACH



Swivel on 5-blade painted or polished aluminum base with castors, height adjustable, technopolymer shell, rotating tablet. Girevole su basamento 5 razze in alluminio verniciato o pulito con ruote, regolabile in altezza, scocca in tecnopolimero, tavoletta rotante.

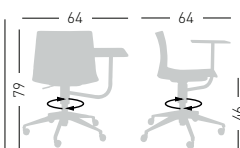

A assembled / assemblato



Frame Finishing & Codes / Finiture Telai e Codici

cod. 365.__/CO5R polished/pulita
cod. 365.__/CO5RN black painted/verniciata nera

DKK - kr

7.495
7.495

KANVAS 2
CUSHION / CUSCINO



Upholstered cushion.
Cuscino tappezzato.

Available fabric.
Tessuti disponibili.

E, K, B, DK
COM fabric / Tessuto cliente **TC**
(10pcs min.)



0,6 kg
Inside chairs boxes
Inseriti nella
scatola delle sedie

Frame Finishing & Codes / Finiture Telai e Codici

cod. 318.-- (E)
cod. 318.-- (K)
cod. 318.-- (B)
cod. 318.-- (DK)
cod. 318.TC COM fabric/tessuto cliente

DKK - kr

675
675
775
825
625

Fabric required
Fabbisogno di tessuto
4 pcs: Lin Mtrs 1,0 (h1,40)

COM fabric min. order
10pcs each code
Tessuto cliente TC ordine
min. 10pz per codice

Min. order 4pcs
each code
Ordine min 4pz
per codice

KANVAS 2
CHAIRS TROLLEY
CARRELLO PER SEDIE



Painted grey adjustable Dolly, for 4
legged chairs.
Carrello per sedie 4 gambe, regolabile,
verniciato grigio.

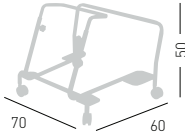

Frame Finishing & Codes / Finiture Telai e Codici

cod. 2001/A

available for models: **NA**
disponibile per versioni: **NA**

DKK - kr

2.275



0,3 m³ - 8kg
62x72x51cm.
1 pcs [carton]

KANVAS 2 UPHOLSTERED IMBOTTITE

Available coverings / Finiture disponibili
Aurea eco-leather / Ecopelle aurea **E** (4pcs min.)
King fabric / Tessuto King **K** (4pcs min.)
Blazer fabric / Tessuto Blazer **B** (4pcs min.)
Kvadrat fabrics / Tessuti Kvadrat **DK** (4pcs min.)
COM fabric / Tessuto cliente **TC** (10pcs min.)

KANVAS 2 NA FRONT



Techno-polymer shell front upholstered, chromed or painted frame.
Scocca in tecnopolimero con frontale rivestito e telaio in metallo verniciato o cromato.

Colours shell / Colori scocca

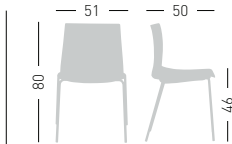
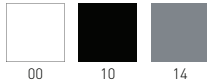

NA not assembled / non assemblato



0,48 m³ - 32 kg.
66x55x63cm.
66x55x63cm.
4 pcs [carton]

Frame Finishing & Codes / Finiture Telai e Codici

cod. 366. __-__ /IENA chromed/cromata	DKK - kr	2.295
cod. 366. __-__ /IENAB white painted/verniciato bianco		2.395
cod. 366. __-__ /IKNA chromed/cromata		2.295
cod. 366. __-__ /IKNAB white painted/verniciato bianco		2.395
cod. 366. __-__ /IBNA chromed/cromata		2.495
cod. 366. __-__ /IBNAB white painted/verniciato bianco		2.595
cod. 366. __-__ /IDKNA chromed/cromata		2.995
cod. 366. __-__ /IDKNAB white painted/verniciato bianco		3.095
cod. 366. __-__ /ITCNA chromed/cromata		2.095
cod. 366. __-__ /ITCNAB white painted/verniciato bianco		2.295

Fabric required
Fabbisogno di tessuto
1 pcs: Lin Mtrs 0,7 (h1,40)

COM fabric min. order
10pcs each code
Tessuto cliente TC ordine
min. 10pz per codice

Min. order 4pcs
each code
Ordine min 4pz
per codice

KANVAS 2 ST FRONT



Techno-polymer shell front upholstered, chromed or painted frame.
Scocca in tecnopolimero con frontale rivestito e telaio in metallo verniciato o cromato.

Colours shell / Colori scocca

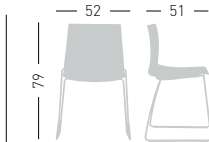
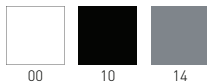

NA not assembled / non assemblato



0,48 m³ - 35 kg.
66x55x63cm.
66x55x63cm.
4 pcs [carton]

Frame Finishing & Codes / Finiture Telai e Codici

cod. 366. __-__ /IEST chromed/cromata	DKK - kr	2.295
cod. 366. __-__ /IESTB white painted/verniciato bianco		2.495
cod. 366. __-__ /IKST chromed/cromata		2.295
cod. 366. __-__ /IKSTB white painted/verniciato bianco		2.495
cod. 366. __-__ /IBST chromed/cromata		2.495
cod. 366. __-__ /IBSTB white painted/verniciato bianco		2.695
cod. 366. __-__ /IDKST chromed/cromata		2.995
cod. 366. __-__ /IDKSTB white painted/verniciato bianco		3.195
cod. 366. __-__ /ITCST chromed/cromata		2.195
cod. 366. __-__ /ITCSTB white painted/verniciato bianco		2.395

Fabric required
Fabbisogno di tessuto
1 pcs: Lin Mtrs 0,7 (h1,40)

COM fabric min. order
10pcs each code
Tessuto cliente TC ordine
min. 10pz per codice

Min. order 4pcs
each code
Ordine min 4pz
per codice

KANVAS 2 STS FRONT



Chromed or white painted sled frame with armrests, front upholstered shell.
Struttura a slitta con braccioli, cromata o verniciata bianca, scocca rivestita front.

Armrests and shell's colours are combined.
Il colore dei braccioli è abbinato alla scocca.

Colours shell / Colori scocca

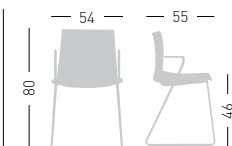
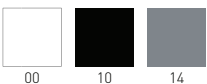

NA not assembled / non assemblato



0,62 m³ - 37 kg.
66x55x63cm.
57x63x97cm.
4 pcs [carton]

Frame Finishing & Codes / Finiture Telai e Codici

cod. 366. __-__ /IESTS chromed/cromata	DKK - kr	2.695
cod. 366. __-__ /IESTSB white painted/verniciato bianco		2.795
cod. 366. __-__ /IKSTS chromed/cromata		2.695
cod. 366. __-__ /IKSTSB white painted/verniciato bianco		2.795
cod. 366. __-__ /IBSTS chromed/cromata		2.895
cod. 366. __-__ /IBSTSB white painted/verniciato bianco		2.995
cod. 366. __-__ /IDKSTS chromed/cromata		3.395
cod. 366. __-__ /IDKSTSB white painted/verniciato bianco		3.595
cod. 366. __-__ /ITCSTS chromed/cromata		2.595
cod. 366. __-__ /ITCSTSB white painted/verniciato bianco		2.695

Fabric required
Fabbisogno di tessuto
1 pcs: Lin Mtrs 0,7 (h1,40)

COM fabric min. order
10pcs each code
Tessuto cliente TC ordine
min. 10pz per codice

Min. order 4pcs
each code
Ordine min 4pz
per codice

KANVAS 2 CTLS FRONT



Chromed or white painted cantilevered metal frame, front upholstered shell.
Struttura in metallo cantilever, cromata o verniciata bianca, scocca rivestita front.

Armrests and shell's colours are combined.
Il colore dei braccioli è abbinato alla scocca.

Colours shell / Colori scocca

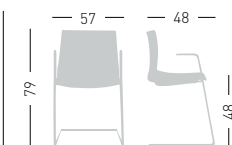

NA not assembled / non assemblato



0,62 m³ - 43 kg.
66x55x63cm.
57x63x97cm.
4 pcs [carton]

Frame Finishing & Codes / Finiture Telai e Codici

cod. 366. __-__ /IECTLS chromed/cromata	DKK - kr	2.695
cod. 366. __-__ /IECTLSB white painted/verniciato bianco		2.895
cod. 366. __-__ /IKCTLS chromed/cromata		2.695
cod. 366. __-__ /IKCTLSB white painted/verniciato bianco		2.895
cod. 366. __-__ /IBCTLS chromed/cromata		2.895
cod. 366. __-__ /IBCTLSB white painted/verniciato bianco		3.095
cod. 366. __-__ /IDKCTLS chromed/cromata		3.395
cod. 366. __-__ /IDKCTLSB white painted/verniciato bianco		3.595
cod. 366. __-__ /ITCCTLS chromed/cromata		2.595
cod. 366. __-__ /ITCCTLSB white painted/verniciato bianco		2.695

Fabric required
Fabbisogno di tessuto
1 pcs: Lin Mtrs 0,7 (h1,40)

COM fabric min. order
10pcs each code
Tessuto cliente TC ordine
min. 10pz per codice

Min. order 4pcs
each code
Ordine min 4pz
per codice

KANVAS 2 BL FRONT



Techno-polymer shell front upholstered, beech wooden frame. Scocca in tecnopolimero con frontale rivestito e base in legno di faggio.

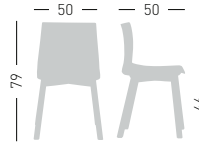

NA not assembled / non assemblato

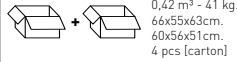

Colours shell / Colori scocca

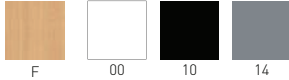

Frame Finishing & Codes / Finiture Telai e Codici

cod. 366. __-_/IEBLF
cod. 366. __-_/IKBLF
cod. 366. __-_/IBBLF
cod. 366. __-_/IDKBLF
cod. 366. __/ITCBLF E

DKK - kr

3.495
3.495
3.795
4.095
2.995

Felt Glides / Tappi in feltro

Fabric required
Fabbisogno di tessuto
1 pcs: Lin Mtrs 0,7 (h1,40)

COM fabric min. order
10pcs each code
Tessuto cliente TC ordine
min. 10pz per codice

Min. order 4pcs
each code
Ordine min 4pz
per codice

KANVAS 2 T5R FRONT



Swivel on 5-blade polished aluminum base with castors, height adjustable, techno-polymer shell front upholstered.

Girevole su base a 5 razze in alluminio pulito con ruote, regolabile in altezza, scocca in tecnopolimero con frontale rivestito.

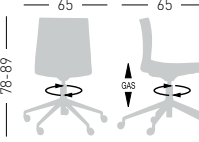

NA not assembled / non assemblato



Colours shell / Colori scocca

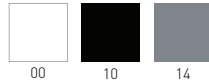

Frame Finishing & Codes / Finiture Telai e Codici

cod. 366. __-_/IET5R polished/pulita
cod. 366. __-_/IKT5R polished/pulita
cod. 366. __-_/IBT5R polished/pulita
cod. 366. __-_/IDKT5R polished/pulita
cod. 366. __/ITCT5R polished/pulita

DKK - kr

3.595
3.595
3.795
4.295
3.495

Fabric required

Fabbisogno di tessuto
1 pcs: Lin Mtrs 0,7 (h1,40)

COM fabric min. order
10pcs each code
Tessuto cliente TC ordine
min. 10pz per codice

Min. order 4pcs
each code
Ordine min 4pz
per codice

KANVAS 2 T5R BR FRONT



Swivel on 5-blade polished aluminum base with castors, height adjustable, techno-polymer shell front upholstered, with armrests.

Girevole su base a 5 razze in alluminio pulito con ruote, regolabile in altezza, scocca in tecnopolimero con frontale rivestito e braccioli.

Armrests and shell's colours are combined. Il colore dei braccioli è abbinato alla scocca.

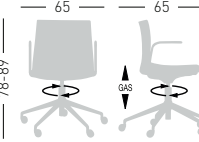

NA not assembled / non assemblato



Colours shell / Colori scocca

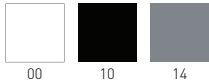

Frame Finishing & Codes / Finiture Telai e Codici

cod. 366. __-_/IET5RB polished/pulita
cod. 366. __-_/IKT5RB polished/pulita
cod. 366. __-_/IBT5RB polished/pulita
cod. 366. __-_/IDKT5RB polished/pulita
cod. 366. __/ITCT5RB polished/pulita

DKK - kr

3.995
3.995
4.195
4.695
3.895

Fabric required

Fabbisogno di tessuto
1 pcs: Lin Mtrs 0,7 (h1,40)

COM fabric min. order
10pcs each code
Tessuto cliente TC ordine
min. 10pz per codice

Min. order 4pcs
each code
Ordine min 4pz
per codice

KANVAS 2 U FRONT



Techno-polymer shell, swivel on 4-blade aluminum painted base, front upholstered shell.

Scocca in tecnopolimero, girevole su basamento verniciato in alluminio a 4 razze, scocca rivestita front.

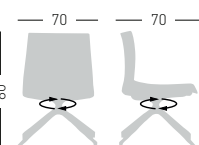

NA not assembled / non assemblato

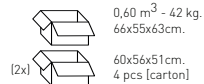

Colours shell / Colori scocca



Frame Finishing & Codes / Finiture Telai e Codici

cod.366. __-_/IKUB white/bianca
cod.366. __-_/IKUN black/nera
cod.366. __-_/IKUL polished/lucida
cod.366. __-_/IEUB white/bianca
cod.366. __-_/IEUN black/nera
cod.366. __-_/IEUL polished/lucida
cod.366. __-_/IBUB white/bianca
cod.366. __-_/IBUN black/nera
cod.366. __-_/IBUL polished/lucida
cod.366. __-_/IDKUB white/bianca
cod.366. __-_/IDKUN black/nera
cod.366. __-_/IDKUL polished/lucida
cod.366. __/ITCUB white/bianca
cod.366. __/ITCUN black/nera
cod.366. __/ITCUL polished/lucida

DKK - kr

3.395
3.395
3.595
3.395
3.395
3.595
3.595
3.595
3.695
4.095
4.095
4.295
3.195
3.195
3.295

Felt Glides / Tappi in feltro

Fabric required
Fabbisogno di tessuto
1 pcs: Lin Mtrs 0,7 (h1,40)

COM fabric min. order
10pcs each code
Tessuto cliente TC ordine
min. 10pz per codice

Min. order 4pcs
each code
Ordine min 4pz
per codice

KANVAS 2 U BR FRONT



Techno-polymer shell, swivel on 4-blade aluminum painted base, armrests, front upholstered shell. Scocca in tecnopolimero, girevole su basamento verniciato in alluminio a 4 razze, braccioli, scocca rivestita front.

Colours shell / Colori scocca

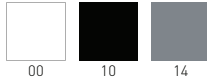

Armrests and shell's colours are combined. Il colore dei braccioli è abbinato alla scocca.

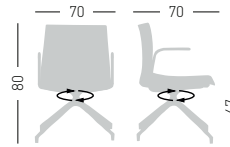

NA not assembled / non assemblato



Frame Finishing & Codes / Finiture Telai e Codici

cod. 366. __ /IKUBB white/bianca
 cod. 366. __ /IKUNB black/nera
 cod. 366. __ /IKULB polished/lucida
 cod. 366. __ /IEUBB white/bianca
 cod. 366. __ /IEUNB black/nera
 cod. 366. __ /IEULB polished/lucida
 cod. 366. __ /IBUBB white/bianca
 cod. 366. __ /IBUNB black/nera
 cod. 366. __ /IBULB polished/lucida
 cod. 366. __ /IDKUBB white/bianca
 cod. 366. __ /IDKUNB black/nera
 cod. 366. __ /IDKULB polished/lucida
 cod. 366. __ /ITCUBB white/bianca
 cod. 366. __ /ITCUNB black/nera
 cod. 366. __ /ITCULB polished/lucida

DKK - kr

3.995
 3.995
 4.095
 3.995
 3.995
 4.095
 4.095
 4.095
 4.295
 4.695
 4.695
 4.795
 3.695
 3.695
 3.895

Felt Glides / Tappi in feltro

Fabric required
 Fabbisogno di tessuto
 1 pcs: Lin Mtrs 0,7 (h1,40)

COM fabric min. order
 10pcs each code
 Tessuto cliente TC ordine
 min. 10pz per codice

Min. order 4pcs
 each code
 Ordine min 4pz
 per codice

KANVAS 2 UR FRONT



Techno-polymer shell, swivel on 4-blade aluminum painted base, with castors, front upholstered shell. Scocca in tecnopolimero, girevole su basamento verniciato in alluminio a 4 razze, su ruote, scocca rivestita front.

Colours shell / Colori scocca

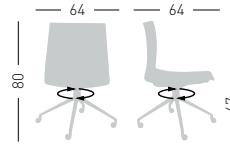
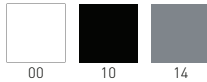

NA not assembled / non assemblato

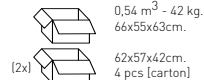

Frame Finishing & Codes / Finiture Telai e Codici

cod. 366. __ /IKURB white/bianca
 cod. 366. __ /IKURN black/nera
 cod. 366. __ /IKURL polished/lucida
 cod. 366. __ /IEURB white/bianca
 cod. 366. __ /IEURN black/nera
 cod. 366. __ /IEURL polished/lucida
 cod. 366. __ /IBURB white/bianca
 cod. 366. __ /IBURN black/nera
 cod. 366. __ /IBURL polished/lucida
 cod. 366. __ /IDKURB white/bianca
 cod. 366. __ /IDKURN black/nera
 cod. 366. __ /IDKURL polished/lucida
 cod. 366. __ /ITCURB white/bianca
 cod. 366. __ /ITCURN black/nera
 cod. 366. __ /ITCURL polished/lucida

DKK - kr

3.395
 3.395
 3.595
 3.395
 3.395
 3.595
 3.595
 3.595
 3.695
 4.095
 4.095
 4.295
 3.195
 3.195
 3.295

Fabric required

Fabbisogno di tessuto
 1 pcs: Lin Mtrs 0,7 (h1,40)

COM fabric min. order
 10pcs each code
 Tessuto cliente TC ordine
 min. 10pz per codice

Min. order 4pcs
 each code
 Ordine min 4pz
 per codice

KANVAS 2 UR BR FRONT



Techno-polymer shell, swivel on 4-blade aluminum painted base, with castors and armrests, front upholstered shell. Scocca in tecnopolimero, girevole su basamento verniciato in alluminio a 4 razze su ruote, braccioli, scocca rivestita front.

Colours shell / Colori scocca

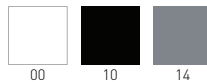

Armrests and shell's colours are combined. Il colore dei braccioli è abbinato alla scocca.

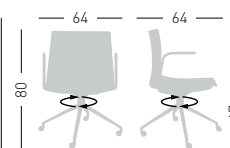

NA not assembled / non assemblato



Frame Finishing & Codes / Finiture Telai e Codici

cod. 366. __ /IKURBB white/bianca
 cod. 366. __ /IKURNB black/nera
 cod. 366. __ /IKURLB polished/lucida
 cod. 366. __ /IEURBB white/bianca
 cod. 366. __ /IEURNB black/nera
 cod. 366. __ /IEURLB polished/lucida
 cod. 366. __ /IBURBB white/bianca
 cod. 366. __ /IBURNB black/nera
 cod. 366. __ /IBURLB polished/lucida
 cod. 366. __ /IDKURBB white/bianca
 cod. 366. __ /IDKURNB black/nera
 cod. 366. __ /IDKURLB polished/lucida
 cod. 366. __ /ITCURBB white/bianca
 cod. 366. __ /ITCURNB black/nera
 cod. 366. __ /ITCURLB polished/lucida

DKK - kr

3.995
 3.995
 4.095
 3.995
 3.995
 4.095
 4.095
 4.095
 4.295
 4.695
 4.695
 4.795
 3.795
 3.795
 3.895

Fabric required

Fabbisogno di tessuto
 1 pcs: Lin Mtrs 0,7 (h1,40)

COM fabric min. order
 10pcs each code
 Tessuto cliente TC ordine
 min. 10pz per codice

Min. order 4pcs
 each code
 Ordine min 4pz
 per codice

KANVAS 2 O5R COACH FRONT



Swivel on 5-blade painted or polished aluminum base with castors, height adjustable, technopolymer shell, rotating tablet, front upholstered shell. Girevole su basamento 5 razze in alluminio verniciato o pulito con ruote, regolabile in altezza, scocca in tecnopolimero, tavoletta rotante, scocca rivestita front.

Colours shell / Colori scocca

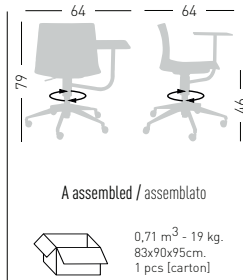
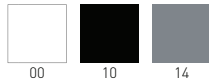

A assembled / assemblato

0,71 m³ - 19 kg.
83x90x75cm.
1 pcs [carton]

Frame Finishing & Codes / Finiture Telai e Codici

cod. 366. __- __/IECO5R polished/pulita
cod. 366. __- __/IECO5RN black painted/verniciata nera
cod. 366. __- __/IKCO5R polished/pulita
cod. 366. __- __/IKCO5RN black painted/verniciata nera
cod. 366. __- __/IBCO5R polished/pulita
cod. 366. __- __/IBCO5RN black painted/verniciata nera
cod. 366. __- __/IDKO5R polished/pulita
cod. 366. __- __/IDKO5RN black painted/verniciata nera
cod. 366. __- __/ITCO5R polished/pulita
cod. 366. __- __/ITCO5RN black painted/verniciata nera

DKK - kr

8.595
8.495
8.595
8.495
8.795
8.695
9.295
9.195
8.395
8.395

Fabric required
Fabbisogno di tessuto
1 pcs: Lin Mtrs 0,7 (h1,40)

COM fabric min. order
10pcs each code
Tessuto cliente TC ordine
min. 10pz per codice

Min. order 4pcs
each code
Ordine min 4pz
per codice

KANVAS 2 NA FULL



Chromed or white painted 4-Legged metal frame, full upholstered shell. Struttura in metallo 4 gambe, cromata o verniciata bianca, scocca rivestita full.

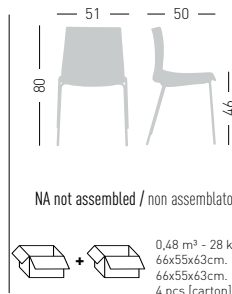

NA not assembled / non assemblato

0,48 m³ - 28 kg.
66x55x63cm.
66x55x63cm.
4 pcs [carton]

Frame Finishing & Codes / Finiture Telai e Codici

cod. 365. __/IENA chromed/cromata
cod. 365. __/IENAB white painted/verniciato bianco
cod. 365. __/IKNA chromed/cromata
cod. 365. __/IKNAB white painted/verniciato bianco
cod. 365. __/IBNA chromed/cromata
cod. 365. __/IBNAB white painted/verniciato bianco
cod. 365. __/IDKNA chromed/cromata
cod. 365. __/IDKNAB white painted/verniciato bianco
cod. 365./ITCNA chromed/cromata
cod. 365./ITCNAB white painted/verniciato bianco

DKK - kr

3.095
3.195
3.095
3.195
3.295
3.495
3.995
4.095
2.795
2.995

Fabric required
Fabbisogno di tessuto
1 pcs: Lin Mtrs 1,2 (h1,40)

COM fabric min. order
10pcs each code
Tessuto cliente TC ordine
min. 10pz per codice

Min. order 4pcs
each code
Ordine min 4pz
per codice

KANVAS 2 ST FULL



Chromed or white painted sled steel frame, full upholstered shell. Struttura a slitta, cromata o verniciata bianca, scocca rivestita full.

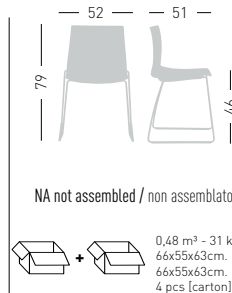

NA not assembled / non assemblato

0,48 m³ - 31 kg.
66x55x63cm.
66x55x63cm.
4 pcs [carton]

Frame Finishing & Codes / Finiture Telai e Codici

cod. 365. __/IEST chromed/cromata
cod. 365. __/IESTB white painted/verniciato bianco
cod. 365. __/IKST chromed/cromata
cod. 365. __/IKSTB white painted/verniciato bianco
cod. 365. __/IBST chromed/cromata
cod. 365. __/IBSTB white painted/verniciato bianco
cod. 365. __/IDKST chromed/cromata
cod. 365. __/IDKSTB white painted/verniciato bianco
cod. 365./ITCST chromed/cromata
cod. 365./ITCSTB white painted/verniciato bianco

DKK - kr

3.195
3.295
3.195
3.295
3.395
3.595
3.995
4.195
2.895
3.095

Fabric required
Fabbisogno di tessuto
1 pcs: Lin Mtrs 1,2 (h1,40)

COM fabric min. order
10pcs each code
Tessuto cliente TC ordine
min. 10pz per codice

Min. order 4pcs
each code
Ordine min 4pz
per codice

KANVAS 2 STS FULL



Chromed or white painted sled frame with armrests, full upholstered shell. Struttura a slitta con braccioli, cromata o verniciata bianca, scocca rivestita full.

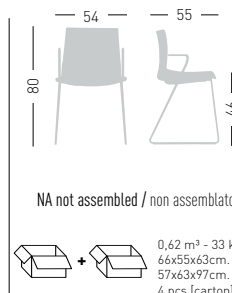

NA not assembled / non assemblato

0,62 m³ - 33 kg.
66x55x63cm.
57x63x97cm.
4 pcs [carton]

Frame Finishing & Codes / Finiture Telai e Codici

cod. 365. __- __/IESTS chromed/cromata
cod. 365. __- __/IESTSB white painted/verniciato bianco
cod. 365. __- __/IKSTS chromed/cromata
cod. 365. __- __/IKSTSB white painted/verniciato bianco
cod. 365. __- __/IBSTS chromed/cromata
cod. 365. __- __/IBSTSB white painted/verniciato bianco
cod. 365. __- __/IDKSTS chromed/cromata
cod. 365. __- __/IDKSTSB white painted/verniciato bianco
cod. 365. __/ITCSTS chromed/cromata
cod. 365. __/ITCSTSB white painted/verniciato bianco

DKK - kr

3.495
3.695
3.495
3.695
3.795
3.895
4.395
4.495
3.295
3.395

Fabric required
Fabbisogno di tessuto
1 pcs: Lin Mtrs 1,2 (h1,40)

COM fabric min. order
10pcs each code
Tessuto cliente TC ordine
min. 10pz per codice

Min. order 4pcs
each code
Ordine min 4pz
per codice

Armrests available colors
Colori per braccioli disponibili
00-06-10-14-51-54

KANVAS 2 CTLS FULL



Chromed or white painted cantilevered metal frame, full upholstered shell.
Struttura in metallo cantilever, cromata o verniciata bianca, scocca rivestita full.

Armrests available colors
Colori per braccioli disponibili
00-06-10-14-51-54



Frame Finishing & Codes / Finiture Telai e Codici

cod. 365. __-__ /IECTLS chromed/cromata	DKK - kr	3.595
cod. 365. __-__ /IECTLSB white painted/verniciato bianco		3.695
cod. 365. __-__ /IKCTLS chromed/cromata		3.595
cod. 365. __-__ /IKCTLSB white painted/verniciato bianco		3.695
cod. 365. __-__ /IBCTLS chromed/cromata		3.795
cod. 365. __-__ /IBCTLSB white painted/verniciato bianco		3.995
cod. 365. __-__ /IDKCTLS chromed/cromata		4.395
cod. 365. __-__ /IDKCTLSB white painted/verniciato bianco		4.595
cod. 365. __-__ /ITCCTLS chromed/cromata		3.295
cod. 365. __-__ /ITCCTLSB white painted/verniciato bianco		3.395

Fabric required
Fabbisogno di tessuto
1 pcs: Lin Mtrs 1,2 (h1,40)

COM fabric min. order
10pcs each code
Tessuto cliente TC ordine
min. 10pz per codice

Min. order 4pcs
each code
Ordine min 4pz
per codice

KANVAS 2 BL FULL



Techno-polymer upholstered shell and beech wood frame.
Scocca in tecnopolimero rivestita e base in legno di faggio.

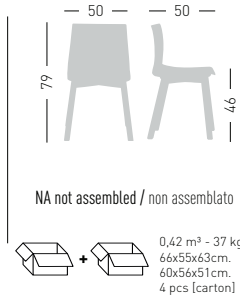

Frame Finishing & Codes / Finiture Telai e Codici

cod. 365. __-__ /IEBLF	DKK - kr	4.295
cod. 365. __-__ /IKBLF		4.295
cod. 365. __-__ /IBBLF		4.495
cod. 365. __-__ /IDKBLF		5.195
cod. 365. __-__ /ITCBLF		3.995

Felt Glides / Tappi in feltro

Fabric required
Fabbisogno di tessuto
1 pcs: Lin Mtrs 1,2 (h1,40)

COM fabric min. order
10pcs each code
Tessuto cliente TC ordine
min. 10pz per codice

Min. order 4pcs
each code
Ordine min 4pz
per codice

KANVAS 2 T5R FULL



Swivel on 5-blade polished aluminum base with castors, height adjustable, techno-polymer shell full upholstered.
Girevole su base a 5 razze in alluminio pulito con ruote, regolabile in altezza, scocca in tecnopolimero rivestita.

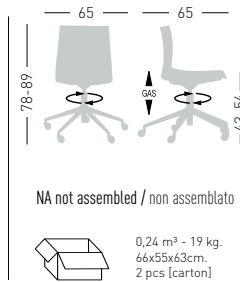

Frame Finishing & Codes / Finiture Telai e Codici

cod. 365. __-__ /IET5R polished/pulita	DKK - kr	4.495
cod. 365. __-__ /IKT5R polished/pulita		4.495
cod. 365. __-__ /IBT5R polished/pulita		4.695
cod. 365. __-__ /IDKT5R polished/pulita		5.295
cod. 365. __-__ /ITCT5R polished/pulita		4.195

Fabric required
Fabbisogno di tessuto
1 pcs: Lin Mtrs 1,2 (h1,40)

COM fabric min. order
10pcs each code
Tessuto cliente TC ordine
min. 10pz per codice

Min. order 4pcs
each code
Ordine min 4pz
per codice

KANVAS 2 T5R BR FULL



Swivel on 5-blade polished aluminum base with castors, height adjustable, techno-polymer shell full upholstered, with armrests.
Girevole su base a 5 razze in alluminio pulito con ruote, regolabile in altezza, scocca in tecnopolimero rivestita e braccioli.

Armrests available colors
Colori per braccioli disponibili
00-06-10-14-51-54

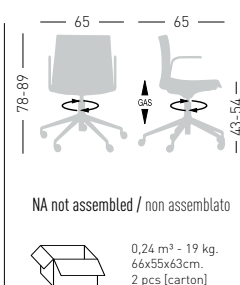

Frame Finishing & Codes / Finiture Telai e Codici

cod. 365. __-__ /IET5RB polished/pulita	DKK - kr	4.895
cod. 365. __-__ /IKT5RB polished/pulita		4.895
cod. 365. __-__ /IBT5RB polished/pulita		4.995
cod. 365. __-__ /IDKT5RB polished/pulita		5.695
cod. 365. __-__ /ITCT5RB polished/pulita		4.595

Fabric required
Fabbisogno di tessuto
1 pcs: Lin Mtrs 1,2 (h1,40)

COM fabric min. order
10pcs each code
Tessuto cliente TC ordine
min. 10pz per codice

Min. order 4pcs
each code
Ordine min 4pz
per codice

KANVAS 2 U FULL



Techno-polymer shell, swivel on 4-blade aluminum painted base, full upholstered shell.
Scocca in tecnopolimero, girevole su basamento verniciato in alluminio a 4 razze, scocca rivestita full.

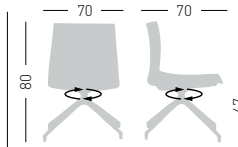

NA not assembled / non assemblato

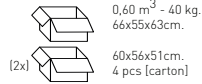

Frame Finishing & Codes / Finiture Telai e Codici

cod. 365. __/IKUB white/bianca	DKK - kr	4.295
cod. 365. __/IKUN black/nera		4.295
cod. 365. __/IKUL polished/lucida		4.395
cod. 365. __/IEUB white/bianca		4.295
cod. 365. __/IEUN black/nera		4.295
cod. 365. __/IEUL polished/lucida		4.395
cod. 365. __/IBUB white/bianca		4.495
cod. 365. __/IBUN black/nera		4.495
cod. 365. __/IBUL polished/lucida		4.595
cod. 365. __/IDKUB white/bianca		5.095
cod. 365. __/IDKUN black/nera		5.095
cod. 365. __/IDKUL polished/lucida		5.195
cod. 365./ITCUB white/bianca		3.995
cod. 365./ITCUN black/nera		3.995
cod. 365./ITCUL polished/lucida		4.095

Felt Glides / Tappi in feltro

Fabric required
Fabbisogno di tessuto
1 pcs: Lin Mtrs 1,2 (h1,40)

COM fabric min. order
10pcs each code
Tessuto cliente TC ordine
min. 10pz per codice

Min. order 4pcs
each code
Ordine min 4pz
per codice

KANVAS 2 U BR FULL



Techno-polymer shell, swivel on 4-blade aluminum painted base, armrests, full upholstered shell.
Scocca in tecnopolimero, girevole su basamento verniciato in alluminio a 4 razze, braccioli, scocca rivestita full.

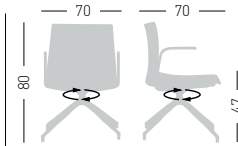

NA not assembled / non assemblato

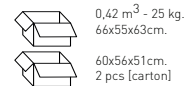

Frame Finishing & Codes / Finiture Telai e Codici

cod. 365. __- __/IKUBB white/bianca	DKK - kr	4.795
cod. 365. __- __/IKUNB black/nera		4.795
cod. 365. __- __/IKULB polished/lucida		4.995
cod. 365. __- __/IEUBB white/bianca		4.795
cod. 365. __- __/IEUNB black/nera		4.795
cod. 365. __- __/IEULB polished/lucida		4.995
cod. 365. __- __/IBUBB white/bianca		5.095
cod. 365. __- __/IBUNB black/nera		5.095
cod. 365. __- __/IBULB polished/lucida		5.195
cod. 365. __- __/IDKUBB white/bianca		5.695
cod. 365. __- __/IDKUNB black/nera		5.695
cod. 365. __- __/IDKULB polished/lucida		5.795
cod. 365. __/ITCUBB white/bianca		4.595
cod. 365. __/ITCUNB black/nera		4.595
cod. 365. __/ITCULB polished/lucida		4.695

Felt Glides / Tappi in feltro

Fabric required
Fabbisogno di tessuto
1 pcs: Lin Mtrs 1,2 (h1,40)

COM fabric min. order
10pcs each code
Tessuto cliente TC ordine
min. 10pz per codice

Min. order 4pcs
each code
Ordine min 4pz
per codice

Armrests available colors
Colori per braccioli disponibili
00-06-10-14-51-54

KANVAS 2 UR FULL



Techno-polymer shell, swivel on 4-blade aluminum painted base, with castors, full upholstered shell.
Scocca in tecnopolimero, girevole su basamento verniciato in alluminio a 4 razze, su ruote, scocca rivestita full.

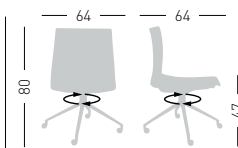

NA not assembled / non assemblato

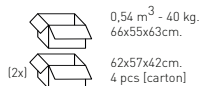

Frame Finishing & Codes / Finiture Telai e Codici

cod.365. __- __/IKURB white/bianca	DKK - kr	4.295
cod.365. __- __/IKURN black/nera		4.295
cod.365. __- __/IKURL polished/lucida		4.395
cod.365. __- __/IEURB white/bianca		4.295
cod.365. __- __/IEURN black/nera		4.295
cod.365. __- __/IEURL polished/lucida		4.395
cod.365. __- __/IBURB white/bianca		4.495
cod.365. __- __/IBURN black/nera		4.495
cod.365. __- __/IBURL polished/lucida		4.595
cod.365. __- __/IDKURB white/bianca		5.095
cod.365. __- __/IDKURN black/nera		5.095
cod.365. __- __/IDKURL polished/lucida		5.195
cod.365. __- __/ITCURB white/bianca		3.995
cod.365. __- __/ITCURN black/nera		3.995
cod.365. __- __/ITCURL polished/lucida		4.095

Fabric required
Fabbisogno di tessuto
1 pcs: Lin Mtrs 1,2 (h1,40)

COM fabric min. order
10pcs each code
Tessuto cliente TC ordine
min. 10pz per codice

Min. order 4pcs
each code
Ordine min 4pz
per codice

KANVAS 2 UR BR FULL



Techno-polymer shell, swivel on 4-blade aluminum painted base, with castors and armrests, full upholstered shell.
Scocca in tecnopolimero, girevole su basamento verniciato in alluminio a 4 razze su ruote, braccioli, scocca rivestita full.

Armrests available colors
Colori per braccioli disponibili
00-06-10-14-51-54



Frame Finishing & Codes / Finiture Telai e Codici

cod. 365./IKURB white/bianca
cod. 365./IKURN black/nera
cod. 365./IKURL polished/lucida
cod. 365./IEURB white/bianca
cod. 365./IEURN black/nera
cod. 365./IEURL polished/lucida
cod. 365./IBURB white/bianca
cod. 365./IBURN black/nera
cod. 365./IBURL polished/lucida
cod. 365./IDKURB white/bianca
cod. 365./IDKURN black/nera
cod. 365./IDKURL polished/lucida
cod. 365./ITCURB white/bianca
cod. 365./ITCURN black/nera
cod. 365./ITCURL polished/lucida

DKK - kr

4.795
4.795
4.995
4.795
4.795
4.995
5.095
5.095
5.195
5.695
5.695
5.795
4.595
4.595
4.695

Fabric required
Fabbisogno di tessuto
1 pcs: Lin Mtrs 1,2 (h1,40)

COM fabric min. order
10pcs each code
Tessuto cliente TC ordine
min. 10pz per codice

Min. order 4pcs
each code
Ordine min 4pz
per codice

KANVAS 2 05R COACH FULL



Swivel on 5-blade painted or polished aluminum base with castors, height adjustable, technopolymer shell, rotating tablet, full upholstered shell.
Girevole su basamento 5 razze in alluminio verniciato o pulito con ruote, regolabile in altezza, scocca in tecnopolimero, tavoletta rotante, scocca rivestita full.

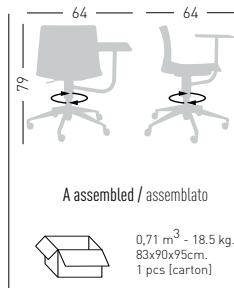

Frame Finishing & Codes / Finiture Telai e Codici

cod. 365./IEC05R polished/pulita
cod. 365./IEC05RN black painted/verniciata nera
cod. 365./IKC05R polished/pulita
cod. 365./IKC05RN black painted/verniciata nera
cod. 365./IBC05R polished/pulita
cod. 365./IBC05RN black painted/verniciata nera
cod. 365./IDKC05R polished/pulita
cod. 365./IDKC05RN black painted/verniciata nera
cod. 365./ITCC05R polished/pulita
cod. 365./ITCC05RN black painted/verniciata nera

DKK - kr

9.395
9.295
9.395
9.295
9.595
9.495
10.195
10.195
9.095
9.095

COM fabric min. order
10pcs each code
Tessuto cliente TC ordine
min. 10pz per codice

Min. order 4pcs
each code
Ordine min 4pz
per codice

Kanvas Lounge



Products follows UNI 9175 -UNI 9175/FA, in terms of Fire Resistance, Fire Reation Class 11M
 Prodotto Omologato dal Ministero dell'Interno , secondo la UNI 9175 -UNI 9175/FA, con classe di Reazione al fuoco 11M



Available coverings / Finiture disponibili
 Aurea eco-leather / Ecopelle aurea **E** (2pcs min.)
 King fabric / Tessuto King **K** (2pcs min.)
 Blazer fabric / Tessuto Blazer **B** (2pcs min.)
 Kvadrat fabrics / Tessuti Kvadrat **DK** (2pcs min.)
 COM fabric / Tessuto cliente **TC** (10pcs min.)

KANVAS LOUNGE L



Swivel on 4-blade chromed or white painted steel base, upholstered shell.
 Girevole su basamento 4 razze in acciaio cromato o verniciato bianco, scocca rivestita.

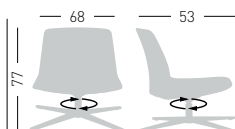

A assembled / assemblato



0,41 m³ - 18 kg.
 73x58x97cm.
 1 pcs (carton)

Frame Finishing & Codes / Finiture Telai e Codici

cod. 368.--/IKL chromed/cromata
 cod. 368.--/IKLB white painted/verniciato bianco
 cod. 368.--/IBL chromed/cromata
 cod. 368.--/IBLB white painted/verniciato bianco
 cod. 368.--/IEL chromed/cromata
 cod. 368.--/IELB white painted/verniciato bianco
 cod. 368.--/IDKL chromed/cromata
 cod. 368.--/IDKLB white painted/verniciato bianco
 cod. 368.--/ITCL chromed/cromata
 cod. 368.--/ITCLB white painted/verniciato bianco

DKK - kr

7.795
 7.795
 8.395
 8.395
 7.795
 7.795
 9.495
 9.495
 7.395
 7.395

Fabric required
 Fabbisogno di tessuto
 1 pcs: Lin Mtrs 1,5 (h1,40)

COM fabric min. order
 10pcs each code
 Tessuto cliente TC ordine
 min. 10pz per codice

Min. order 2pcs
 each code
 Ordine min 2pz
 per codice

KANVAS LOUNGE LS



Swivel on 4-blade black painted die cast aluminum base, tilt mechanism, upholstered shell.
 Girevole su basamento a 4 razze in alluminio verniciato nero, meccanismo tilt, scocca rivestita.

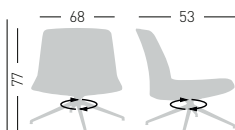

A assembled / assemblato



0,41 m³ - 18 kg.
 73x58x97cm.
 1 pcs (carton)

Frame Finishing & Codes / Finiture Telai e Codici

cod. 368.--/IKLSN
 cod. 368.--/IBLSN
 cod. 368.--/IELSN
 cod. 368.--/IDKLSN
 cod. 368.--/ITCLSN

DKK - kr

7.495
 8.095
 7.495
 9.195
 7.095

Fabric required
 Fabbisogno di tessuto
 1 pcs: Lin Mtrs 1,5 (h1,40)

COM fabric min. order
 10pcs each code
 Tessuto cliente TC ordine
 min. 10pz per codice

Min. order 2pcs
 each code
 Ordine min 2pz
 per codice

KANVAS LOUNGE ST



Chromed or Painted metal sled frame, upholstered shell.
Struttura a slitta in metallo, cromata o verniciata, scocca rivestita.

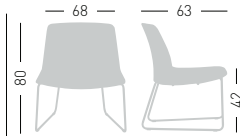

A assembled / assemblato



0,41 m³ - 13,5 kg.
73x58x97cm.
1 pcs (carton)

Frame Finishing & Codes / Finiture Telai e Codici

cod. 368. / IEST chromed/cromata
cod. 368. / IESTB white painted/verniciato bianco
cod. 368. / IESTN black painted/verniciato nero
cod. 368. / IKST chromed/cromata
cod. 368. / IKSTB white painted/verniciato bianco
cod. 368. / IKSTN black painted/verniciato nero
cod. 368. / IBST chromed/cromata
cod. 368. / IBSTB white painted/verniciato bianco
cod. 368. / IBSTN black painted/verniciato nero
cod. 368. / IDKST chromed/cromata
cod. 368. / IDKSTB white painted/verniciato bianco
cod. 368. / IDKSTN black painted/verniciato nero
cod. 368. / ITCST chromed/cromata
cod. 368. / ITCSTB white painted/verniciato bianco
cod. 368. / ITCSTN black painted/verniciato nero

DKK - kr

6.995
7.195
7.195
6.995
7.195
7.195
7.595
7.795
7.795
8.795
8.895
8.895
6.595
6.795
6.795

Fabric required
Fabbisogno di tessuto
1 pcs: Lin Mtrs 1,5 (h1,40)

COM fabric min. order
10pcs each code
Tessuto cliente TC ordine
min. 10pz per codice

Min. order 2pcs
each code
Ordine min 2pz
per codice



Available shell color / Colori disponibili scocca



Frame finishes / Finiture telaio



KASIA



4-Legged metal frame, painted with special treatment for outdoor purpose, techno-polymer shell.
Telaio 4 gambe in metallo verniciato con trattamento per esterno, scocca in tecnopolimero.

CATAS
TESTATO - TESTED

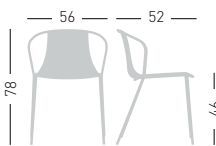

stackable / impilabile (4pcs)

A assembled / assemblato



0,35 m³ - 20 kg.
57x63x97cm.
4 pcs (carton)

Frame Finishing & Codes / Finiture Telai e Codici

cod. 186. / A_

DKK - kr

1.595

Min. order 4pcs
each code
Ordine min 4pz
per codice

KASIA B



4-Legged metal frame with armrest, painted with treatment for outdoor purpose, techno-polymer shell.
Telaio 4 gambe con braccioli in metallo verniciato con trattamento per esterno, scocca in tecnopolimero.

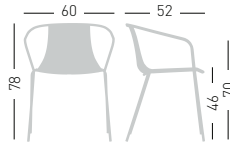

stackable / impilabile (4pcs)

A assembled / assemblato



0,35 m³ - 21 kg.
57x63x97cm.
4 pcs (carton)

Frame Finishing & Codes / Finiture Telai e Codici

cod. 187. __/A_

DKK - kr

1.695

Min. order 4pcs
each code
Ordine min 4pz
per codice

KASIA UPHOLSTERED IMBOTTITE



Suitable for outdoor purpose with MG finishes.
Adatto all'uso per esterni con finiture MG.

Available coverings / Finiture disponibili
King fabric / Tessuto King **K** (4pcs min.)
Maglia fabric / Tessuto Maglia **MG** (4pcs min.)
Superb Trevira Velvet / Velluto Superb Trevira **S** (4pcs min.)

KASIA UPHOLSTERED



4-Legged metal frame, painted with special treatment for outdoor purpose, padded and upholstered shell.

Telaio 4 gambe in metallo verniciato con trattamento per esterno, scocca imbottita e rivestita.

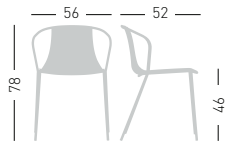

A assembled / assemblato



0,35 m³ - 11,5 kg.
57x63x97cm.
2 pcs (carton)

Frame Finishing & Codes / Finiture Telai e Codici

cod. 186. __/IKA_

cod. 186. __/IMGA_

cod. 186. __/ISA_

DKK - kr

3.295

3.295

3.295

Min. order 4pcs
each code
Ordine min 4pz
per codice

KASIA B UPHOLSTERED



4-Legged metal frame with armrest, painted with treatment for outdoor purpose, padded and upholstered shell.

Telaio 4 gambe con braccioli in metallo verniciato con trattamento per esterno, scocca imbottita e rivestita.

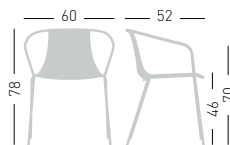

A assembled / assemblato



0,35 m³ - 12,3 kg.
57x63x97cm.
2 pcs (carton)

Frame Finishing & Codes / Finiture Telai e Codici

cod. 187. __/IKA_

cod. 187. __/IMGA_

cod. 187. __/ISA_

DKK - kr

3.395

3.395

3.395

Min. order 4pcs
each code
Ordine min 4pz
per codice

Liberty



Available colors / Colori disponibili

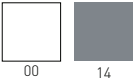

LIBERTY



Seat and back in techno-polymer, anodized aluminum legs.
Seduta e schienale in tecnopolimero e gambe in alluminio anodizzato.

CATAS
TESTATO - TESTED

BIFEMA

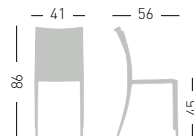

stackable / impilabile (6 pcs)

A assembled / assemblato



0,29 m³ - 20 kg.
62,5x46x97 cm.
4 pcs [carton]

Frame Finishing & Codes / Finiture Telai e Codici

cod.22.--/A

DKK - kr

995



Available colors / Colori disponibili

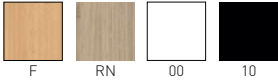

LILÀ



Chair with painted plywood shell, chromed metal frame.
Sedia con scocca in multistrato curvato verniciato, telaio cromato.

CATAS
TESTATO - TESTED

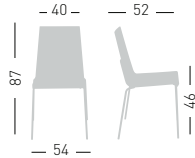

A assembled / assemblato



0,38 m³ - 18 kg.
59x65x99cm.
3 pcs (carton)

Frame Finishing & Codes / Finiture Telai e Codici

cod.184.--/A

DKK - kr

1.495

LILÀ UPHOLSTERED IMBOTTITE

Available coverings / Finiture disponibili
Regenerated leather / Pelle rigenerata **PR** (4pcs min.)

LILÀ
UPHOLSTERED



Chair in regenerated leather and chromed metal frame.
Sedia rivestita in pelle rigenerata e telaio in metallo cromato.

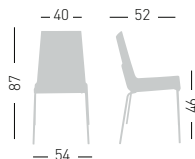

A assembled / assemblato



0,35 m³ - 13 kg.
60x60x96cm.
2 pcs (carton)

Frame Finishing & Codes / Finiture Telai e Codici

cod.184.--/IPRA chromed/cromata

DKK - kr

2.395

Min. order 4pcs
each code
Ordine min 4pz
per codice

Lilibet



Available colors / Colori disponibili



Zero Waste Selection - 100% Recycled



LILIBET

4-legged stackable techno-polymer side chair.
Sedia impilabile in tecnopolimero.

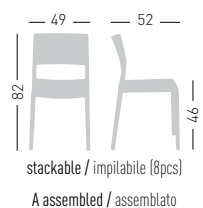

0,35 m³ - 17,6 kg.
57x63x97cm.
4 pcs (carton)

Frame Finishing & Codes / Finiture Telai e Codici

cod. 373. ___/A

DKK - kr

895

LILIBET B



4-legged stackable techno-polymer armchair.
Sedia impilabile in tecnopolimero con braccioli.

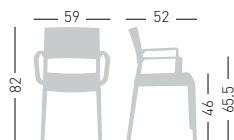

stackable / impilabile (8pcs)
A assembled / assemblato



0,35 m³ - 19,6 kg.
57x63x97cm.
4 pcs [carton]

Frame Finishing & Codes / Finiture Telai e Codici

cod.374.__/A

DKK - kr

995

LILIBET CUSHION / CUSCINO



Upholstered cushion.
Cuscino tappezzato.

Available fabric.
Tessuti disponibili.
K, MG



Suitable for outdoor purpose with MG finishes.
Adatto all'uso per esterni con finiture MG.



0,5 kg.
Inside chairs boxes
Nella scatola delle sedie.

Frame Finishing & Codes / Finiture Telai e Codici

cod.307.-- (K)
cod.307.-- (MG)

DKK - kr

575
625



Available colors / Colori disponibili

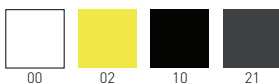

00 02 10 21

LINK



4-Legged metal chair, painted for outdoor.
Struttura 4 gambe in metallo verniciato per esterno.

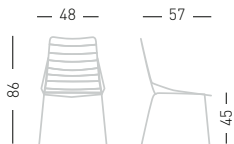

stackable / impilabile (4pcs)
A assembled / assemblato



0,31 m³ - 13 kg.
58x53,5x91,5cm.
2 pcs [carton]

Frame Finishing & Codes / Finiture Telai e Codici

cod.86.--/A

DKK - kr

2.195

Min. order 4pcs
each code
Ordine min 4pz
per codice

LINK B



4-Legged metal chair with armrests, painted for outdoor.
Struttura 4 gambe con braccioli in metallo verniciato per esterno.

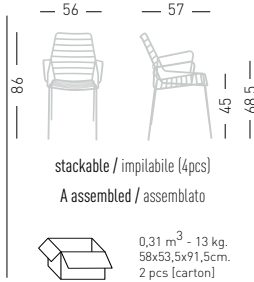

Frame Finishing & Codes / Finiture Telai e Codici

cod.88.--/A

DKK - kr 25
Ordine min 4pz
per codice

2.595

LINK CUSHION / CUSCINO



Cushion for Link chairs and armchairs, with removable cover, suitable for outdoor purpose; high density bi-elastic rubber padding, stitching made with raised edge. The cushion is fixed to the chair by Velcro straps.

Cuscino sfoderabile per sedie e sedie con braccioli Link, adatto ad uso per esterni; imbottiture in gomma bielastica ad alta densità, cucitura realizzata con bordino in rilievo riportato. Il cuscino si fissa alla sedia per mezzo di fascette in Velcro.



0,51 kg.
Inside chairs
boxes
Nella scatola
delle sedie.

Frame Finishing & Codes / Finiture Telai e Codici

cod. 336.-- (MG)

cod. 336.-- (SX)

DKK - kr

Min. order 4pcs
each code
Ordine min 4pz
per codice

750

750

Available fabric / Tessuti disponibili
Maglia fabric / Tessuto Maglia **MG**
Silvertex Fabric / Tessuto Silvertex **SX**

LINK SEAT & BACK CUSHION / CUSCINO SEDILE SCHIENALE



Cushion for Link chairs and armchairs, suitable for outdoor purpose. The cushion is fixed to the chair by clip buttons.

Cuscino per sedie e poltroncine Link, adatto ad uso per esterni. Il cuscino si fissa alla sedia per mezzo di bottoni a clip.



1 kg.
Inside chairs
boxes
Nella scatola
delle sedie.

Frame Finishing & Codes / Finiture Telai e Codici

cod.316.-- (MG)

cod.316.-- (SX)

DKK - kr

Min. order 4pcs
each code
Ordine min 4pz
per codice

1.450

1.450

Available fabric / Tessuti disponibili
Maglia fabric / Tessuto Maglia **MG**
Silvertex Fabric / Tessuto Silvertex **SX**

LINK LOUNGE



4-Legged lounge metal chair with armrests, painted for outdoor.
Seduta 4 gambe lounge con braccioli in metallo, verniciato per esterno.

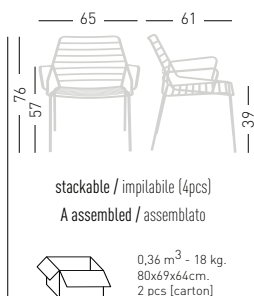

Frame Finishing & Codes / Finiture Telai e Codici

cod.84.--/A

DKK - kr

3.195

LINK LOUNGE CUSHION / CUSCINO



Cushion for Link lounge chair, with removable cover, suitable for outdoor purpose; high density bi-elastic rubber padding, stitching made with raised edge. The cushion is fixed to the chair by Velcro straps.

Cuscino sfoderabile per sedie lounge Link, adatto ad uso per esterni; imbottiture in gomma bielastica ad alta densità, cucitura realizzata con bordino in rilievo riportato. Il cuscino si fissa alla sedia per mezzo di fascette in Velcro.



0,67 kg.
Inside chairs
boxes
Nella scatola
delle sedie.

Frame Finishing & Codes / Finiture Telai e Codici

cod.340.-- (MG)

cod.340.-- (SX)

DKK - kr

Min. order 4pcs
each code
Ordine min 4pz
per codice

850

850

Available fabric / Tessuti disponibili
Maglia fabric / Tessuto Maglia **MG**
Silvertex Fabric / Tessuto Silvertex **SX**

LINK CHAISE LONGUE

Metal chaise longue, painted for outdoor.
Chaise longue in metallo, verniciato per esterno.

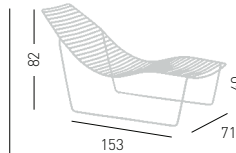

A assembled / assemblato



1,1 m³ - 17 kg,
90x165x73cm,
1 pcs (carton)

Frame Finishing & Codes / Finiture Telai e Codici

cod.85.--/A

DKK - kr

12.995



Manaa

Products follows UNI 9175 -UNI 9175/FA, in terms of
Fire Resistance, Fire Reation Class 1IM
Prodotto Omologato dal Ministero dell'Interno,
secondo la UNI 9175 -UNI 9175/FA, con classe di
Reazione al fuoco 1IM



Available coverings / Finiture disponibili
King fabric / Tessuto King **K** (4pcs min.)
Blazer fabric / Tessuto Blazer **B** (4pcs min.)
Superb Trevira Velvet / Velluto Superb Trevira **S** (4pcs min.)
Leather / Pelle **P** (4pcs min.)
Aurea eco-leather / Ecopelle Aurea **E** (4pcs min.)
Kvadrat fabrics / Tessuti Kvadrat **DK** (4pcs min.)
COM fabric / Tessuto cliente **TC** (10pcs min.)

Frame / Telaio



MANAA TP

Upholstered armchair,
techno-polymer base.
Poltrona rivestita, telaio in
tecnopolimero.

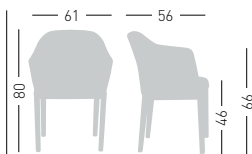

A assembled / assemblato



0,29 m³ - 10,5 kg,
59,5x53,5x91,5cm,
1 pcs (carton)

Frame Finishing & Codes / Finiture Telai e Codici

cod.255.--/IKTP--
cod.255.--/IBTP--
cod.255.--/ISTP--
cod.255.--/IPTP--
cod.255.--/IETP--
cod.255.--/IDKTP--
cod.255.--/ITCTP--

DKK - kr

4.795

5.295

5.295

5.795

4.795

5.795

4.495

Twin color upholstery details available on request
Dettagli tappezzeria bi-colore disponibili su richiesta

Fabric required
Fabbisogno di tessuto
1 pcs: Lin Mtrs 1 (h1,40)

COM fabric min. order
10pcs each code
Tessuto cliente TC ordine
min. 10pz per codice

Min. order 4pcs
each code
Ordine min 4pz
per codice

MANAA BL

Upholstered armchair,
4-Legged wooden beech frame.
Poltrona rivestita,
struttura in legno di faggio 4 gambe.



Price + DKK 150

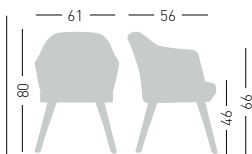

A assembled / assemblato



0,29 m³ - 11 kg,
59,5x53,5x91,5cm,
1 pcs (carton)

Frame Finishing & Codes / Finiture Telai e Codici

cod.255.--/IBBL_
cod.255.--/ISBL_
cod.255.--/IKBL_
cod.255.--/IEBL_
cod.255.--/IDKBL_
cod.255.--/IPBL_
cod.255./ITCBL_

DKK - kr

6.395

6.395

5.895

5.895

6.895

6.895

5.595

Felt Glides / Tappi in feltro

Twin color upholstery details available on request
Dettagli tappezzeria bi-colore disponibili su richiesta

Fabric required
Fabbisogno di tessuto
1 pcs: Lin Mtrs 1 (h1,40)

COM fabric min. order
10pcs each code
Tessuto cliente TC ordine
min. 10pz per codice

Min. order 4pcs
each code
Ordine min 4pz
per codice

MANAA O5R



Upholstered armchair, swivel on 5-spur polished or black painted aluminum base, tilt mechanism, height adjustable.

Poltrona rivestita, girevole su basamento 5 razze in alluminio pulito o verniciato nero, meccanismo oscillante, regolabile in altezza.

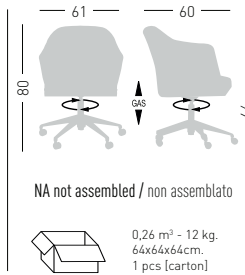

0,26 m² - 12 kg.
64x64x64cm.
1 pcs [carton]

Frame Finishing & Codes / Finiture Telai e Codici

cod.255.__/IBO5RN black/nero
 cod.255.__/IBO5R polished/lucido
 cod.255.__/ISO5RN black/nero
 cod.255.__/ISO5R polished/lucido
 cod.255.__/IKO5RN black/nero
 cod.255.__/IKO5R polished/lucido
 cod.255.__/IEO5RN black/nero
 cod.255.__/IEO5R polished/lucido
 cod.255.__/IDK05RN black/nero
 cod.255.__/IDK05R polished/lucido
 cod.255.__/IPO5RN black/nero
 cod.255.__/IPO5R polished/lucido
 cod.255.__/ITC05RN black/nero
 cod.255.__/ITC05R polished/lucido

DKK - kr

6.095
6.195
6.095
6.195
5.595
5.695
5.595
5.695
6.595
6.695
6.595
6.695
5.395
5.395

Twin color upholstery details available on request
 Dettagli tappezzeria bi-colore disponibili su richiesta

Fabric required
 Fabbisogno di tessuto
 1 pcs: Lin Mtrs 1 (h1,40)

COM fabric min. order
 10pcs each code
 Tessuto cliente TC ordine
 min. 10pz per codice

Min. order 4pcs
 each code
 Ordine min 4pz
 per codice

MANAA U



Upholstered armchair, swivel on 4-blade aluminum painted or polished base, tilt mechanism.

Poltrona rivestita, girevole su basamento verniciato o pulito in alluminio a 4 razze, meccanismo oscillante.

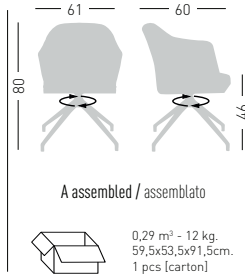

0,29 m² - 12 kg.
59,5x53,5x91,5cm.
1 pcs [carton]

Frame Finishing & Codes / Finiture Telai e Codici

cod.255.__/IBUB white/bianco
 cod.255.__/IBUN black/nero
 cod.255.__/IBUL polished/lucido
 cod.255.__/ISUB white/bianco
 cod.255.__/ISUN black/nero
 cod.255.__/ISUL polished/lucido
 cod.255.__/IKUB white/bianco
 cod.255.__/IKUN black/nero
 cod.255.__/IKUL polished/lucido
 cod.255.__/IEUB white/bianco
 cod.255.__/IEUN black/nero
 cod.255.__/IEUL polished/lucido
 cod.255.__/IDKUB white/bianco
 cod.255.__/IDKUN black/nero
 cod.255.__/IDKUL polished/lucido
 cod.255.__/IPUB white/bianco
 cod.255.__/IPUN black/nero
 cod.255.__/IPUL polished/lucido
 cod.255.__/ITCUB white/bianco
 cod.255.__/ITCUN black/nero
 cod.255.__/ITCUL polished/lucido

DKK - kr

6.395
6.395
6.495
6.395
6.395
6.495
5.895
5.895
5.995
5.895
5.895
5.995
6.895
6.895
6.995
6.895
6.895
6.995
5.695
5.695
5.795

Felt Glides / Tappi in feltro

Twin color upholstery details available on request
 Dettagli tappezzeria bi-colore disponibili su richiesta

Fabric required
 Fabbisogno di tessuto
 1 pcs: Lin Mtrs 1 (h1,40)

COM fabric min. order
 10pcs each code
 Tessuto cliente TC ordine
 min. 10pz per codice

Min. order 4pcs
 each code
 Ordine min 4pz
 per codice

Manaa Slim



Products follows UNI 9175 -UNI 9175/FA, in terms of Fire Resistance, Fire Reation Class 11M
 Prodotto Omologato dal Ministero dell'Interno, secondo la UNI 9175 -UNI 9175/FA, con classe di Reazione al fuoco 11M



Available coverings / Finiture disponibili
 King fabric / Tessuto King **K** (4pcs min.)
 Blazer fabric / Tessuto Blazer **B** (4pcs min.)
 Superb Trevira Velvet / Velluto Superb Trevira **S** (4pcs min.)
 Leather / Pelle **P** (4pcs min.)
 Aurea eco-leather / Ecopelle Aurea **E** (4pcs min.)
 Kvadrat fabrics / Tessuti Kvadrat **DK** (4pcs min.)
 COM fabric / Tessuto cliente **TC** (10pcs min.)

Frame / Telaio



MANAA SLIM TP

Upholstered chair, techno-polymer base. Poltroncina rivestita, telaio in tecnopolimero.

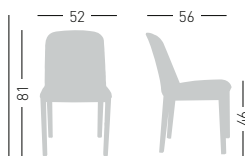

A assembled / assemblato



0,29 m² - 10 kg.
 59,5x53,5x91,5cm.
 1 pcs [carton]

Frame Finishing & Codes / Finiture Telai e Codici

cod.253.--/IKTP--
cod.253.--/IETP--
cod.253.--/IBTP--
cod.253.--/ISTP--
cod.253.--/IPTP--
cod.253.--/IDKTP--
cod.253/ITCTP--

DKK - kr

4.395
4.395
4.995
4.995
5.495
5.495
4.195

Twin color upholstery details available on request
 Dettagli tappezzeria bi-colore disponibili su richiesta

Fabric required
 Fabbisogno di tessuto
 1 pcs: Lin Mtrs 1 (h1,40)

COM fabric min. order
 10pcs each code
 Tessuto cliente TC ordine
 min. 10pz per codice

Min. order 4pcs
 each code
 Ordine min 4pz
 per codice

MANAA SLIM BL

Upholstered chair, 4-Legged wooden beech frame. Poltroncina rivestita, struttura in legno di faggio 4 gambe.

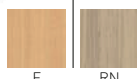

Price + DKK 150

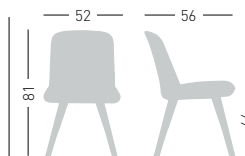

A assembled / assemblato



0,29 m² - 10 kg.
 59,5x53,5x91,5cm.
 1 pcs [carton]

Frame Finishing & Codes / Finiture Telai e Codici

cod.253.--/IKBL_
cod.253.--/IEBL_
cod.253.--/IBBL_
cod.253.--/ISBL_
cod.253.--/IPBL_
cod.253.--/IDKBL_
cod.253/ITCBL_

DKK - kr

5.495
5.495
5.995
5.995
6.495
6.495
5.295

Felt Glides / Tappi in feltro

Twin color upholstery details available on request
 Dettagli tappezzeria bi-colore disponibili su richiesta

Fabric required
 Fabbisogno di tessuto
 1 pcs: Lin Mtrs 1 (h1,40)

COM fabric min. order
 10pcs each code
 Tessuto cliente TC ordine
 min. 10pz per codice

Min. order 4pcs
 each code
 Ordine min 4pz
 per codice

MANAA SLIM 05R



Upholstered chair, swivel on 5-spur polished or black painted aluminum base, tilt mechanism, height adjustable.
Poltroncina rivestita, girevole su basamento 5 razze in alluminio lucido o verniciato nero, meccanismo oscillante, regolabile in altezza.

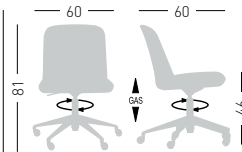

NA not assembled / non assemblato



0,26 m² - 11,5 kg.
64x64x64cm.
1 pcs [carton]



0,29 m²
59,5x53,5x91,5cm.
1 pcs [carton]

Frame Finishing & Codes / Finiture Telai e Codici

cod.253.--/IK05RN black/nero
cod.253.--/IK05R polished/lucido
cod.253.--/IE05RN black/nero
cod.253.--/IE05R polished/lucido
cod.253.--/IB05RN black/nero
cod.253.--/IB05R polished/lucido
cod.253.--/IS05RN black/nero
cod.253.--/IS05R polished/lucido
cod.253.--/IPO5RN black/nero
cod.253.--/IPO5R polished/lucido
cod.253.--/IDK05RN black/nero
cod.253.--/IDK05R polished/lucido
cod.253./ITC05RN black/nero
cod.253./ITC05R polished/lucido

DKK - kr

5.295
5.295
5.295
5.295
5.795
5.795
5.795
5.795
6.295
6.295
6.295
6.295
4.995
5.095

Twin color upholstery details available on request
Dettagli tappezzeria bi-colore disponibili su richiesta

Fabric required
Fabbisogno di tessuto
1 pcs: Lin Mtrs 1 (h1,40)

COM fabric min. order
10pcs each code
Tessuto cliente TC ordine
min. 10pz per codice

Min. order 4pcs
each code
Ordine min 4pz
per codice

MANAA SLIM U



Upholstered chair, swivel on 4-blade aluminum painted or polished base, tilt mechanism.
Poltroncina rivestita, girevole su basamento verniciato o lucido in alluminio a 4 razze, meccanismo oscillante.

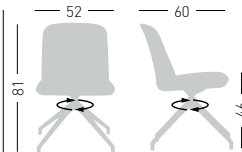

A assembled / assemblato



0,29 m² - 11 kg.
59,5x53,5x91,5cm.
1 pcs [carton]

Frame Finishing & Codes / Finiture Telai e Codici

cod. 253.--/IKUB white/bianco
cod. 253.--/IKUN black/nero
cod. 253.--/IKUL polished/lucido
cod. 253.--/IEUB white/bianco
cod. 253.--/IEUN black/nero
cod. 253.--/IEUL polished/lucido
cod. 253.--/IBUB white/bianco
cod. 253.--/IBUN black/nero
cod. 253.--/IBUL polished/lucido
cod. 253.--/ISUB white/bianco
cod. 253.--/ISUN black/nero
cod. 253.--/ISUL polished/lucido
cod. 253.--/IPUB white/bianco
cod. 253.--/IPUN black/nero
cod. 253.--/IPUL polished/lucido
cod. 253.--/IDKUB white/bianco
cod. 253.--/IDKUN black/nero
cod. 253.--/IDKUL polished/lucido
cod. 253./ITCUB white/bianco
cod. 253./ITCUN black/nero
cod. 253./ITCUL polished/lucido

DKK - kr

5.595
5.595
5.695
5.595
5.595
5.695
6.095
6.095
6.195
6.095
6.095
6.195
6.595
6.595
6.695
6.595
6.595
6.695
5.295
5.295
5.395

Felt Glides / Tappi in feltro

Twin color upholstery details available on request
Dettagli tappezzeria bi-colore disponibili su richiesta

Fabric required
Fabbisogno di tessuto
1 pcs: Lin Mtrs 1 (h1,40)

COM fabric min. order
10pcs each code
Tessuto cliente TC ordine
min. 10pz per codice

Min. order 4pcs
each code
Ordine min 4pz
per codice

Maya



Available colors / Colori disponibili

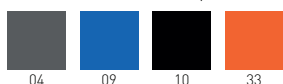

MAYA



Shell in techno polymer and anodized aluminum legs.
Scocca in tecnopolimero e gambe in alluminio anodizzato.

CATAS
TESTATO - TESTED

RIEMA

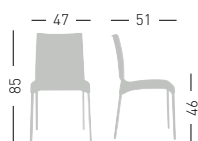

stackable / impilabile (6pcs)
A assembled / assemblato



0,37 m³ - 19kg.
47x71,5x107,3cm.
5 pcs [carton]

Frame Finishing & Codes / Finiture Telai e Codici

cod.13.--/A
cod.13.--/IGN fire retardant / ignifuga
fire retardand minimum 300 pcs
ignifuga minimo 300 pz

DKK - kr

695
995

Minush



Available colors / Colori disponibili

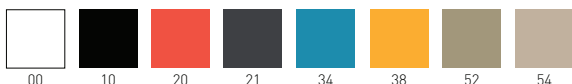

IGN Versions follows UNI 9177 certification in terms of Fire Resistance, Fire Reaction Class 1
Versioni IGN prodotto Omologato con Classe di Reazione al fuoco 1, UNI 9177



MINUSH



4-legged stackable
techno-polymer chair.
Seduta impilabile in tecnopolimero.

CATAS
TESTATO - TESTED

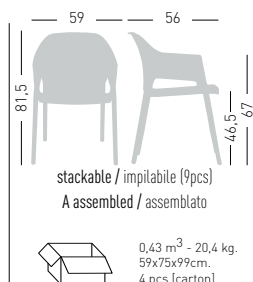

Frame Finishing & Codes / Finiture Telai e Codici

cod.220.--/A

DKK - kr

995

cod.220.--/IGN fire retardant / ignifuga

fire retardand minimum 300 pcs
ignifuga minimo 300 pz

1.195

MINUSH RELAX



4-legged stackable
techno-polymer chair.
Seduta impilabile in tecnopolimero.

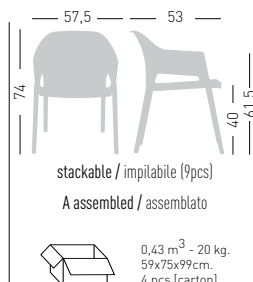

Frame Finishing & Codes / Finiture Telai e Codici

cod.221.--/A

DKK - kr

1.195

MINUSH CUSHION / CUSCINO



Removable cushion.
Cuscino removibile.

Available fabric / Tessuti disponibili
Progarden fabric / Tessuto Progarden **GR**
Silvertex Fabric / Tessuto Silvertex **SX**
Maglia fabric / Tessuto Maglia **MG**



0,060 m³ - 5 kg.
4 pcs [carton]

Frame Finishing & Codes / Finiture Telai e Codici

cod.319.-- (GR)

cod.319.-- (SX)

cod.319.-- (MG)

DKK - kr

650

650

725

Min. order 4pcs
each code
Ordine min 4pz
per codice

Moema



Available colors / Colori disponibili

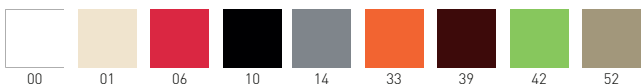

MOEMA 69

Chromed or painted 4-Legged metal frame; techno-polymer shell.
Struttura in metallo 4 gambe, cromata o verniciata; scocca in tecnopolimero.



CATAS
TESTATO - TESTED



only for paintend frames
solo per telai verniciati

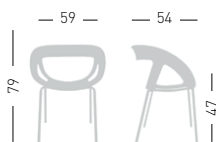

stackable / impilabile (4pcs)
NA not assembled / non assemblato



0,27 m³ - 22 kg.
64x64x64cm.
4 pcs [carton]

Frame Finishing & Codes / Finiture Telai e Codici

cod.69.--/NA chromed/cromata
cod.69.--/NAN black painted/verniciato nero
cod.69.--/NAB white painted/verniciato bianco

DKK - kr

995
1.095
1.095

MOEMA BP

4 polymer-steel co-injected legs structure, techno-polymer shell.
Struttura 4 gambe in co-iniezione metallo-polimero, scocca in tecnopolimero.

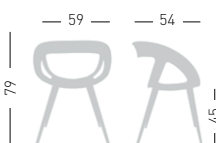

NA not assembled / non assemblato



0,24 m³ - 24,2 kg.
66x55x63cm.
4 pcs [carton]

Frame Finishing & Codes / Finiture Telai e Codici

cod.69.--/BP-- technopolymer/tecnopolimero

DKK - kr

1.595

Legs and shells colors can be combined
I colori delle gambe possono essere abbinati alla scocca

MOEMA BL

4-Legged wooden beech frame, techno-polymer shell.
Struttura in legno di faggio 4 gambe, scocca in tecnopolimero.



Price + DKK 150

F RN

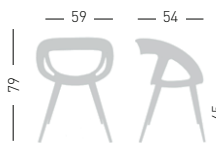

NA not assembled / non assemblato



0,36 m³ - 25,0 kg.
60x56x51cm.



60x56x51cm.
4 pcs [carton]

Frame Finishing & Codes / Finiture Telai e Codici

cod.69.--/BL_

DKK - kr

1.795

Felt Glides / Tappi in feltro

MOEMA 5R



Swivel on 5-spur polished aluminum base with castors, height adjustable, techno-polymer shell.
Girevole su basamento 5 razze con ruote in alluminio pulito, regolabile in altezza, scocca in tecnopolimero.



NA not assembled / non assemblato

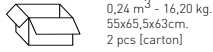

Frame Finishing & Codes / Finiture Telai e Codici

cod.69.--/5R polished/lucida

DKK - kr

2.095

MOEMA L



Swivel on 4-spur polished aluminum base, techno-polymer shell.
Girevole su basamento 4 razze in alluminio pulito, scocca in tecnopolimero.

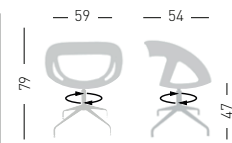

NA not assembled / non assemblato



Frame Finishing & Codes / Finiture Telai e Codici

cod.69.--/L polished/lucida

DKK - kr

2.095

Felt Glides / Tappi in feltro

MOEMA V



Swivel on chromed metal base, height adjustable, techno-polymer shell.
Girevole su basamento in metallo cromato, regolabile in altezza, scocca in tecnopolimero.

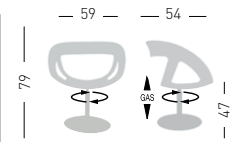

NA not assembled / non assemblato

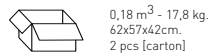

Frame Finishing & Codes / Finiture Telai e Codici

cod.69.--/V chromed/cromata

DKK - kr

1.995

MOEMA 05R



Swivel on 5-spur polished or painted aluminum base with castors, height adjustable, techno-polymer shell.
Girevole su basamento 5 razze in alluminio pulito o verniciato con ruote, regolabile in altezza, scocca in tecnopolimero.

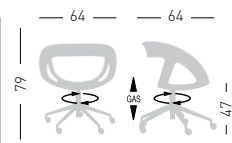

NA not assembled / non assemblato

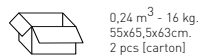

Frame Finishing & Codes / Finiture Telai e Codici

cod.69.__/05R polished/lucido
cod.69.__/05RN black/nero

DKK - kr

1.995
1.995

MOEMA U



Swivel on 4-blade aluminum painted base, with glides.
Girevole su basamento verniciato in alluminio a 4 razze su piedini.

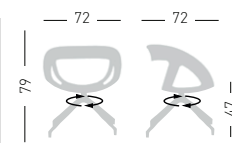

NA not assembled / non assemblato

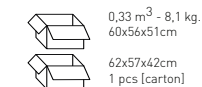

Frame Finishing & Codes / Finiture Telai e Codici

cod.69.__/UB white/bianco
cod.69.__/UN black/nero

DKK - kr

2.695
2.695

Felt Glides / Tappi in feltro

MOEMA UR



Swivel on 4-blade aluminum painted base, with castors.
Girevole su basamento verniciato in alluminio a 4 razze su ruote.

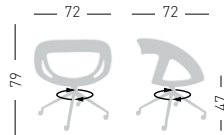

NA not assembled / non assemblato

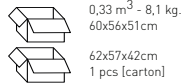

Frame Finishing & Codes / Finiture Telai e Codici

cod.69._/URB white/bianco
cod.69._/URN black/nero

DKK - kr

2.795
2.795

MOEMA CUSHION / CUSCINO



Upholstered cushion.
Cuscino tappezzato.

Available fabric.
Tessuti disponibili.
B, E, K
COM fabric / Tessuto cliente **TC**



0,6 kg.
Inside chairs boxes
Inseriti nella
scatola delle sedie

Frame Finishing & Codes / Finiture Telai e Codici

cod.310.--
cod.310.-- (B)
cod.310.TC COM fabric/tessuto cliente

DKK - kr

550
650
500

Fabric required
Fabbisogno di tessuto
4 pcs: Lin Mtrs 1,0 (h1,40)

COM fabric min. order
10pcs each code
Tessuto cliente TC ordine
min. 10pz per codice

Min. order 4pcs
each code
Ordine min 4pz
per codice

MOEMA UPHOLSTERED IMBOTTITE

Available coverings / Finiture disponibili
Leather / Pelle **P** (4pcs min.)
King fabric / Tessuto King **K** (4pcs min.)
Aurea eco-leather / Ecopelle aurea **E** (4pcs min.)
COM fabric / Tessuto cliente **TC** (10pcs min.)

MOEMA 75 UPHOLSTERED



4-Legged upholstered chair, chrome or painted, metal frame.
Sedia tappezzata 4 gambe, telaio in metallo cromato o verniciato.

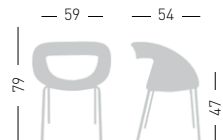

NA not assembled / non assemblato



Frame Finishing & Codes / Finiture Telai e Codici

cod.75.--/IPNA chromed/cromata
cod.75.--/IPNAN black painted/verniciato nero
cod.75.--/IPNAB white painted/verniciato bianco
cod.75.--/IKNA chromed/cromata
cod.75.--/IKNAN black painted/verniciato nero
cod.75.--/IKNAB white painted/verniciato bianco
cod.75.--/IENA chromed/cromata
cod.75.--/IENAN black painted/verniciato nero
cod.75.--/IENAB white painted/verniciato bianco
cod.75/ITCNA chromed/cromata
cod.75/ITCNAN black painted/verniciato nero
cod.75/ITCNAB white painted/verniciato bianco

DKK - kr

3.695
3.795
3.795
3.395
3.595
3.595
3.395
3.595
3.295
3.395
3.395

Fabric required
Fabbisogno di tessuto
1 pcs: Lin Mtrs 1,5 (h1,40)

COM fabric min. order
10pcs each code
Tessuto cliente TC ordine
min. 10pz per codice

Min. order 4pcs
each code
Ordine min 4pz
per codice

MOEMA BP UPHOLSTERED



4-Legged upholstered chair, metal-polymer co-injected structure.
Sedia tappezzata 4 gambe, struttura in metallo-polimero co-iniettata.

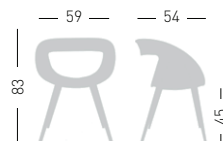

NA not assembled / non assemblato



Frame Finishing & Codes / Finiture Telai e Codici

cod.75.--/IPBP-- technopolymer/tecnopolimero
cod.75.--/IKBP-- technopolymer/tecnopolimero
cod.75.--/IEBP-- technopolymer/tecnopolimero
cod.75/ITCBP-- technopolymer/tecnopolimero

DKK - kr

3.695
3.395
3.395
3.295

Fabric required
Fabbisogno di tessuto
1 pcs: Lin Mtrs 1,5 (h1,40)

COM fabric min. order
10pcs each code
Tessuto cliente TC ordine
min. 10pz per codice

Min. order 4pcs
each code
Ordine min 4pz
per codice

MOEMA 75 BL
UPHOLSTERED



4-Legged upholstered chair, wooden beech frame.
Sedia tappezzata 4 gambe, telaio in legno di faggio.

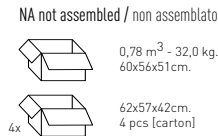
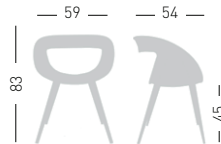
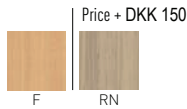

Frame Finishing & Codes / Finiture Telai e Codici

cod.75.--/IPBL_
cod.75.--/IKBL_
cod.75.--/IEBL_
cod.75./ITCBL_

DKK - kr

3.995
3.795
3.795
3.595

Felt Glides / Tappi in feltro

Fabric required
Fabbisogno di tessuto
1 pcs: Lin Mtrs 1,5 (h1,40)

COM fabric min. order
10pcs each code
Tessuto cliente TC ordine
min. 10pz per codice

Min. order 4pcs
each code
Ordine min 4pz
per codice

MOEMA 75 5R
UPHOLSTERED



Swivel upholstered chair, height adjustment, aluminum polished base.
Sedia tappezzata girevole, regolabile in altezza, base in alluminio pulito.

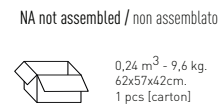
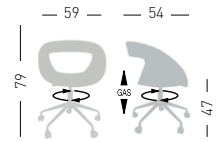

Frame Finishing & Codes / Finiture Telai e Codici

cod.75.--/IP5R polished/lucida
cod.75.--/IK5R polished/lucida
cod.75.--/IE5R polished/lucida
cod.75./ITC5R polished/lucida

DKK - kr

4.895
4.695
4.695
4.495

Fabric required
Fabbisogno di tessuto
1 pcs: Lin Mtrs 1,5 (h1,40)

COM fabric min. order
10pcs each code
Tessuto cliente TC ordine
min. 10pz per codice

Min. order 4pcs
each code
Ordine min 4pz
per codice

MOEMA 75 L
UPHOLSTERED



Swivel upholstered chair, aluminum polished base.
Sedia tappezzata girevole, base in alluminio pulito.

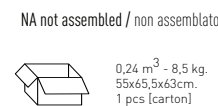
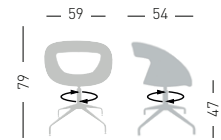

Frame Finishing & Codes / Finiture Telai e Codici

cod.75.--/IPL polished/lucida
cod.75.--/IKL polished/lucida
cod.75.--/IEL polished/lucida
cod.75./ITCL polished/lucida

DKK - kr

4.895
4.695
4.695
4.495

Felt Glides / Tappi in feltro

Fabric required
Fabbisogno di tessuto
1 pcs: Lin Mtrs 1,5 (h1,40)

COM fabric min. order
10pcs each code
Tessuto cliente TC ordine
min. 10pz per codice

Min. order 4pcs
each code
Ordine min 4pz
per codice

MOEMA 75 V
UPHOLSTERED



Swivel upholstered chair, chromed base.
Sedia tappezzata girevole, base in metallo cromato.

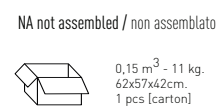
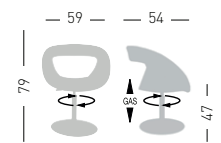

Frame Finishing & Codes / Finiture Telai e Codici

cod.75.--/IPV chromed/cromata
cod.75.--/IKV chromed/cromata
cod.75.--/IEV chromed/cromata
cod.75./ITCV chromed/cromata

DKK - kr

4.595
4.295
4.295
4.195

Fabric required
Fabbisogno di tessuto
1 pcs: Lin Mtrs 1,5 (h1,40)

COM fabric min. order
10pcs each code
Tessuto cliente TC ordine
min. 10pz per codice

Min. order 4pcs
each code
Ordine min 4pz
per codice

MOEMA 05R
UPHOLSTERED



Swivel upholstered chair, height adjustment, aluminum polished or painted base.
Sedia tappezzata girevole, regolabile in altezza, base in alluminio pulita o verniciata.

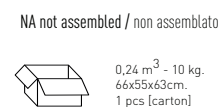
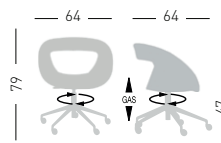

Frame Finishing & Codes / Finiture Telai e Codici

cod.75.__/IP05R polished/lucido
cod.75.__/IP05RN black/nero
cod.75.__/IK05R polished/lucido
cod.75.__/IK05RN black/nero
cod.75.__/IE05R polished/lucido
cod.75.__/IE05RN black/nero
cod.75./ITC05R polished/lucido
cod.75./ITC05RN black/nero

DKK - kr

4.795
4.795
4.595
4.495
4.595
4.495
4.495
4.395

Fabric required
Fabbisogno di tessuto
1 pcs: Lin Mtrs 1,5 (h1,40)

COM fabric min. order
10pcs each code
Tessuto cliente TC ordine
min. 10pz per codice

Min. order 4pcs
each code
Ordine min 4pz
per codice

MOEMA U
UPHOLSTERED



Swivel upholstered chair, aluminum polished or painted base.
Sedia tappezzata girevole, base in alluminio pulita o verniciata.

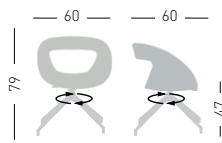

NA not assembled / non assemblato



Frame Finishing & Codes / Finiture Telai e Codici

cod.75.____/IPUB white/bianco
cod.75.____/IPUN black/nero
cod.75.____/IPUL polished/lucido
cod.75.____/IKUB white/bianco
cod.75.____/IKUN black/nero
cod.75.____/IKUL polished/lucido
cod.75.____/IEUB white/bianco
cod.75.____/IEUN black/nero
cod.75.____/IEUL polished/lucido
cod.75./ITCUB white/bianco
cod.75./ITCUN black/nero
cod.75./ITCUL polished/lucido

DKK - kr

5.095
5.095
5.295
4.895
4.895
4.995
4.895
4.895
4.995
4.795
4.795
4.895

Felt Glides / Tappi in feltro
Fabric required
Fabbisogno di tessuto
1 pcs: Lin Mtrs 1,5 (h1,40)

COM fabric min. order
10pcs each code
Tessuto cliente TC ordine
min. 10pz per codice

Min. order 4pcs
each code
Ordine min 4pz
per codice

MOEMA UR
UPHOLSTERED



Swivel upholstered chair, aluminum polished or painted base with castors.
Sedia tappezzata girevole, base in alluminio pulita o verniciata con ruote.

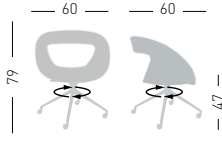

NA not assembled / non assemblato

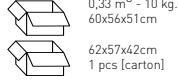

Frame Finishing & Codes / Finiture Telai e Codici

cod.75.____/IPURB white/bianco
cod.75.____/IPURN black/nero
cod.75.____/IPURL polished/lucido
cod.75.____/IKURB white/bianco
cod.75.____/IKURN black/nero
cod.75.____/IKURL polished/lucido
cod.75.____/IEURB white/bianco
cod.75.____/IEURN black/nero
cod.75.____/IEURL polished/lucido
cod.75./ITCURB white/bianco
cod.75./ITCURN black/nero
cod.75./ITCURL polished/lucido

DKK - kr

5.195
5.195
5.295
4.895
4.895
5.095
4.895
4.895
5.095
4.795
4.795
4.995

Fabric required
Fabbisogno di tessuto
1 pcs: Lin Mtrs 1,5 (h1,40)

COM fabric min. order
10pcs each code
Tessuto cliente TC ordine
min. 10pz per codice

Min. order 4pcs
each code
Ordine min 4pz
per codice



Available colors / Colori disponibili

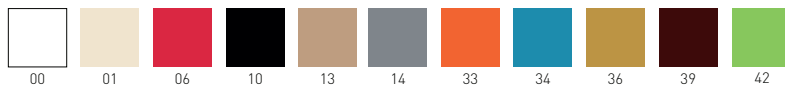

MOON



Techno-polymer chair with co-injected metal frame.
Struttura integrale in tecnopolimero con telaio metallico co-iniettato.

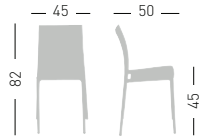

stackable / impilabile (5pcs)

A assembled / assemblato

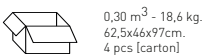

Frame Finishing & Codes / Finiture Telai e Codici

cod.30.--/A
cod.30.--/IGN fire retardant / ignifuga
fire retardand minimum 300 pcs
ignifuga minimo 300 pz

DKK - kr

995
1.295

More



Available colors / Colori disponibili

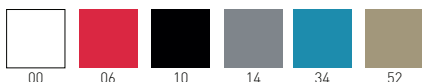

MORE NA



Chromed, white or black painted
4-Legged metal frame; techno-
polymer shell.
Struttura in metallo 4 gambe, cromata,
verniciata bianca o nera; scocca in
tecnopolimero.



only for paintend frames
solo per telai verniciati

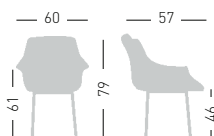

NA not assembled / non assemblato



frame / telaio
0,19 m³ - 12 kg.
62x58x52cm
4 pcs [carton]



shell / scocca
0,19 m³ - 13 kg.
62x58x52cm
4 pcs [carton]

Frame Finishing & Codes / Finiture Telai e Codici

cod.170.--/NA chromed/cromata
cod.170.--/NAN black painted/verniciato nero
cod.170.--/NAB white painted/verniciato bianco

DKK - kr

1.395
1.395
1.395

Support and glides white for shells cod. 00-52
Support and glides black for shells cod. 06-10-14-34
Supporto e tappi bianchi per scocche cod. 00-52
Supporto e tappi neri per scocche cod. 06-10-14-34

MORE TC



Chromed or white painted wire steel
metal frame, techno-polymer shell.
Struttura a traliccio in filo, cromata
o verniciata bianca, scocca in
tecnopolimero.



only for paintend frames
solo per telai verniciati

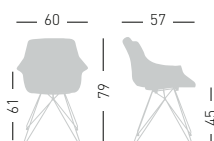

NA not assembled / non assemblato



frame / telaio
0,19 m³ - 6 kg.
62x58x52cm
2 pcs [carton]



shell / scocca
0,19 m³ - 13 kg.
62x58x52cm
2 pcs [carton]

Frame Finishing & Codes / Finiture Telai e Codici

cod.170.--/TC chromed/cromata
cod.170.--/TCB white painted/verniciato bianco
cod.170.--/TCN black painted/verniciato nero

DKK - kr

1.595
1.695
1.695

MORE BL



4-Legged wooden beech frame,
techno-polymer shell.
Struttura in legno di faggio 4 gambe,
scocca in tecnopolimero.



F

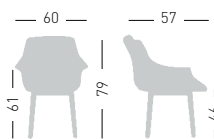

NA not assembled / non assemblato



telaio / frame
0,19 m³ - 12 kg.
62x58x52cm
4 pcs [carton]



scocca / shell
0,19 m³ - 13 kg.
62x58x52cm
4 pcs [carton]

Frame Finishing & Codes / Finiture Telai e Codici

cod.170.--/BLF beech/faggio

Felt Glides / Tappi in feltro

DKK - kr

2.295

MORE ST



Chromed or painted sled steel frame, techno-polymer shell.
Struttura a slitta, cromata o verniciata, scocca in tecnopolimero.



only for painted frames
solo per telai verniciati

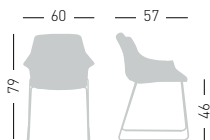

NA not assembled / non assemblato



0,24 m³ - 16 kg.
66x55x63cm
2 pcs [carton]

Frame Finishing & Codes / Finiture Telai e Codici

cod.170.--/ST chromed/cromata
cod.170.--/STB white painted/verniciato bianco
cod.170.--/STN black painted/verniciato nero

DKK - kr

1.295
1.395
1.395

MORE O5R



Swivel on 5-spur polished or painted aluminum base, height adjustable, techno-polymer shell.
Girevole su basamento 5 razze in alluminio pulito o verniciato, regolabile in altezza, scocca in tecnopolimero.

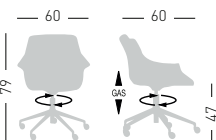

NA not assembled / non assemblato



0,24 m³ - 8,1 kg.
66x55x63cm
1 pcs [carton]

Frame Finishing & Codes / Finiture Telai e Codici

cod.170.--/O5R polished/lucida
cod.170.--/O5RN black painted/verniciata nera

DKK - kr

2.395
2.395

MORE U



Swivel on 4-blade aluminum painted base, with glides.
Girevole su basamento verniciato in alluminio a 4 razze su piedini.

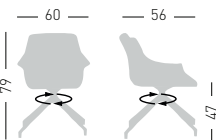

NA not assembled / non assemblato



0,33 m³ - 8,1 kg.
60x56x51cm



62x57x42cm
1 pcs [carton]

Frame Finishing & Codes / Finiture Telai e Codici

cod.170.--/UB white/bianca
cod.170.--/UN black/nera

DKK - kr

2.895
2.895

Felt Glides / Tappi in feltro

MORE UR



Swivel on 4-blade aluminum painted base, with castors.
Girevole su basamento verniciato in alluminio a 4 razze su ruote.

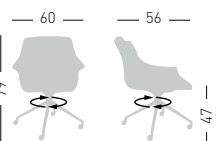

NA not assembled / non assemblato



0,33 m³ - 8,1 kg.
60x56x51cm



62x57x42cm
1 pcs [carton]

Frame Finishing & Codes / Finiture Telai e Codici

cod.170.--/URB white/bianca
cod.170.--/URN black/nera

DKK - kr

2.895
2.895

MORE CUSHION / CUSCINO



King fabric cushion.
Cuscino in tessuto King.

Available fabric.
Tessuti disponibili.

K



0,060 m³ - 2 kg.
4 pcs [carton]

Frame Finishing & Codes / Finiture Telai e Codici

cod.302.--

DKK - kr

1.775

Fixing clips are always black
I bottoni sono sempre neri

Min. order 4pcs
each code
Ordine min 4pz
per codice

MORE UPHOLSTERED IMBOTTITE

Products follows UNI 9175 -UNI 9175/FA, in terms of Fire Resistance,
Fire Reation Class 11M
Prodotto Omologato dal Ministero dell'Interno , secondo la UNI 9175 -UNI
9175/FA, con classe di Reazione al fuoco 11M



Available coverings / Finiture disponibili
King fabric / Tessuto King **K** (4pcs min.)
Aurea eco-leather / Ecopelle aurea **E** (4pcs min.)
Kvadrat fabrics / Tessuti Kvadrat **DK** (4pcs min.)
COM fabric / Tessuto cliente **TC** (10pcs min.)

MORE NA UPHOLSTERED



Upholstered PU-FLEX shell,
chromed or painted metal frame.
Scocca in PU-FLEX rivestita,
telaiio in metallo cromato o verniciato.

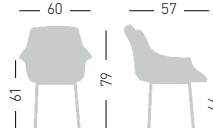

NA not assembled / non assemblato



0,19 m³ - 7 kg.
66x55x63cm
1 pcs [carton]

Frame Finishing & Codes / Finiture Telai e Codici

cod.172.--/IKNA chromed/cromata
cod.172.--/IKNAN black painted/verniciato nero
cod.172.--/IKNAB white painted/verniciato bianco
cod.172.--/IENA chromed/cromata
cod.172.--/IENAN black painted/verniciato nero
cod.172.--/IENAB white painted/verniciato bianco
cod.172.--/IDKNA chromed/cromata
cod.172.--/IDKNAN black painted/verniciato nero
cod.172.--/IDKNAB white painted/verniciato bianco
cod.172/ITCNA chromed/cromata
cod.172/ITCNAN black painted/verniciato nero
cod.172/ITCNAB white painted/verniciato bianco

DKK - kr

4.595
4.595
4.595
4.595
4.595
4.595
5.395
5.395
5.395
4.295
4.295
4.295

Fabric required
Fabbisogno di tessuto
1 pcs: Lin Mtrs 1,3 (h1,40)

COM fabric min. order
10pcs each code
Tessuto cliente TC ordine
min. 10pz per codice

Min. order 4pcs
each code
Ordine min 4pz
per codice

MORE TC UPHOLSTERED



Upholstered PU-FLEX shell,
chromed or painted metal frame.
Scocca in PU-FLEX rivestita,
telaiio in metallo cromato o verniciato.

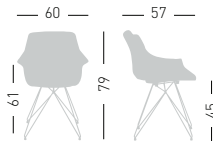

NA not assembled / non assemblato



0,19 m³ - 6 kg.
66x55x63cm
1 pcs [carton]

Frame Finishing & Codes / Finiture Telai e Codici

cod.172.--/IKTC chromed/cromata
cod.172.--/IKTCB white painted/verniciato bianco
cod.172.--/IKTCN black painted/verniciato nero
cod.172.--/IETC chromed/cromata
cod.172.--/IETCB white painted/verniciato bianco
cod.172.--/IETCN black painted/verniciato nero
cod.172.--/IDKTC chromed/cromata
cod.172.--/IDKTCB white painted/verniciato bianco
cod.172.--/IDKTCN black painted/verniciato nero
cod.172/ITCTC chromed/cromata
cod.172/ITCTCB white painted/verniciato bianco
cod.172/ITCTCN black painted/verniciato nero

DKK - kr

4.495
4.695
4.695
4.495
4.695
4.695
5.395
5.495
5.495
4.195
4.395
4.395

Fabric required
Fabbisogno di tessuto
1 pcs: Lin Mtrs 1,3 (h1,40)

COM fabric min. order
10pcs each code
Tessuto cliente TC ordine
min. 10pz per codice

Min. order 4pcs
each code
Ordine min 4pz
per codice

MORE BL UPHOLSTERED



Upholstered PU-FLEX shell,
wooden beech frame.
Scocca in PU-FLEX rivestita,
base in legno faggio.

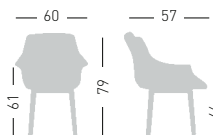

NA not assembled / non assemblato



0,27 m³ - 9 kg.
66x55x63cm
1 pcs [carton]

Frame Finishing & Codes / Finiture Telai e Codici

cod.172.--/IKBLF beech/faggio
cod.172.--/IEBLF beech/faggio
cod.172.--/IDKBLF beech/faggio
cod.172/ITCBLF beech/faggio

DKK - kr

5.795
5.795
6.595
5.495

Felt Glides / Tappi in feltro

Fabric required
Fabbisogno di tessuto
1 pcs: Lin Mtrs 1,3 (h1,40)

COM fabric min. order
10pcs each code
Tessuto cliente TC ordine
min. 10pz per codice

Min. order 4pcs
each code
Ordine min 4pz
per codice



MORE ST
UPHOLSTERED



Upholstered PU-FLEX shell, chromed or painted metal frame.
Scocca in PU-FLEX rivestita, telaio in metallo cromato o verniciato.

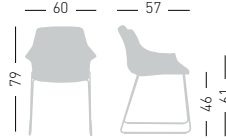

NA not assembled / non assemblato



0,24 m³ - 8,1 kg.
66x55x63cm
1 pcs [carton]

Frame Finishing & Codes / Finiture Telai e Codici

cod.172.--/IKST chromed/cromata
cod.172.--/IKSTB white painted/verniciato bianco
cod.172.--/IKSTN black painted/verniciata nera
cod.172.--/IEST chromed/cromata
cod.172.--/IESTB white painted/verniciato bianco
cod.172.--/IESTN black painted/verniciata nera
cod.172.--/IDKST chromed/cromata
cod.172.--/IDKSTB white painted/verniciato bianco
cod.172.--/IDKSTN black painted/verniciata nera
cod.172./ITCST chromed/cromata
cod.172./ITCSTB white painted/verniciato bianco
cod.172./ITCSTN black painted/verniciata nera

DKK - kr

4.595
4.795
4.795
4.595
4.795
4.795
5.495
5.595
5.595
4.295
4.495
4.495

Fabric required
Fabbisogno di tessuto
1 pcs: Lin Mtrs 1,3 (h1,40)

COM fabric min. order
10pcs each code
Tessuto cliente TC ordine
min. 10pz per codice

Min. order 4pcs
each code
Ordine min 4pz
per codice

MORE 05R
UPHOLSTERED



Upholstered PU-FLEX shell, polished or painted aluminum base.
Scocca in PU-FLEX rivestita, base in alluminio pulito o verniciato.

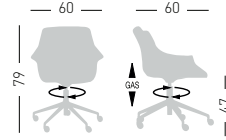

NA not assembled / non assemblato



0,24 m³ - 8,1 kg.
66x55x63cm
1 pcs [carton]

Frame Finishing & Codes / Finiture Telai e Codici

cod.172.--/IKO5R polished/lucida
cod.172.--/IKO5RN black painted/verniciata nera
cod.172.--/IEO5R polished/lucida
cod.172.--/IEO5RN black painted/verniciata nera
cod.172.--/IDKO5R polished/lucida
cod.172.--/IDKO5RN black painted/verniciata nera
cod.172./ITCO5R polished/lucida
cod.172./ITCO5RN black painted/verniciata nera

DKK - kr

5.395
5.295
5.395
5.295
6.195
6.095
4.995
4.995

Fabric required
Fabbisogno di tessuto
1 pcs: Lin Mtrs 1,3 (h1,40)

COM fabric min. order
10pcs each code
Tessuto cliente TC ordine
min. 10pz per codice

Min. order 4pcs
each code
Ordine min 4pz
per codice

MORE U
UPHOLSTERED



Upholstered PU-FLEX shell, polished or painted aluminum base.
Scocca in PU-FLEX rivestita, base in alluminio pulito o verniciato.

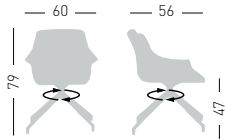

NA not assembled / non assemblato



0,33 m³ - 8,1 kg.
60x56x51cm
62x57x42cm
1 pcs [carton]

Frame Finishing & Codes / Finiture Telai e Codici

cod.172.--/IKUB white/bianca
cod.172.--/IKUN black/nera
cod.172.--/IKUL polished/lucida
cod.172.--/IEUB white/bianca
cod.172.--/IEUN black/nera
cod.172.--/IEUL polished/lucida
cod.172.--/IDKUB white/bianca
cod.172.--/IDKUN black/nera
cod.172.--/IDKUL polished/lucida
cod.172./ITCUB white/bianca
cod.172./ITCUN black/nera
cod.172./ITCUL polished/lucida

DKK - kr

5.795
5.795
5.895
5.795
5.795
5.895
6.595
6.595
6.695
5.495
5.495
5.595

Felt Glides / Tappi in feltro
Fabric required
Fabbisogno di tessuto
1 pcs: Lin Mtrs 1,3 (h1,40)

COM fabric min. order
10pcs each code
Tessuto cliente TC ordine
min. 10pz per codice

Min. order 4pcs
each code
Ordine min 4pz
per codice

MORE UR
UPHOLSTERED



Upholstered PU-FLEX shell, polished or painted aluminum base with castors.
Scocca in PU-FLEX rivestita, base in alluminio pulito o verniciato con ruote.

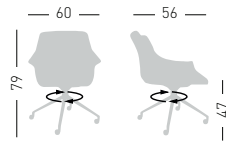

NA not assembled / non assemblato



0,33 m³ - 8,1 kg.
60x56x51cm
62x57x42cm
1 pcs [carton]

Frame Finishing & Codes / Finiture Telai e Codici

cod.172.--/IKURB white/bianca
cod.172.--/IKURN black/nera
cod.172.--/IKURL polished/lucida
cod.172.--/IEURB white/bianca
cod.172.--/IEURN black/nera
cod.172.--/IEURL polished/lucida
cod.172.--/IDKURB white/bianca
cod.172.--/IDKURN black/nera
cod.172.--/IDKURL polished/lucida
cod.172./ITCURB white/bianca
cod.172./ITCURN black/nera
cod.172./ITCURL polished/lucida

DKK - kr

5.795
5.795
5.995
5.795
5.795
5.995
6.695
6.695
6.795
5.495
5.495
5.595

Fabric required
Fabbisogno di tessuto
1 pcs: Lin Mtrs 1,3 (h1,40)

COM fabric min. order
10pcs each code
Tessuto cliente TC ordine
min. 10pz per codice

Min. order 4pcs
each code
Ordine min 4pz
per codice

Ninja



Available colors / Colori disponibili



NINJA NA



Chromed or painted 4-Legged metal frame, techno-polymer shell.
Struttura in metallo 4 gambe, cromata o verniciata, scocca in tecnopolimero.

CATAS
TESTATO - TESTED



only for painted frames
solo per telai verniciati

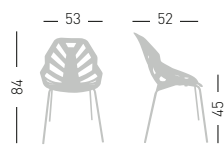

stackable / impilabile (4pcs)

NA not assembled / non assemblato



0,24 m³ - 18 kg.
55x65,5x63cm.
4 pcs [carton]

Frame Finishing & Codes / Finiture Telai e Codici

cod.65.--/NA chromed/cromata
cod.65.--/NAN black painted/verniciato nero
cod.65.--/NAB white painted/verniciato bianco

DKK - kr

795
895
895

NINJA TC



Chromed or painted wire steel metal frame, techno-polymer shell.
Struttura a traliccio in filo, cromata o verniciata, scocca in tecnopolimero.



only for painted frames
solo per telai verniciati

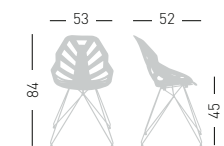

NA not assembled / non assemblato

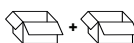

0,3 m³ - 11,6 kg.
48x61x66,5cm.
59,5x56,5x51,5cm.
2 pcs [carton]

Frame Finishing & Codes / Finiture Telai e Codici

cod.65.--/TC chromed/cromata
cod.65.--/TCB white painted/verniciato bianco
cod.65.--/TCN black painted/verniciato nero

DKK - kr

1.195
1.295
1.295

NINJA L



Swivel on 4-spur polished aluminum base, techno-polymer shell.
Girevole su basamento 4 razze in alluminio pulito, scocca in tecnopolimero.



NA not assembled / non assemblato



0,24 m³ - 11 kg.
55x65,5x63cm.
2 pcs [carton]

Frame Finishing & Codes / Finiture Telai e Codici

cod.65.--/L polished/lucida

Felt Glides / Tappi in feltro

DKK - kr

1.795

NINJA 5R



Swivel on 5-spur polished aluminum base with castors, height adjustable, techno-polymer shell.
Girevole su basamento 5 razze con ruote in alluminio pulito, regolabile in altezza, scocca in tecnopolimero.

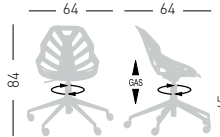

NA not assembled / non assemblato



0,24 m³ - 14 kg.
55x65,5x63cm.
2 pcs [carton]

Frame Finishing & Codes / Finiture Telai e Codici

cod.65.--/5R polished/lucida

DKK - kr

1.795



Available colors / Colori disponibili



NUTA



4-legged stackable techno-polymer chair.
Sedia impilabile in tecnopolimero.

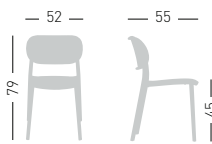

stackable / impilabile (6pcs)

A assembled / assemblato



0,38 m³ - 16 kg.
59x65x99cm
4 pcs [carton]

Frame Finishing & Codes / Finiture Telai e Codici

cod.354.--/A

DKK - kr

895

NUTA B



4-legged stackable techno-polymer chair with armrests.
Sedia impilabile in tecnopolimero con braccioli.

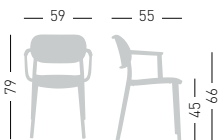

stackable / impilabile (6pcs)
A assembled / assemblato



0,38 m³ - 18 kg.
59x65x99cm
4 pcs [carton]

Frame Finishing & Codes / Finiture Telai e Codici

cod.355.--/A

DKK - kr

995

NUTA CUSHION / CUSCINO



Upholstered cushion.
Cuscino tappezzato.

Available fabric.
Tessuti disponibili.
K, B, E, DK, MG, TC



Suitable for outdoor purpose with E-MG finishes.
Adatto all'uso per esterni con finiture E-MG.



2 kg.
Inside chairs boxes
Nella scatola delle sedie.
4 pcs [carton]

Frame Finishing & Codes / Finiture Telai e Codici

cod. 327.-- (K)
cod. 327.-- (E)
cod. 327.-- (MG)
cod. 327.-- (B)
cod. 327.-- (DK)

DKK - kr

500

500

550

550

625

450

cod.327.TC COM fabric/tessuto cliente

Minimum order 4pcs each code
Ordine minimo 4 pezzi per codice

COM fabric minimum order 10pcs each code
Tessuto cliente TC ordine minimo 10pz per codice

Fabric required / Fabbisogno di tessuto
4 pcs : Lin Mtrs 1 (h1,40)

NUTA BACKREST CUSHION CUSCINO SCHIENALE



Upholstered cushion.
Cuscino tappezzato.

Available fabric.
Tessuti disponibili.
K, B, E, DK, MG, TC



Suitable for outdoor purpose with E-MG finishes.
Adatto all'uso per esterni con finiture E-MG.



2 kg.
Inside chairs boxes
Nella scatola delle sedie.
4 pcs [carton]

Frame Finishing & Codes / Finiture Telai e Codici

cod. 328.-- (K)
cod. 328.-- (E)
cod. 328.-- (MG)
cod. 328.-- (B)
cod. 328.-- (DK)

DKK - kr

550

500

550

550

625

450

cod. 328.TC COM fabric/tessuto cliente

Minimum order 4pcs each code
Ordine minimo 4 pezzi per codice

COM fabric minimum order 10pcs each code
Tessuto cliente TC ordine minimo 10pz per codice

Fabric required / Fabbisogno di tessuto
4 pcs : Lin Mtrs 0,5 (h1,40)

Nuta Light



Available frame colors / Colori disponibili telaio

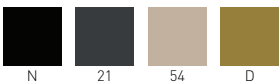

Available coverings / Finiture disponibili
King fabric / Tessuto King **K** (4pcs min.)
Maglia fabric / Tessuto Maglia **MG** (4pcs min.)
Superb Trevira Velvet / Velluto Superb Trevira **S** (4pcs min.)

NUTA LIGHT



Metal frame, padded and upholstered seat and back. Stackable chair.
Struttura in metallo a sostegno di sedile e schienale, imbottiti e rivestiti. Sedia impilabile.

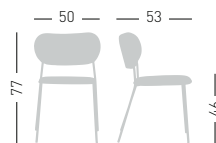

stackable / impilabile (2pcs)

A assembled / assemblato



0,28 m³ - 10,2 kg.
59x53x91cm
2 pcs [carton]

Frame Finishing & Codes / Finiture Telai e Codici

cod. 357._/IKA_
cod. 357._/IMGA_
cod. 357._/ISA_

DKK - kr

2.895

2.895

2.895

Min. order 4pcs
each code
Ordine min 4pz
per codice

NUTA LIGHT TB



Metal frame, padded and upholstered seat and back. Upholstered armrests. Struttura in metallo a sostegno di sedile e schienale, imbottiti e rivestiti. Braccioli imbottiti e rivestiti.

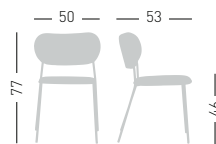

A assembled / assemblato



0,28 m³ - 7,2 kg.
59x53x91cm
1 pc [carton]

Frame Finishing & Codes / Finiture Telai e Codici

cod. 358._/IKTB_
cod. 358._/IMGTB_
cod. 358._/ISTB_

DKK - kr

3.995

3.995

3.995

Min. order 4pcs
each code
Ordine min 4pz
per codice

Armrests and shell's upholstery colours are combined.
Il colore del tessuto dei braccioli è abbinato alla scocca.

Open



Available colors / Colori disponibili

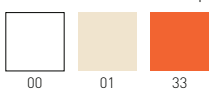

OPEN

4-Legged techno polymer chair.
Sedia 4 gambe in tecnopolimero.

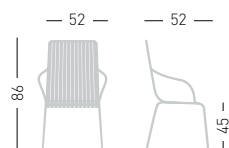

stackable / impilabile (4pcs)

A assembled / assemblato



0,41 m³ - 20 kg.
58x72,5x97cm.
4 pcs [carton]

Frame Finishing & Codes / Finiture Telai e Codici

cod.82.--/A

DKK - kr

995

Over



Available colors / Colori disponibili



OVER



4-Legged techno-polymer twin-color chair.
Sedia 4 gambe in tecnopolimero bi-colore.

CATAS
TESTATO - TESTED

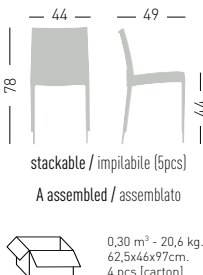

Frame Finishing & Codes / Finiture Telai e Codici

cod.36.--/A

DKK - kr

995

OVER UPHOLSTERED IMBOTTITE

Available coverings / Finiture disponibili
Eco-leather Aurea / Ecopelle Aurea **E** (4pcs min.)
COM fabric / Tessuto cliente **TC** (10pcs min.)

OVER PLUS



Full techno-polymer frame and seat upholstered in eco-leather.
Struttura integrale in tecnopolimero con seduta imbottita in ecopelle.

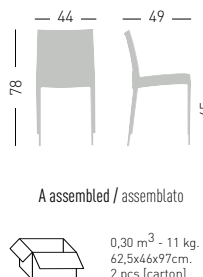

Frame Finishing & Codes / Finiture Telai e Codici

cod.36.--/IEA
cod.36/ITCA

DKK - kr

1.395
1.295

Fabric required
Fabbisogno di tessuto
4 pcs: Lin Mtrs 1 (h1,40)

COM fabric min. order
10pcs each code
Tessuto cliente TC ordine
min. 10pz per codice

Min. order 4pcs
each code
Ordine min 4pz
per codice

Panama



Available colors / Colori disponibili



PANAMA



4 legs polymer-steel co-injected structure, techno-polymer shell. Struttura 4 gambe in co-iniezione metallo-polimero, scocca in tecnopolimero.

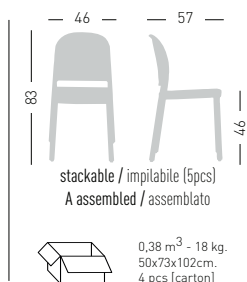

Frame Finishing & Codes / Finiture Telai e Codici

cod.240.--/A

DKK - kr

1.195

Min. order 4pcs
each code
Ordine min 4pz
per codice

PANAMA ARMREST / BRACCIOLO



4 legs polymer-steel co-injected structure, techno-polymer shell with armrests. Struttura 4 gambe in co-iniezione metallo-polimero, scocca in tecnopolimero con braccioli.

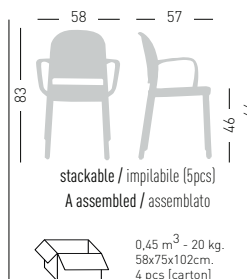

Frame Finishing & Codes / Finiture Telai e Codici

cod.241.--/A

DKK - kr

1.595

Min. order 4pcs
each code
Ordine min 4pz
per codice

PANAMA BL



4-Legged wooden beech frame, techno-polymer shell.
Struttura in legno di faggio 4 gambe, scocca in tecnopolimero.



Price + DKK 150

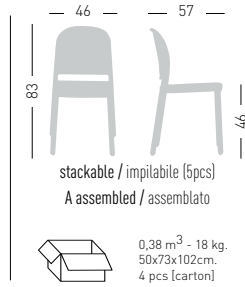

Frame Finishing & Codes / Finiture Telai e Codici

cod.240.--/BL_

Felt Glides / Tappi in feltro

DKK - kr

1.495

Min. order 4pcs
each code
Ordine min 4pz
per codice

PANAMA BL ARMREST / BRACCIOLO



4-Legged wooden beech frame, techno-polymer shell with armrests.
Struttura in legno di faggio 4 gambe, scocca in tecnopolimero con braccioli.



Price + DKK 150

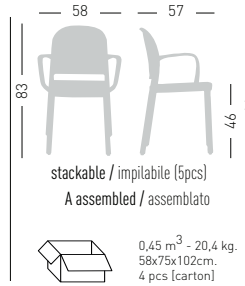

Frame Finishing & Codes / Finiture Telai e Codici

cod.241.--/BL_

Felt Glides / Tappi in feltro

DKK - kr

1.795

Min. order 4pcs
each code
Ordine min 4pz
per codice

PANAMA CUSHION / CUSCINO



Eco-leather Aurea or King fabric cushion.
Cuscino in ecopelle Aurea o tessuto King.

Available fabric.
Tessuti disponibili.

E, K



0,060 m³ - 2 kg.
4 pcs [carton]

Frame Finishing & Codes / Finiture Telai e Codici

cod.303.-- seat/sedile

cod.304.-- back/schienale

DKK - kr

625
625

It is possible to order the seat cushion only if coupled to the chair
Cuscino sedile ordinabile solo se accoppiato alla sedia

COM fabric min. order
10pcs each code
Tessuto cliente TC ordine
min. 10pz per codice

Min. order 4pcs
each code
Ordine min 4pz
per codice



Panky Seating System

Panky is the modular and customisable seating system for furnishing waiting and reception areas, based on the 2027 trestle frame that allows it to be combined with operational office furnishings. The creation of a Panky configuration entails 3 simple steps, shown hereafter: choose the frame, available in 3 lengths; compose the sofa with cushions, cushions with back and/or armrest, tops; and finally join up the composition with 45° or 90° connections, whether composed of service tops or cushions.

Panky è il sistema di sedute modulare e personalizzabile per arredare gli spazi dedicati all'attesa e all'accoglienza, basato sulla struttura a cavalletto 2027 che consente l'abbinamento con gli arredi operativi dell'ufficio. La creazione di una configurazione si svolge in 3 semplici step, riportati di seguito: scegliere la struttura, disponibile in 3 lunghezze; comporre il divano con cuscini, cuscini con schienale e/o bracciolo, piani; ed infine collegare la composizione con connessioni a 45° o 90°, siano esse realizzate con piani di servizio o cuscini.

Finishings / Finiture

Frame colors / Colori struttura



Laminated Top Color / Colore Piano Laminato

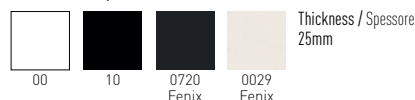

Available coverings / Finiture disponibili

King fabric / Tessuto King **K**
 Aurea eco-leather / Ecopelle Aurea **E**
 Blazer fabric / Tessuto Blazer **B**
 Leather / Pelle **P**
 Kvadrat fabrics / Tessuti Kvadrat **DK**
 COM fabric / Tessuto cliente **TC**

PANKY TWO SEATER STRUCTURE
STRUTTURA A DUE UNITÀ PANKY

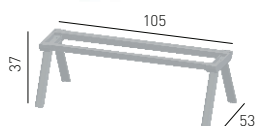

NA not assembled / non assemblato



0,03 m³ - 13 kg.
1 pcs [carton]

Frame colors / Colori struttura



Frame Finishing & Codes / Finiture Telai e Codici

cod. PK2P_

DKK - kr

2.895

PANKY THREE SEATER STRUCTURE
STRUTTURA A TRE UNITÀ PANKY

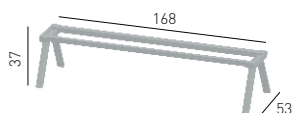

NA not assembled / non assemblato



0,05 m³ - 15 kg.
1 pcs [carton]

Frame colors / Colori struttura



Frame Finishing & Codes / Finiture Telai e Codici

cod. PK3P_

DKK - kr

3.595

PANKY FOUR SEATER STRUCTURE
STRUTTURA A QUATTRO UNITÀ PANKY

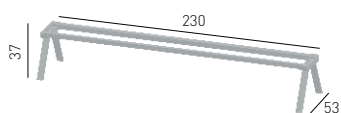

NA not assembled / non assemblato



0,06 m³ - 17 kg.
1 pcs [carton]

Frame colors / Colori struttura



Frame Finishing & Codes / Finiture Telai e Codici

cod. PK4P_

DKK - kr

3.995

PANKY SEAT MODULE
MODULO SEDUTA PANKY

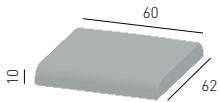

0,05 m³ - 7 kg.
1 pcs [carton]

Available coverings / Finiture disponibili

King fabric / Tessuto King **K**
Aurea eco-leather / Ecopelle Aurea **E**
Blazer fabric / Tessuto Blazer **B**
Leather / Pelle **P**
Kvadrat fabrics / Tessuti Kvadrat **DK**
COM fabric / Tessuto cliente **TC**

Finishing & Codes / Finiture e Codici

cod. 401. __/IK
cod. 401. __/IE
cod. 401. __/IB
cod. 401. __/IP
cod. 401. __/IDK
cod. 401/ITC

DKK - kr

2.095
2.095
2.395
2.795
2.795
1.895

Fabric required
Fabbisogno di tessuto
1 pcs: Lin Mtrs 0,85 (h1,40)

PANKY SEAT WITH BACK MODULE
MODULO SEDUTA CON SCHIENALE PANKY

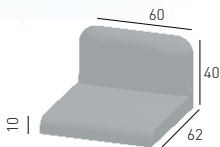

0,18 m³ - 10 kg.
1 pcs [carton]

Available coverings / Finiture disponibili

King fabric / Tessuto King **K**
Aurea eco-leather / Ecopelle Aurea **E**
Blazer fabric / Tessuto Blazer **B**
Leather / Pelle **P**
Kvadrat fabrics / Tessuti Kvadrat **DK**
COM fabric / Tessuto cliente **TC**

Finishing & Codes / Finiture e Codici

cod. 402. __/IK
cod. 402. __/IE
cod. 402. __/IB
cod. 402. __/IP
cod. 402. __/IDK
cod. 402/ITC

DKK - kr

4.195
4.195
4.795
5.195
5.195
3.695

Fabric required
Fabbisogno di tessuto
1 pcs: Lin Mtrs 1,5 (h1,40)

PANKY SEAT WITH BACK & LEFT ARMREST
MODULO SEDUTA CON SCHIENALE E BRACCIOLO SX PANKY

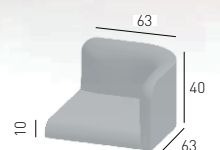

0,18 m³ - 13 kg.
1 pcs [carton]

Available coverings / Finiture disponibili

King fabric / Tessuto King **K**
Aurea eco-leather / Ecopelle Aurea **E**
Blazer fabric / Tessuto Blazer **B**
Leather / Pelle **P**
Kvadrat fabrics / Tessuti Kvadrat **DK**
COM fabric / Tessuto cliente **TC**

Finishing & Codes / Finiture e Codici

cod. 403. __/IK
cod. 403. __/IE
cod. 403. __/IB
cod. 403. __/IP
cod. 403. __/IDK
cod. 403/ITC

DKK - kr

5.495
5.495
6.195
6.795
6.795
4.995

Fabric required
Fabbisogno di tessuto
1 pcs: Lin Mtrs 2 (h1,40)

PANKY SEAT WITH BACK & RIGHT ARMREST
 MODULO SEDUTA CON SCHIENALE E BRACCIOLO DX PANKY

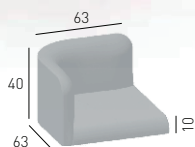

0,18 m³ - 13 kg.
1 pcs [carton]

Available coverings / Finiture disponibili
 King fabric / Tessuto King **K**
 Aurea eco-leather / Ecopelle Aurea **E**
 Blazer fabric / Tessuto Blazer **B**
 Leather / Pelle **P**
 Kvadrat fabrics / Tessuti Kvadrat **DK**
 COM fabric / Tessuto cliente **TC**

Finishing & Codes / Finiture e Codici

cod. 404. __/IK
 cod. 404. __/IE
 cod. 404. __/IB
 cod. 404. __/IP
 cod. 404. __/IDK
 cod. 404/ITC

DKK - kr

5.495
5.495
6.195
6.795
6.795
4.995

Fabric required
 Fabbisogno di tessuto
 1 pcs: Lin Mtrs 2 (h1,40)

PANKY 90° ANGULAR SEAT
 MODULO SEDUTA ANGOLARE 90° PANKY

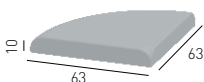

0,05 m³ - 6 kg.
1 pcs [carton]

Available coverings / Finiture disponibili
 King fabric / Tessuto King **K**
 Aurea eco-leather / Ecopelle Aurea **E**
 Blazer fabric / Tessuto Blazer **B**
 Leather / Pelle **P**
 Kvadrat fabrics / Tessuti Kvadrat **DK**
 COM fabric / Tessuto cliente **TC**

Finishing & Codes / Finiture e Codici

cod. 405. __/IK
 cod. 405. __/IE
 cod. 405. __/IB
 cod. 405. __/IP
 cod. 405. __/IDK
 cod. 405/ITC

DKK - kr

2.095
2.095
2.395
2.695
2.695
1.895

Fabric required
 Fabbisogno di tessuto
 1 pcs: Lin Mtrs 0,85 (h1,40)

PANKY 45° ANGULAR SEAT
 MODULO SEDUTA ANGOLARE 45°

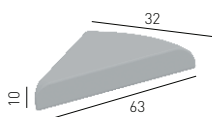

0,05 m³ - 4 kg.
1 pcs [carton]

Available coverings / Finiture disponibili
 King fabric / Tessuto King **K**
 Aurea eco-leather / Ecopelle Aurea **E**
 Blazer fabric / Tessuto Blazer **B**
 Leather / Pelle **P**
 Kvadrat fabrics / Tessuti Kvadrat **DK**
 COM fabric / Tessuto cliente **TC**

Finishing & Codes / Finiture e Codici

cod. 406. __/IK
 cod. 406. __/IE
 cod. 406. __/IB
 cod. 406. __/IP
 cod. 406. __/IDK
 cod. 406/ITC

DKK - kr

1.895
1.895
2.195
2.495
2.495
1.695

Fabric required
 Fabbisogno di tessuto
 1 pcs: Lin Mtrs 0,80 (h1,40)

PANKY SQUARE TABLE
MODULO TAVOLINO QUADRATO PANKY

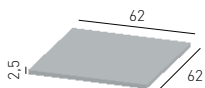

0,05 m³ - 4 kg.
1 pcs [carton]

Square Laminated table top.
Top Tavolino in Laminato quadrato.

Top Color / Colore Piano

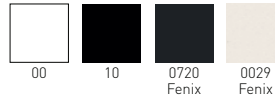

Finishing & Codes / Finiture e Codici

Cod. PTL154.__ laminated
Cod. PTL454.__ lam.fenix

DKK - kr

895
1.095

PANKY 90° ANGULAR TABLE
MODULO TAVOLINO ANGOLARE 90° PANKY

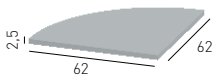

0,05 m³ - 3,5 kg.
1 pcs [carton]

90° angular Laminated table top.
Top Tavolino in Laminato angolare a 90°.

Top Color / Colore Piano



Finishing & Codes / Finiture e Codici

Cod. PTL158.__ laminated
Cod. PTL458.__ lam.fenix

DKK - kr

1.295
1.695

PANKY 45° ANGULAR TABLE
MODULO TAVOLINO ANGOLARE 45° PANKY

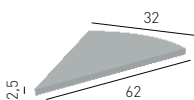

0,05 m³ - 3 kg.
1 pcs [carton]

45° angular Laminated table top.
Top Tavolino in Laminato angolare a 45°.

Top Color / Colore Piano

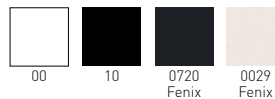

Finishing & Codes / Finiture e Codici

Cod. PTL159.__ laminated
Cod. PTL459.__ lam.fenix

DKK - kr

1.295
1.695

PANKY 90° ANGULAR CONNECTION
 MODULO CONNETTORE ANGOLARE 90° PANKY

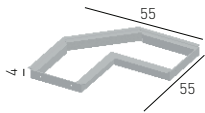

0,05 m³ - 3 kg.
 1 pcs [carton]

Panky steel angular frame 90°.
 Struttura in acciaio angolare a 90° Panky.

Frame colors / Colori struttura

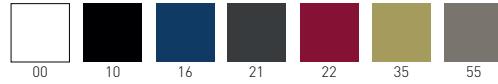

Frame Finishing & Codes / Finiture Telai e Codici

Cod. PK90A.__

DKK - kr

2.195

PANKY 45° ANGULAR CONNECTION
 MODULO CONNETTORE ANGOLARE 45° PANKY

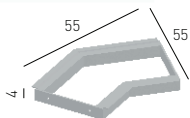

0,05 m³ - 2,8 kg.
 1 pcs [carton]

Panky steel angular frame 45°.
 Struttura in acciaio angolare a 45° Panky.

Frame colors / Colori struttura

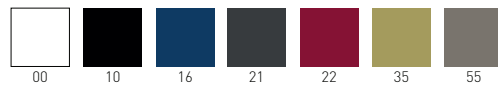

Frame Finishing & Codes / Finiture Telai e Codici

Cod. PK45A.__

DKK - kr

1.795

Place



Grand Place Collection can be customized on demand.
La collezione Grand Place può essere personalizzata su richiesta.

Products follows UNI 9175 -UNI 9175/FA, in terms of Fire Resistance, Fire Reation Class 11M
Prodotto Omologato dal Ministero dell'Interno , secondo la UNI 9175 -UNI 9175/FA, con classe di Reazione al fuoco 11M



Available coverings / Finiture disponibili
Aurea eco-leather / Ecopelle aurea **E**
King fabric / Tessuto King **K**
Kvadrat fabrics / Tessuti Kvadrat **DK**
COM fabric / Tessuto cliente **TC** (10pcs min.)

PLACE



Eco-leather or fabric upholsterd armchair, painted frame.
Poltrona rivestita in eco-pelle o tessuto, struttura in metallo verniciato.

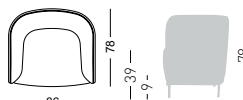

A assembled / assemblato



0,71 m³ - 18 kg.
83x90x95cm.
1 pcs [carton]

Frame Finishing & Codes / Finiture Telai e Codici

cod.280.--/IEAN black painted/verniciato nero
cod.280.--/IEAB white painted/verniciato bianco
cod.280.--/IKAN black painted/verniciato nero
cod.280.--/IKAB white painted/verniciato bianco
cod.280.--/IDKAN black painted/verniciato nero
cod.280.--/IDKAB white painted/verniciato bianco
cod.280/ITCAN black painted/verniciato nero
cod.280/ITCAB white painted/verniciato bianco

DKK - kr

10.995

10.995

10.995

10.995

13.595

13.595

10.295

10.295

Fabric required
Fabbisogno di tessuto
1 pcs: Lin Mtrs 4 (h1,40)

COM fabric min. order
10pcs each code
Tessuto cliente TC ordine
min. 10pz per codice

PLACE SOFA



Eco-leather or fabric upholsterd sofa, painted frame.
Divano rivestito in eco-pelle o tessuto, struttura in metallo verniciato.

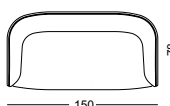

A assembled / assemblato



1,3 m³ - 28 kg.
160x90x85cm.
1 pcs [carton]

Frame Finishing & Codes / Finiture Telai e Codici

cod.281.--/IEAN black painted/verniciato nero
cod.281.--/IEAB white painted/verniciato bianco
cod.281.--/IKAN black painted/verniciato nero
cod.281.--/IKAB white painted/verniciato bianco
cod.281.--/IDKAN black painted/verniciato nero
cod.281.--/IDKAB white painted/verniciato bianco
cod.281/ITCAN black painted/verniciato nero
cod.281/ITCAB white painted/verniciato bianco

DKK - kr

15.695

15.695

15.695

15.695

19.595

19.595

14.995

14.995

Fabric required
Fabbisogno di tessuto
1 pcs: Lin Mtrs 5 (h1,40)

COM fabric min. order
10pcs each code
Tessuto cliente TC ordine
min. 10pz per codice

SMALL PLACE



Eco-leather or fabric upholsterd mini tub, painted frame.
Poltroncina rivestita in eco-pelle o tessuto, struttura in metallo verniciato.

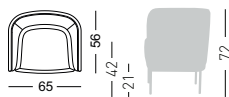

A assembled / assemblato



0,38 m³ - 12 kg.
69x69x80cm.
1 pcs [carton]

Frame Finishing & Codes / Finiture Telai e Codici

cod.282.--/IEAN black painted/verniciato nero
cod.282.--/IEAB white painted/verniciato bianco
cod.282.--/IKAN black painted/verniciato nero
cod.282.--/IKAB white painted/verniciato bianco
cod.282.--/IDKAN black painted/verniciato nero
cod.282.--/IDKAB white painted/verniciato bianco
cod.282/ITCAN black painted/verniciato nero
cod.282/ITCAB white painted/verniciato bianco

DKK - kr

7.095

7.095

7.095

7.095

8.295

8.295

6.595

6.595

Fabric required
Fabbisogno di tessuto
1 pcs: Lin Mtrs 2 (h1,40)

COM fabric min. order
10pcs each code
Tessuto cliente TC ordine
min. 10pz per codice

SMALL PLACE WOOD



Eco-leather or fabric upholstered mini tub, wooden frame.
Poltroncina rivestita in eco-pelle o tessuto, struttura in legno.

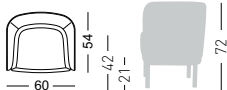

Assembled / assemblato



0,38 m³ - 12 kg.
69x69x80cm.
1 pcs (carton)

Frame Finishing & Codes / Finiture Telai e Codici

cod.282.--/IEBLF
cod.282.--/IKBLF
cod.282.--/IDKBLF
cod.282/ITCBLF

DKK - kr

7.795
7.795
9.095
7.195

Fabric required
Fabbisogno di tessuto
1 pcs: Lin Mtrs 2 (h1,40)

COM fabric min. order
10pcs each code
Tessuto cliente TC ordine
min. 10pz per codice

GRAND PLACE KIT 1



Seating modular system KIT 1
Sistema di sedute modulare KIT 1



NA not assembled / non assemblato

Frame Finishing & Codes / Finiture Telai e Codici

cod.285.K01.--/IENAN black painted/verniciato nero
cod.285.K01.--/IENAB white painted/verniciato bianco
cod.285.K01.--/IKNAN black painted/verniciato nero
cod.285.K01.--/IKNAB white painted/verniciato bianco
cod.285.K01.--/IDKNAN black painted/verniciato nero
cod.285.K01.--/IDKNAB white painted/verniciato bianco
cod.285.K01/ITCNAN black painted/verniciato nero
cod.285.K01/ITCNAB white painted/verniciato bianco

DKK - kr

12.295
12.295
12.295
12.295
13.995
13.995
11.695
11.695

Fabric required
Fabbisogno di tessuto
1 pcs: Lin Mtrs 2,1 (h1,40)

COM fabric min. order
10pcs each code
Tessuto cliente TC ordine
min. 10pz per codice

GRAND PLACE KIT 4



Seating modular system KIT 4
Sistema di sedute modulare KIT 4



NA not assembled / non assemblato

Frame Finishing & Codes / Finiture Telai e Codici

cod.285.K04.--/IENAN black painted/verniciato nero
cod.285.K04.--/IENAB white painted/verniciato bianco
cod.285.K04.--/IKNAN black painted/verniciato nero
cod.285.K04.--/IKNAB white painted/verniciato bianco
cod.285.K04.--/IDKNAN black painted/verniciato nero
cod.285.K04.--/IDKNAB white painted/verniciato bianco
cod.285.K04/ITCNAN black painted/verniciato nero
cod.285.K04/ITCNAB white painted/verniciato bianco

DKK - kr

15.395
15.395
15.395
15.395
17.495
17.495
14.195
14.195

Fabric required
Fabbisogno di tessuto
1 pcs: Lin Mtrs 3,6 (h1,40)

COM fabric min. order
10pcs each code
Tessuto cliente TC ordine
min. 10pz per codice

GRAND PLACE KIT 5



Seating modular system KIT 5
Sistema di sedute modulare KIT 5

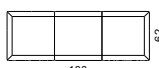

NA not assembled / non assemblato

Frame Finishing & Codes / Finiture Telai e Codici

cod.285.K05.--/IENAN black painted/verniciato nero
cod.285.K05.--/IENAB white painted/verniciato bianco
cod.285.K05.--/IKNAN black painted/verniciato nero
cod.285.K05.--/IKNAB white painted/verniciato bianco
cod.285.K05.--/IDKNAN black painted/verniciato nero
cod.285.K05.--/IDKNAB white painted/verniciato bianco
cod.285.K05/ITCNAN black painted/verniciato nero
cod.285.K05/ITCNAB white painted/verniciato bianco

DKK - kr

12.095
12.095
12.095
12.095
13.695
13.695
11.195
11.195

Fabric required
Fabbisogno di tessuto
1 pcs: Lin Mtrs 2,8 (h1,40)

COM fabric min. order
10pcs each code
Tessuto cliente TC ordine
min. 10pz per codice

GRAND PLACE KIT 6



Seating modular system KIT 6
Sistema di sedute modulare KIT 6

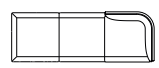

NA not assembled / non assemblato

Frame Finishing & Codes / Finiture Telai e Codici

cod.285.K06.--/IENAN black painted/verniciato nero
cod.285.K06.--/IENAB white painted/verniciato bianco
cod.285.K06.--/IKNAN black painted/verniciato nero
cod.285.K06.--/IKNAB white painted/verniciato bianco
cod.285.K06.--/IDKNAN black painted/verniciato nero
cod.285.K06.--/IDKNAB white painted/verniciato bianco
cod.285.K06/ITCNAN black painted/verniciato nero
cod.285.K06/ITCNAB white painted/verniciato bianco

DKK - kr

15.995
15.995
15.995
15.995
17.995
17.995
14.795
14.795

Fabric required
Fabbisogno di tessuto
1 pcs: Lin Mtrs 4 (h1,40)

COM fabric min. order
10pcs each code
Tessuto cliente TC ordine
min. 10pz per codice

GRAND PLACE KIT 7

Seating modular system KIT 7
Sistema di sedute modulare KIT 7

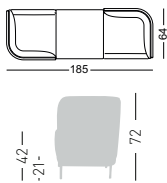

NA not assembled / non assemblato

Frame Finishing & Codes / Finiture Telai e Codici

cod.285.K07.--/IENAN black painted/verniciato nero	DKK - kr	19.995
cod.285.K07.--/IENAB white painted/verniciato bianco		19.995
cod.285.K07.--/IKNAN black painted/verniciato nero		19.995
cod.285.K07.--/IKNAB white painted/verniciato bianco		19.995
cod.285.K07.--/IDKNAN black painted/verniciato nero		23.295
cod.285.K07.--/IDKNAB white painted/verniciato bianco		23.295
cod.285.K07/ITCNAN black painted/verniciato nero		18.695
cod.285.K07/ITCNAB white painted/verniciato bianco		18.695

Fabric required
Fabbisogno di tessuto
1 pcs: Lin Mtrs 4,5 (h1,40)

COM fabric min. order
10pcs each code
Tessuto cliente TC ordine
min. 10pz per codice

GRAND PLACE KIT 8

Seating modular system KIT 8
Sistema di sedute modulare KIT 8

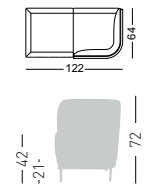

NA not assembled / non assemblato

Frame Finishing & Codes / Finiture Telai e Codici

cod.285.K08.--/IENAN black painted/verniciato nero	DKK - kr	12.095
cod.285.K08.--/IENAB white painted/verniciato bianco		12.095
cod.285.K08.--/IKNAN black painted/verniciato nero		12.095
cod.285.K08.--/IKNAB white painted/verniciato bianco		12.095
cod.285.K08.--/IDKNAN black painted/verniciato nero		13.995
cod.285.K08.--/IDKNAB white painted/verniciato bianco		13.995
cod.285.K08/ITCNAN black painted/verniciato nero		11.195
cod.285.K08/ITCNAB white painted/verniciato bianco		11.195

Fabric required
Fabbisogno di tessuto
1 pcs: Lin Mtrs 3 (h1,40)

COM fabric min. order
10pcs each code
Tessuto cliente TC ordine
min. 10pz per codice

GRAND PLACE KIT 9

Seating modular system KIT 9
Sistema di sedute modulare KIT 9

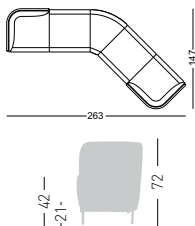

NA not assembled / non assemblato

Frame Finishing & Codes / Finiture Telai e Codici

cod.285.K09.--/IENAN black painted/verniciato nero	DKK - kr	30.495
cod.285.K09.--/IENAB white painted/verniciato bianco		30.495
cod.285.K09.--/IKNAN black painted/verniciato nero		30.495
cod.285.K09.--/IKNAB white painted/verniciato bianco		30.495
cod.285.K09.--/IDKNAN black painted/verniciato nero		34.595
cod.285.K09.--/IDKNAB white painted/verniciato bianco		34.595
cod.285.K09/ITCNAN black painted/verniciato nero		28.395
cod.285.K09/ITCNAB white painted/verniciato bianco		28.395

Fabric required
Fabbisogno di tessuto
1 pcs: Lin Mtrs 6,9 (h1,40)

COM fabric min. order
10pcs each code
Tessuto cliente TC ordine
min. 10pz per codice

GRAND PLACE KIT 10

Seating modular system KIT 10
Sistema di sedute modulare KIT 10

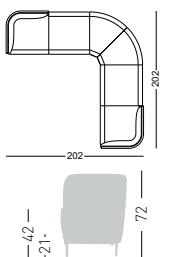

NA not assembled / non assemblato

Frame Finishing & Codes / Finiture Telai e Codici

cod.285.K10.--/IENAN black painted/verniciato nero	DKK - kr	33.795
cod.285.K10.--/IENAB white painted/verniciato bianco		33.795
cod.285.K10.--/IKNAN black painted/verniciato nero		33.795
cod.285.K10.--/IKNAB white painted/verniciato bianco		33.795
cod.285.K10.--/IDKNAN black painted/verniciato nero		38.395
cod.285.K10.--/IDKNAB white painted/verniciato bianco		38.395
cod.285.K10/ITCNAN black painted/verniciato nero		31.395
cod.285.K10/ITCNAB white painted/verniciato bianco		31.395

Fabric required
Fabbisogno di tessuto
1 pcs: Lin Mtrs 7,7 (h1,40)

COM fabric min. order
10pcs each code
Tessuto cliente TC ordine
min. 10pz per codice

GRAND PLACE KIT 11

Seating modular system KIT 11
Sistema di sedute modulare KIT 11

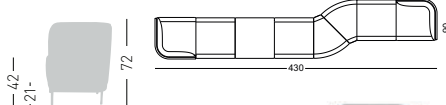
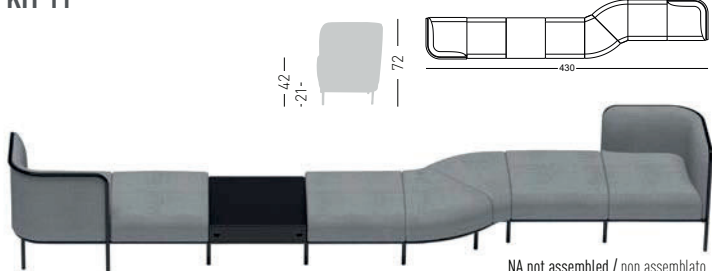

NA not assembled / non assemblato

Frame Finishing & Codes / Finiture Telai e Codici

cod.285.K11.--/IENAN black painted/verniciato nero	DKK - kr	41.595
cod.285.K11.--/IENAB white painted/verniciato bianco		41.595
cod.285.K11.--/IKNAN black painted/verniciato nero		41.595
cod.285.K11.--/IKNAB white painted/verniciato bianco		41.595
cod.285.K11.--/IDKNAN black painted/verniciato nero		47.895
cod.285.K11.--/IDKNAB white painted/verniciato bianco		47.895
cod.285.K11/ITCNAN black painted/verniciato nero		38.895
cod.285.K11/ITCNAB white painted/verniciato bianco		38.895

Fabric required
Fabbisogno di tessuto
1 pcs: Lin Mtrs 8,5 (h1,40)

COM fabric min. order
10pcs each code
Tessuto cliente TC ordine
min. 10pz per codice

GRAND PLACE KIT 12

Seating modular system KIT 12
Sistema di sedute modulare KIT 12

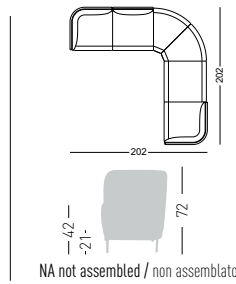

Frame Finishing & Codes / Finiture Telai e Codici

cod.285.K12.--/IENAN black painted/verniciato nero
cod.285.K12.--/IENAB white painted/verniciato bianco
cod.285.K12.--/IKNAN black painted/verniciato nero
cod.285.K12.--/IKNAB white painted/verniciato bianco
cod.285.K12.--/IDKNAN black painted/verniciato nero
cod.285.K12.--/IDKNAB white painted/verniciato bianco
cod.285.K12/ITCNAN black painted/verniciato nero
cod.285.K12/ITCNAB white painted/verniciato bianco

DKK - kr

35.795
35.795
35.795
35.795
40.395
40.395
33.395
33.395

Fabric required
Fabbisogno di tessuto
1 pcs: Lin Mtrs 8 (h1,40)

COM fabric min. order
10pcs each code
Tessuto cliente TC ordine
min. 10pz per codice



Prisma

Available colors / Colori disponibili

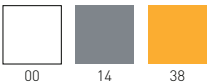

00 14 38

PRISMA

4-Legged techno-polymer chair.
Sedia 4 gambe in tecnopolimero.

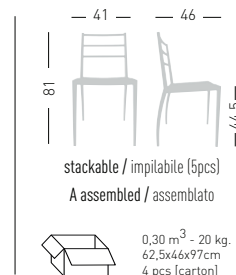

Frame Finishing & Codes / Finiture Telai e Codici

cod.40.--/A

DKK - kr

995



Available colors / Colori disponibili

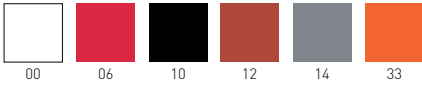

PRODIGE NA



Chromed or painted 4-Legged metal frame, techno-polymer shell.
Struttura in metallo 4 gambe, cromata o verniciata, scocca in tecnopolimero.



only for painted frames
solo per telai verniciati

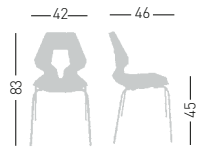

stackable / impilabile (5pcs)
NA not assembled / non assemblato



0,18 m³ - 17,2 kg.
59,5x56,5x51,5 cm
4 pcs [carton]

Frame Finishing & Codes / Finiture Telai e Codici

cod.55.--/NA chromed/cromata
cod.55.--/NAN black painted/verniciato nero
cod.55.--/NAB white painted/verniciato bianco

DKK - kr

795
895
895

PRODIGE 5R



Swivel on 5-spur polished aluminum base with castors, height adjustable, techno-polymer shell.

Girevole su basamento 5 razze in alluminio pulito con ruote, regolabile in altezza, scocca in tecnopolimero.

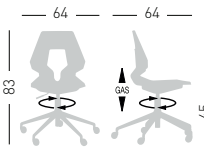

NA not assembled / non assemblato



0,24 m³ - 15 kg.
55x65,5x63 cm
2 pcs [carton]

Frame Finishing & Codes / Finiture Telai e Codici

cod.55.--/5R polished/lucida

DKK - kr

2.195

Sanela

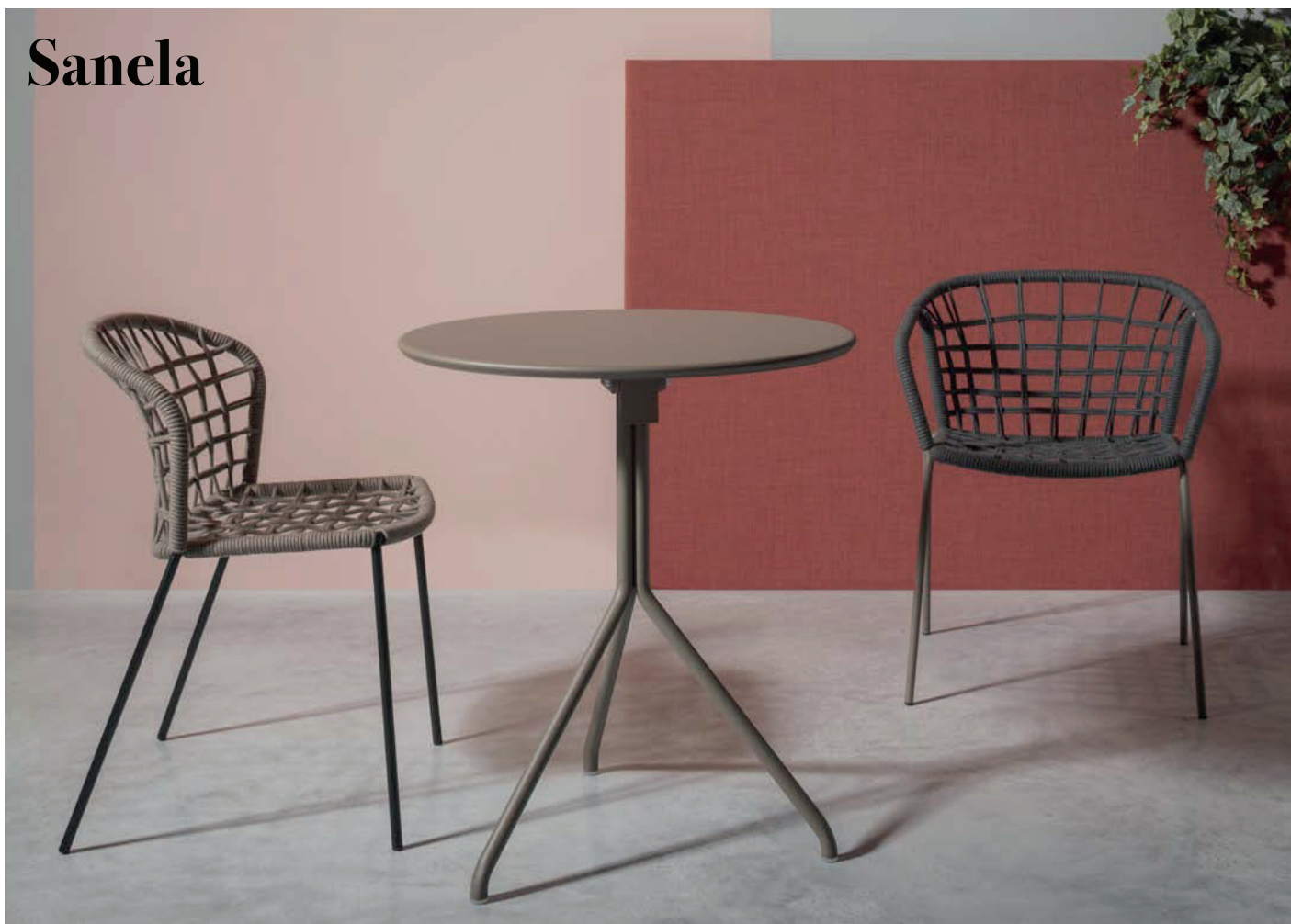

Available rope color / Colori disponibili corda



Frame available colors / Colori disponibili struttura

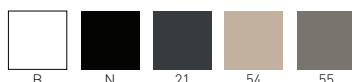

SANELA



4-Legged metal frame, painted with special treatment for outdoor purpose, with wrapped rope.
Telaio 4 gambe in metallo verniciato con trattamento per esterno, con intreccio artigianale di corda.

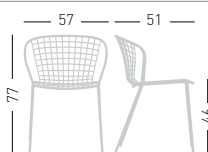

A assembled / assemblato



0,35 m³ - 10,2 kg.
57x63x97cm.
2 pcs [carton]

Frame Finishing & Codes / Finiture Telai e Codici

cod. 270._(I)/A_

DKK - kr

3.895

Min. order 20pcs
each code
Ordine min 20pz
per codice

SANELA B



4-Legged metal frame with armrest, painted with treatment for outdoor purpose, with wrapped rope.
Telaio 4 gambe con braccioli in metallo verniciato con trattamento per esterno, con intreccio artigianale di corda.

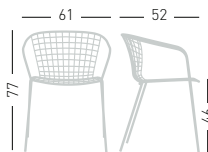

A assembled / assemblato



0,35 m³ - 12 kg.
57x63x97cm.
2 pcs [carton]

Frame Finishing & Codes / Finiture Telai e Codici

cod. 271._(I)/A_

DKK - kr

4.595

Min. order 20pcs
each code
Ordine min 20pz
per codice

SANELA LOUNGE



4-Legged metal lounge armchair, painted with special treatment for outdoor purpose, with wrapped rope. Poltrona lounge con struttura 4 gambe in metallo verniciato con trattamento per esterno, con intreccio artigianale di corda.

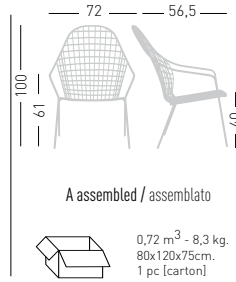

Frame Finishing & Codes / Finiture Telai e Codici

cod. 277_(I)/A_

DKK - kr

9.695

Min. order 10pcs
each code
Ordine min 10pz
per codice

SANELA ROCKING LOUNGE



Relaxing rocking version, featuring rope, wrapped around an aerial metal structure provided with natural oak rockers. Versione a dondolo, realizzata con una struttura aerea in metallo, dall'intreccio artigianale della corda e da pattini in legno di rovere naturale.

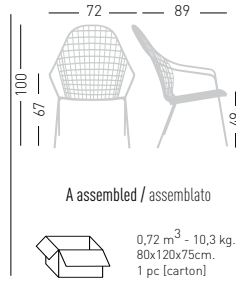

Frame Finishing & Codes / Finiture Telai e Codici

cod. 277_(I)/A_DRN

DKK - kr

11.895

Min. order 10pcs
each code
Ordine min 10pz
per codice

SANELA POUF



Footrest pouf with painted metal structure with outdoor treatment, with wrapped rope. Pouf poggiapiedi con struttura in metallo verniciato con trattamento per esterno, con intreccio artigianale di corda.

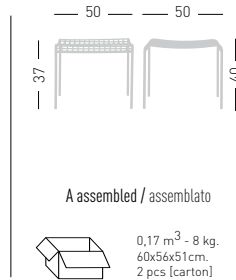

Frame Finishing & Codes / Finiture Telai e Codici

cod. 278_(I)/A_

DKK - kr

2.795

Min. order 10pcs
each code
Ordine min 10pz
per codice

SANELA BENCH



Twin-seater metal bench, painted with special treatment for outdoor purpose, with wrapped rope. Panca 2 posti con struttura in metallo verniciato con trattamento per esterno, con intreccio artigianale di corda.

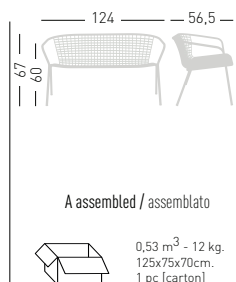

Frame Finishing & Codes / Finiture Telai e Codici

cod. 279_(I)/A_

DKK - kr

12.995

Min. order 10pcs
each code
Ordine min 10pz
per codice

Serena

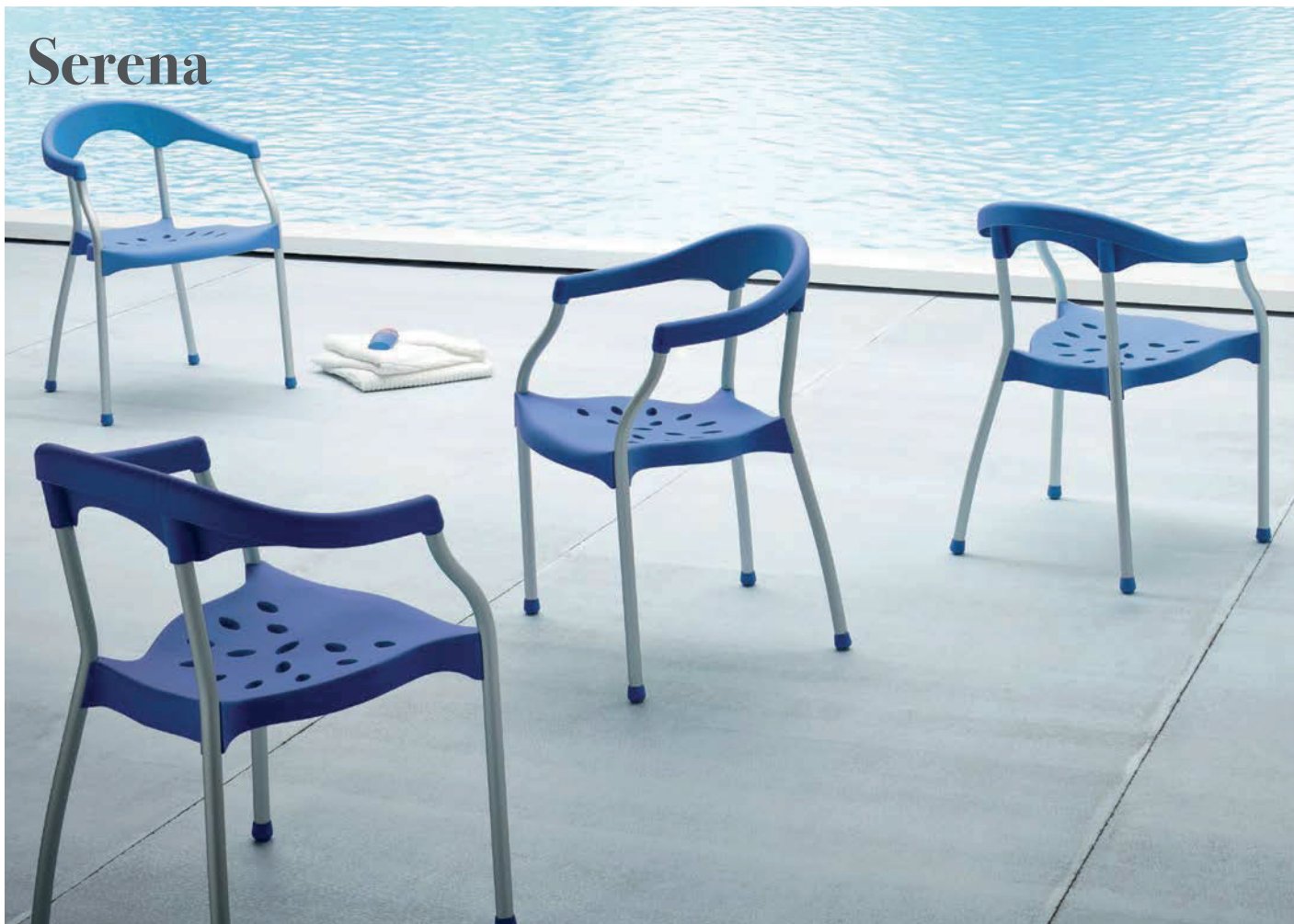

Available colors / Colori disponibili

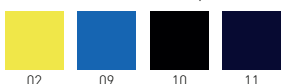

IGN Versions follows UNI 9177 certification in terms of
Fire Resistance, Fire Reaction Class 1
Versioni IGN prodotto Omologato con Classe di Reazione al
fuoco 1, UNI 9177



SERENA

Seat and back in techno-polymer,
anodized aluminum legs.
Seduta e schienale in tecnopolimero e
gambe in alluminio anodizzato.



CATAS
TESTATO - TESTED

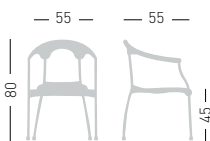

stackable / impilabile (4pcs)

A assembled / assemblato



0,40 m³ - 16,3 kg.
100x66x60cm.
4 pcs [carton]

Frame Finishing & Codes / Finiture Telai e Codici

cod.10.--/A assembled/assemblata
cod.10.--/NA not assembled/non assemblata
cod.10.--/IGN fire retardant / ignifuga

fire retardand minimum 300 pcs
ignifuga minimo 300 pz

NA not assembled / non assemblato



0,13 m³ - 14,3 kg.
33,5x66,5x56cm.
4 pcs [carton]

DKK - kr

995
895
1.295

Slot Fill



Available colors / Colori disponibili

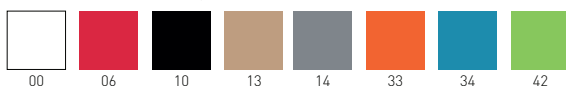

IGN Versions follows UNI 9177 certification in terms of
Fire Resistance, Fire Reaction Class 1
Versioni IGN prodotto Omologato con Classe di Reazione al
fuoco 1, UNI 9177



SLOT FILL NA



Chromed or painted 4-Legged metal frame, techno-polymer shell.
Struttura in metallo 4 gambe, cromata o verniciata, scocca in tecnopolimero.



only for paintend frames
solo per telai verniciati



stackable / impilabile (4pcs)
NA not assembled / non assemblato



0,24 m³ - 21 kg.
55x65,5x63cm.
4 pcs [carton]

Frame Finishing & Codes / Finiture Telai e Codici

cod.174.--/NA chromed/cromata
cod.174.--/NAB white painted/verniciato bianco
cod.174.--/NAN black painted/verniciato nero

DKK - kr

995
1.095
1.095

cod.174.--/IGN

fire retardant, chromed frame
ignifuga, telaio cromato
Minimum order 300pcs/ Ordine minimo 300pz

1.195

SLOT FILL TB



Chromed or painted 4-Legged metal frame with armrests, techno-polymer shell.
Struttura in metallo 4 gambe con braccioli, cromata o verniciata, scocca in tecnopolimero.



only for paintend frames
solo per telai verniciati

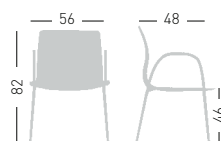

stackable / impilabile (4pcs)
NA not assembled / non assemblato



0,31 m³ - 12,8 kg.
58x53,5x91,5cm.
2 pcs [carton]

Frame Finishing & Codes / Finiture Telai e Codici

cod.174.--/TB chromed/cromata
cod.174.--/TBB white painted/verniciato bianco
cod.174.--/TBN black painted/verniciato nero

DKK - kr

1.395
1.495
1.495

SLOT FILL BL



4-Legged wooden beech frame, techno-polymer shell.
Struttura in legno di faggio 4 gambe, scocca in tecnopolimero.

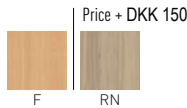

Price + DKK 150

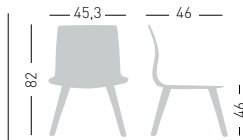

NA not assembled / non assemblato



0,36 m³ - 25,2 kg.
60x56x51cm.
4 pcs [carton]

Frame Finishing & Codes / Finiture Telai e Codici

cod.174.--/BL_

Felt Glides / Tappi in feltro

DKK - kr

1.695

SLOT FILL TC



Chromed or painted wire steel metal frame, techno-polymer shell.
Struttura a traliccio in filo, cromata o verniciata, scocca in tecnopolimero.



only for paintend frames
solo per telai verniciati

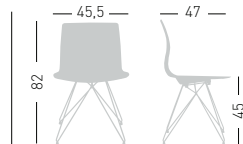

0,3 m³ - 11,6 kg.
48x61x66,5cm.
59,5x56,5x51,5cm.
2 pcs [carton]

Frame Finishing & Codes / Finiture Telai e Codici

cod.174.--/TC chromed/cromata

cod.174.--/TCB white painted/verniciato bianco

cod.174.--/TCN black painted/verniciato nero

DKK - kr

1.295

1.495

1.495

SLOT FILL S



Chromed or painted wire steel sled frame, techno-polymer shell.
Struttura a slitta in filo, cromata o verniciata, scocca in tecnopolimero.



only for paintend frames
solo per telai verniciati

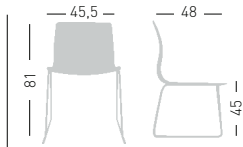

stackable / impilabile (8pcs)

NA not assembled / non assemblato



0,24 m³ - 24,8 kg.
55x65,5x63cm.
4 pcs [carton]

Frame Finishing & Codes / Finiture Telai e Codici

cod.174.--/S chromed/cromata

cod.174.--/SB white painted/verniciato bianco

cod.174.--/SN black painted/verniciato nero

DKK - kr

995

1.095

1.095

SLOT FILL O5R



Swivel on 5-spur polished aluminum base, height adjustable, techno-polymer shell.
Girevole su basamento 5 razze in alluminio pulito, regolabile in altezza, scocca in tecnopolimero.

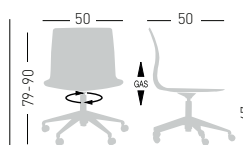

NA not assembled / non assemblato



0,24 m³ - 16,2 kg.
66x55x63cm.
2 pcs [carton]

Frame Finishing & Codes / Finiture Telai e Codici

cod.174.--/O5R polished/lucida

cod.174.--/O5RN black painted/verniciata nera

DKK - kr

1.995

1.995

SLOT FILL U



Swivel on 4-blade aluminum painted base, with glides.
Girevole su basamento verniciato in alluminio a 4 razze su piedini.

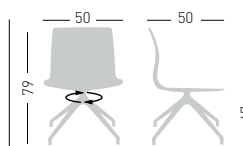

NA not assembled / non assemblato



0,33 m³ - 15,2 kg.
60x56x51cm



62x57x42cm
2 pcs [carton]

Frame Finishing & Codes / Finiture Telai e Codici

cod.174.--/UB white/bianca

cod.174.--/UN black/nera

DKK - kr

2.195

2.195

Felt Glides / Tappi in feltro

SLOT FILL UR



Swivel on 4-blade aluminum painted base, with castors.
Girevole su basamento verniciato in alluminio a 4 razze su ruote.

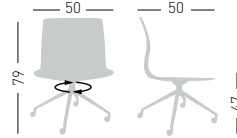

NA not assembled / non assemblato

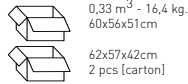

Frame Finishing & Codes / Finiture Telai e Codici

cod.174.--/URB white/bianca
cod.174.--/URN black/nera

DKK - kr

2.295
2.295

SLOT FILL PG



2-3-4-5 seat benches, metal-polymer co-injected legs, techno-polymer shell.
Panca a 2-3-4-5 posti, gambe co-iniettate in metallo-polimero, scocca in tecnopolimero.

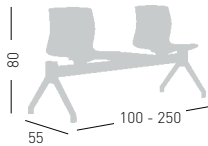

NA not assembled / non assemblato



0,28 m³ - 18,5 kg.
1 pcs [carton]

0,29 m³ - 24 kg.
1 pcs [carton]

0,30 m³ - 28,5 kg.
1 pcs [carton]

0,31 m³ - 34 kg.
1 pcs [carton]

Frame Finishing & Codes / Finiture Telai e Codici

cod.174.--/PG2P-- (100 cm)

cod.174.--/PG3P-- (150 cm)

cod.174.--/PG4P-- (200 cm)

cod.174.--/PG5P-- (250 cm)

DKK - kr

3.595

3.995

4.395

4.795

Legs and shells colors can be combined.
It is possible to change a seat with a grey metal top.
Outdoor version on request.
I colori delle gambe possono essere abbinati alla scocca.
È possibile sostituire la seduta con un tavolino in metallo grigio.
Versione per esterni su richiesta.

SLOT FILL CUSHION / CUSCINO



Upholstered cushion.
Cuscino tappezzato.

Available fabric.
Tessuti disponibili.
B, E, K, DK



0,7 kg
Inside chairs boxes
Inseriti nella scatola delle sedie

Frame Finishing & Codes / Finiture Telai e Codici

cod.308.-- (B)

cod.308.-- (E)

cod.308.-- (K)

cod.308.-- (DK)

cod.308.TC COM fabric/tessuto cliente

DKK - kr

600

550

550

650

475

Fabric required
Fabbisogno di tessuto
4 pcs: Lin Mtrs 1 (h1,40)

COM fabric min. order
10pcs each code
Tessuto cliente TC ordine
min. 10pz per codice

Min. order 4pcs
each code
Ordine min 4pz
per codice

SLOT FILL CONNECTING SYSTEM GANCIO CONNESSIONE



Set linking glides for in-line disposal.
Set piedini con agganci per disporre le sedute in linea.



Inside chairs boxes
Nella scatola delle sedie.

Assembled / assemblato

Frame Finishing & Codes / Finiture Telai e Codici

cod.1012

DKK - kr

125

available for models: S
disponibile per versioni: S

SLOT FILL CHAIRS TROLLEY CARRELLO PER SEDIE



Trolley for chairs, chromed metal structure.
Carrello porta sedie, struttura in metallo cromato.

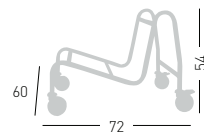

0,3 m³ - 10kg
63x75x58cm.
1 pcs [carton]

Frame Finishing & Codes / Finiture Telai e Codici

cod.2000/A

DKK - kr

2.075

available for models: S
disponibile per versioni: S

stackable on trolley 18 pcs
impilabili su carrello 18 pcs

max height with 18 chairs 188 cm
altezza carrello con 18 sedie 188 cm

SLOT FILL
CHAIRS TROLLEY
CARRELLO PER SEDIE



Painted grey adjustable Dolly, for 4 legged chairs.
Carrello per sedie 4 gambe, regolabile, verniciato grigio.

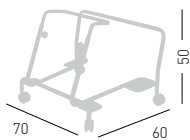

Frame Finishing & Codes / Finiture Telai e Codici

cod.2001/A

available for models: NA
disponibile per versioni: NA

DKK - kr

2.275



0,3 m³ - 8kg
62x72x51cm.
1 pcs [carton]

SLOT UPHOLSTERED IMBOTTITE

Available coverings / Finiture disponibili
 Aurea eco-leather / Ecopelle aurea **E** (4pcs min.)
 King fabric / Tessuto King **K** (4pcs min.)
 Blazer fabric / Tessuto blazer **B** (4pcs min.)
 Kvadrat fabrics / Tessuti Kvadrat **DK** (4pcs min.)
 COM fabric / Tessuto cliente **TC** (10pcs min.)

SLOT M NA UPHOLSTERED



Fabric or leather upholstered chair, chromed or painted frame.
 Sedia imbottita in tessuto o pelle, telaio in metallo cromato o verniciato.

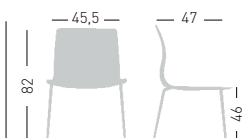

NA not assembled / non assemblato



0,24 m³ - 13 kg.
 55x65,5x63cm.
 2 pcs [carton]

Frame Finishing & Codes / Finiture Telai e Codici

cod.173.--/IENA chromed/cromata
cod.173.--/IENAB white/bianco
cod.173.--/IENAN black/nero
cod.173.--/IKNA chromed/cromata
cod.173.--/IKNAB white/bianco
cod.173.--/IKNAN black/nero
cod.173.--/IBNA chromed/cromata
cod.173.--/IBNAB white/bianco
cod.173.--/IBNAN black/nero
cod.173.--/IDKNA chromed/cromata
cod.173.--/IDKNAB white/bianco
cod.173.--/IDKNAN black/nero
cod.173/ITCNA chromed/cromata
cod.173/ITCNAB white/bianco
cod.173/ITCNAN black/nero

DKK - kr

2.495
2.595
2.595
2.495
2.595
2.595
2.695
2.795
2.795
3.095
3.195
3.195
2.195
2.295
2.295

Fabric required
 Fabbisogno di tessuto
 1 pcs: Lin Mtrs 1,04 (h1,40)

COM fabric min. order
 10pcs each code
 Tessuto cliente TC ordine
 min. 10pz per codice

Min. order 4pcs
 each code
 Ordine min 4pz
 per codice

SLOT M BL UPHOLSTERED



Fabric or leather upholstered chair, wooden beech base.
 Sedia imbottita in tessuto o pelle, telaio in legno di faggio.

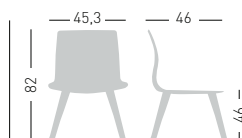

NA not assembled / non assemblato



0,24 m³ - 13 kg.
 55x65,5x63cm.
 2 pcs [carton]

Frame Finishing & Codes / Finiture Telai e Codici

cod.173.--/IEBL_
cod.173.--/IKBL_
cod.173.--/IBBL_
cod.173.--/IDKBL_
cod.173/ITCBL_

DKK - kr

2.795
2.795
3.095
3.295
2.495

Felt Glides / Tappi in feltro
 Fabric required
 Fabbisogno di tessuto
 1 pcs: Lin Mtrs 1,04 (h1,40)

COM fabric min. order
 10pcs each code
 Tessuto cliente TC ordine
 min. 10pz per codice

Min. order 4pcs
 each code
 Ordine min 4pz
 per codice

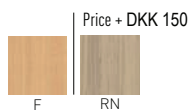

SLOT M TB UPHOLSTERED



Fabric or leather upholstered chair, chromed or painted frame with arms.
 Sedia imbottita in tessuto o pelle, telaio in metallo cromato o verniciato con braccioli.

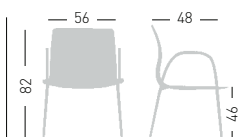

NA not assembled / non assemblato



0,24 m³ - 13,6 kg.
 60x65x75cm.
 2 pcs [carton]

Frame Finishing & Codes / Finiture Telai e Codici

cod.173.--/IETB chromed/cromata
cod.173.--/IETBB white/bianco
cod.173.--/IETBN black/nero
cod.173.--/IKTB chromed/cromata
cod.173.--/IKTBB white/bianco
cod.173.--/IKTBN black/nero
cod.173.--/IBTB chromed/cromata
cod.173.--/IBTBB white/bianco
cod.173.--/IBTBN black/nero
cod.173.--/IDKTB chromed/cromata
cod.173.--/IDKTBB white/bianco
cod.173.--/IDKTBN black/nero
cod.173/ITCTB chromed/cromata
cod.173/ITCTBB white/bianco
cod.173/ITCTBN black/nero

DKK - kr

2.595
2.695
2.695
2.595
2.695
2.695
2.795
2.895
2.895
3.195
3.295
3.295
2.295
2.495
2.495

Fabric required
 Fabbisogno di tessuto
 1 pcs: Lin Mtrs 1,04 (h1,40)

COM fabric min. order
 10pcs each code
 Tessuto cliente TC ordine
 min. 10pz per codice

Min. order 4pcs
 each code
 Ordine min 4pz
 per codice

SLOT M TC UPHOLSTERED



Fabric or leather upholstered chair, chromed or painted frame.
Sedia imbottita in tessuto o pelle, telaio in metallo cromato o verniciato.

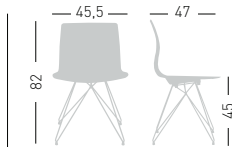

NA not assembled / non assemblato

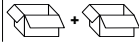

0,3 m³ - 11,6 kg.
48x61x66,5cm.
59,5x56,5x51,5cm.
2 pcs [carton]

Frame Finishing & Codes / Finiture Telai e Codici

cod.173.--/IETC chromed/cromata
cod.173.--/IETCB white/bianco
cod.173.--/IETCN black/nero
cod.173.--/IKTC chromed/cromata
cod.173.--/IKTCB white/bianco
cod.173.--/IKTCN black/nero
cod.173.--/IBTC chromed/cromata
cod.173.--/IBTCB white/bianco
cod.173.--/IBTCN black/nero
cod.173.--/IDKTC chromed/cromata
cod.173.--/IDKTCB white/bianco
cod.173.--/IDKTCN black/nero
cod.173/ITCTC chromed/cromata
cod.173/ITCTCB white/bianco
cod.173/ITCTCN black/nero

DKK - kr

2.595
2.795
2.795
2.995
2.795
2.795
2.895
2.995
2.995
3.295
3.395
3.395
2.395
2.595
2.595

Fabric required
Fabbisogno di tessuto
1 pcs: Lin Mtrs 1,04 (h1,40)

COM fabric min. order
10pcs each code
Tessuto cliente TC ordine
min. 10pz per codice

Min. order 4pcs
each code
Ordine min 4pz
per codice

SLOT M S UPHOLSTERED



Fabric or leather upholstered chair, chromed or painted frame.
Sedia imbottita in tessuto o pelle, telaio in metallo cromato o verniciato.

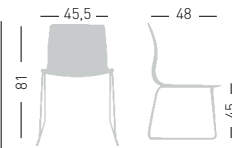

NA not assembled / non assemblato



0,24 m³ - 13 kg.
55x65,5x63cm.
2 pcs [carton]

Frame Finishing & Codes / Finiture Telai e Codici

cod.173.--/IES chromed/cromata
cod.173.--/IESB white/bianco
cod.173.--/IESN black/nero
cod.173.--/IKS chromed/cromata
cod.173.--/IKSB white/bianco
cod.173.--/IKSN black/nero
cod.173.--/IBS chromed/cromata
cod.173.--/IBSB white/bianco
cod.173.--/IBSN black/nero
cod.173.--/IDKS chromed/cromata
cod.173.--/IDKSB white/bianco
cod.173.--/IDKSN black/nero
cod.173/ITCS chromed/cromata
cod.173/ITCSB white/bianco
cod.173/ITCSN black/nero

DKK - kr

2.495
2.595
2.595
2.495
2.595
2.595
2.695
2.795
2.795
3.095
3.195
3.195
2.195
2.295
2.295

Fabric required
Fabbisogno di tessuto
1 pcs: Lin Mtrs 1,04 (h1,40)

COM fabric min. order
10pcs each code
Tessuto cliente TC ordine
min. 10pz per codice

Min. order 4pcs
each code
Ordine min 4pz
per codice

SLOT 05R UPHOLSTERED



Fabric or leather upholstered chair, aluminum polished or painted base.
Sedia imbottita in tessuto o pelle, base in alluminio pulito o verniciato.

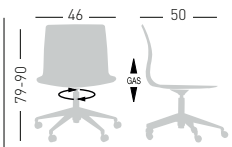

NA not assembled / non assemblato



0,24 m³ - 16,2 kg.
66x55x63cm.
2 pcs [carton]

Frame Finishing & Codes / Finiture Telai e Codici

cod.173.--/IE05R polished/lucida
cod.173.--/IE05RN black painted/verniciata nera
cod.173.--/IK05R polished/lucida
cod.173.--/IK05RN black painted/verniciata nera
cod.173.--/IB05R polished/lucida
cod.173.--/IB05RN black painted/verniciata nera
cod.173.--/IDK05R polished/lucida
cod.173.--/IDK05RN black painted/verniciata nera
cod.173/ITC05R polished/lucida
cod.173/ITC05RN black painted/verniciata nera

DKK - kr

3.295
3.195
3.295
3.195
3.495
3.395
3.895
3.795
2.995
2.895

Fabric required
Fabbisogno di tessuto
1 pcs: Lin Mtrs 1,04 (h1,40)

COM fabric min. order
10pcs each code
Tessuto cliente TC ordine
min. 10pz per codice

Min. order 4pcs
each code
Ordine min 4pz
per codice

**SLOT U
UPHOLSTERED**



Fabric or leather upholstered chair, aluminum polished or painted base.
Sedia imbottita in tessuto o pelle, base in alluminio pulito o verniciato.

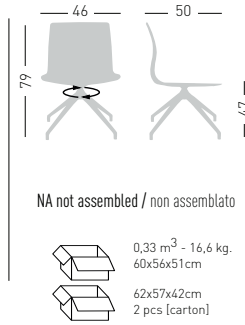

Frame Finishing & Codes / Finiture Telai e Codici

cod.173.--/IEUB white/bianco	DKK - kr	3.595
cod.173.--/IEUN black/nera		3.595
cod.173.--/IEUL polished/lucida		3.695
cod.173.--/IKUB white/bianco		3.595
cod.173.--/IKUN black/nera		3.595
cod.173.--/IKUL polished/lucida		3.695
cod.173.--/IBUB white/bianco		3.795
cod.173.--/IBUN black/nera		3.795
cod.173.--/IBUL polished/lucida		3.895
cod.173.--/IDKUB white/bianco		4.195
cod.173.--/IDKUN black/nera		4.195
cod.173.--/IDKUL polished/lucida		4.295
cod.173/ITCUB white/bianco		3.295
cod.173/ITCUN black/nera		3.295
cod.173/ITCUL polished/lucida		3.395

Felt Glides / Tappi in feltro

Fabric required
Fabbisogno di tessuto
1 pcs: Lin Mtrs 1,04 (h1,40)

COM fabric min. order
10pcs each code
Tessuto cliente TC ordine
min. 10pz per codice

Min. order 4pcs
each code
Ordine min 4pz
per codice

**SLOT UR
UPHOLSTERED**



Fabric or leather upholstered chair, aluminum polished or painted base with castors.
Sedia imbottita in tessuto o pelle, base in alluminio pulito o verniciato con ruote.



Frame Finishing & Codes / Finiture Telai e Codici

cod.173.--/IEURB white/bianco	DKK - kr	3.595
cod.173.--/IEURN black/nera		3.595
cod.173.--/IEURL polished/lucida		3.695
cod.173.--/IKURB white/bianco		3.595
cod.173.--/IKURN black/nera		3.595
cod.173.--/IKURL polished/lucida		3.695
cod.173.--/IBURB white/bianco		3.895
cod.173.--/IBURN black/nera		3.895
cod.173.--/IBURL polished/lucida		3.995
cod.173.--/IDKURB white/bianco		4.195
cod.173.--/IDKURN black/nera		4.195
cod.173.--/IDKURL polished/lucida		4.395
cod.173/ITCURB white/bianco		3.395
cod.173/ITCURN black/nera		3.395
cod.173/ITCURL polished/lucida		3.495

Fabric required
Fabbisogno di tessuto
1 pcs: Lin Mtrs 1,04 (h1,40)

COM fabric min. order
10pcs each code
Tessuto cliente TC ordine
min. 10pz per codice

Min. order 4pcs
each code
Ordine min 4pz
per codice

**SLOT PG
UPHOLSTERED**



Upholstered shell and co-injected metal-polymer legs, painted bench frame.
Sedia con scocca tappezzata e struttura co-iniettata metallo-polimero, telaio panca verniciato.

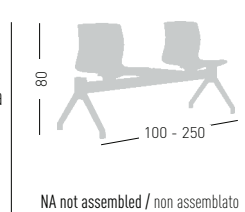

(100 cm)
0,28 m³ - 20 kg.
1 pcs [carton]

(150 cm)
0,29 m³ - 26 kg.
1 pcs [carton]

(200 cm)
0,30 m³ - 31 kg.
1 pcs [carton]

(250 cm)
0,31 m³ - 37 kg.
1 pcs [carton]

Frame Finishing & Codes / Finiture Telai e Codici

cod.173.--/IEPG2P.-- (100 cm)	DKK - kr	6.395
cod.173.--/IEPG3P.-- (150 cm)		6.795
cod.173.--/IEPG4P.-- (200 cm)		7.095
cod.173.--/IEPG5P.-- (250 cm)		7.495
cod.173.--/IKPG2P.-- (100 cm)		6.395
cod.173.--/IKPG3P.-- (150 cm)		6.795
cod.173.--/IKPG4P.-- (200 cm)		7.095
cod.173.--/IKPG5P.-- (250 cm)		7.495
cod.173.--/IBPG2P.-- (100 cm)		6.795
cod.173.--/IBPG3P.-- (150 cm)		7.595
cod.173.--/IBPG4P.-- (200 cm)		8.395
cod.173.--/IBPG5P.-- (250 cm)		9.195
cod.173.--/IDKPG2P.-- (100 cm)		7.695
cod.173.--/IDKPG3P.-- (150 cm)		8.695
cod.173.--/IDKPG4P.-- (200 cm)		9.695
cod.173.--/IDKPG5P.-- (250 cm)		10.595
cod.173/ITCPG2P.-- (100 cm)		5.995
cod.173/ITCPG3P.-- (150 cm)		6.095
cod.173/ITCPG4P.-- (200 cm)		6.195
cod.173/ITCPG5P.-- (250 cm)		6.295

It is possible to change a seat with grey metal top.
È possibile sostituire la seduta con un tavolino grigio in metallo.

Bench legs available colors
Colori disponibili gambe panca
00-06-10-13-14-33-34-42

Fabric required
Fabbisogno di tessuto
1 pcs: Lin Mtrs 1,04 (h1,40)

**SLOT L GL
UPHOLSTERED**



Fabric or leather upholstered shell,
wooden beech base.
Sedia imbottita in tessuto o pelle,
telaio in legno di faggio.

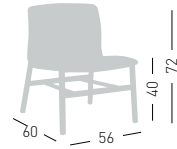

A assembled / assemblato



0,40 m³ - 8,5 kg.
100x66x60cm.
1 pcs [carton]

Frame Finishing & Codes / Finiture Telai e Codici

cod.251.--/IEGLF beech/faggio
cod.251.--/IKGLF beech/faggio
cod.251.--/IBGLF beech/faggio
cod.251.--/IDKGLF beech/faggio
cod.251/ITCGLF beech/faggio

DKK - kr

4.995
4.995
5.395
5.595
4.895

Felt Glides / Tappi in feltro

Fabric required
Fabbisogno di tessuto
1 pcs: Lin Mtrs 1,1 (h1,40)

COM fabric min. order
10pcs each code
Tessuto cliente TC ordine
min. 10pz per codice

Min. order 4pcs
each code
Ordine min 4pz
per codice

**SLOT L S
UPHOLSTERED**



Fabric or leather upholstered shell,
chromed or painted frame.
Sedia imbottita in tessuto o pelle,
telaio in metallo cromato o verniciato.

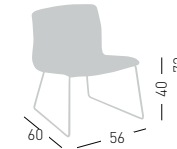

A assembled / assemblato



0,40 m³ - 9,5 kg.
100x66x60cm.
1 pcs [carton]

Frame Finishing & Codes / Finiture Telai e Codici

cod.251.--/IES chromed/cromata
cod.251.--/IESB white/bianco
cod.251.--/IKS chromed/cromata
cod.251.--/IKSB white/bianco
cod.251.--/IBS chromed/cromata
cod.251.--/IBSB white/bianco
cod.251.--/IDKS chromed/cromata
cod.251.--/IDKSB white/bianco
cod.251/ITCS chromed/cromata
cod.251/ITCSB white/bianco

DKK - kr

4.895
4.995
4.895
4.995
5.295

Fabric required
Fabbisogno di tessuto
1 pcs: Lin Mtrs 1,1 (h1,40)

COM fabric min. order
10pcs each code
Tessuto cliente TC ordine
min. 10pz per codice

Min. order 4pcs
each code
Ordine min 4pz
per codice

**SLOT XL GL
UPHOLSTERED**



Fabric or leather upholstered shell,
wooden beech base.
Sedia imbottita in tessuto o pelle,
telaio in legno di faggio.

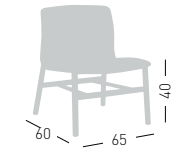

A assembled / assemblato



0,40 m³ - 9 kg.
100x66x60cm.
1 pcs [carton]

Frame Finishing & Codes / Finiture Telai e Codici

cod.252.--/IEGLF beech/faggio
cod.252.--/IKGLF beech/faggio
cod.252.--/IBGLF beech/faggio
cod.252.--/IDKGLF beech/faggio
cod.252/ITCGLF beech/faggio

DKK - kr

5.395
5.395
5.595
5.995
5.295

Felt Glides / Tappi in feltro

Fabric required
Fabbisogno di tessuto
1 pcs: Lin Mtrs 1,1 (h1,40)

COM fabric min. order
10pcs each code
Tessuto cliente TC ordine
min. 10pz per codice

Min. order 4pcs
each code
Ordine min 4pz
per codice

**SLOT XL S
UPHOLSTERED**



Fabric or leather upholstered shell,
chromed or painted frame.
Sedia imbottita in tessuto o pelle,
telaio in metallo cromato o verniciato.

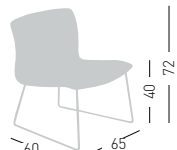

A assembled / assemblato



0,40 m³ - 10,5 kg.
100x66x60cm.
1 pcs [carton]

Frame Finishing & Codes / Finiture Telai e Codici

cod.252.--/IES chromed/cromata
cod.252.--/IESB white/bianco
cod.252.--/IKS chromed/cromata
cod.252.--/IKSB white/bianco
cod.252.--/IBS chromed/cromata
cod.252.--/IBSB white/bianco
cod.252.--/IDKS chromed/cromata
cod.252.--/IDKSB white/bianco
cod.252/ITCS chromed/cromata
cod.252/ITCSB white/bianco

DKK - kr

4.995
5.395
4.995
5.395
5.395

Fabric required
Fabbisogno di tessuto
1 pcs: Lin Mtrs 1,1 (h1,40)

COM fabric min. order
10pcs each code
Tessuto cliente TC ordine
min. 10pz per codice

Min. order 4pcs
each code
Ordine min 4pz
per codice

Social-ize 2027



Frame colors / Colori struttura



SOCIAL-IZE 2027



Modular upholstered seating unit, part of the "2027" system, painted aluminum-steel frame support, techno-polymer and metal co-injected joint.

Seduta imbottita modulare, parte del sistema "2027", telaio di supporto in alluminio e acciaio, giunti in acciaio co-iniettati in tecnopolimero.

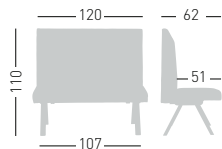

A assembled / assemblato



1,3 m³ - 48 kg.
160x90x85cm.
2 pcs [carton]

Frame Finishing & Codes / Finiture Telai e Codici

cod.264. / IEPK	DKK - kr	11.695
cod.264. / IKPK		11.695
cod.264. / IBPK		13.095
cod.264. / ISPK		13.095
cod.264. / IDKPK		14.195
cod.264. / IPPK		14.195
cod.264. / IMGPK		12.295
cod.264. / ITCPK	COM fabric/tessuto cliente	10.895

Fabric required
Fabbisogno di tessuto
1 pcs: Lin Mtrs 2,5 (h1,40)

COM fabric min. order
10pcs each code
Tessuto cliente TC ordine
min. 10pz per codice

Min. order 2pcs
each code
Ordine min 2pz
per codice

Available coverings / Finiture disponibili
Aurea eco-leather / Ecopelle aurea **E** (2pcs min.)
King fabric / Tessuto King **K** (2pcs min.)
Blazer fabric / Tessuto Blazer **B** (2pcs min.)
Superb Trevira Velvet / Velluto Superb Trevira **S** (2pcs min.)
Kvadrat fabrics / Tessuti Kvadrat **DK** (2pcs min.)
Leather / Pelle **P** (2pcs min.)
Maglia fabric / Tessuto Maglia **MG** (2pcs min.)
COM fabric / Tessuto cliente **TC** (10pcs min.)



Spyker

Available colors / Colori disponibili

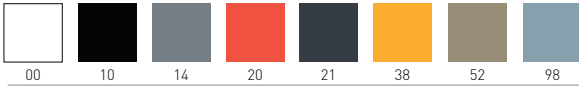

SPYKER

4-legged stackable techno-polymer chair.
Sedia impilabile in tecnopolimero.

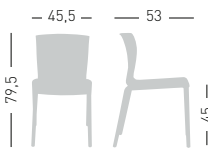

stackable / impilabile (6pcs)
A assembled / assemblato



0,38 m³ - 16,8 kg.
59x75x99cm.
4 pcs [carton]

Frame Finishing & Codes / Finiture Telai e Codici

cod. 225.-- /A

DKK - kr

895

SPYKER B

4-legged stackable techno-polymer chair with armrests.
Sedia impilabile in tecnopolimero con braccioli.

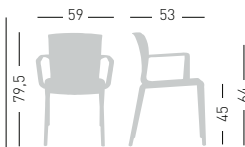

stackable / impilabile (6pcs)
A assembled / assemblato



0,43 m³ - 18,8 kg.
59x75x99cm.
4 pcs [carton]

Frame Finishing & Codes / Finiture Telai e Codici

cod. 226.-- /A

DKK - kr

995

SPYKER CHAIRS TROLLEY CARRELLO PER SEDIE

Trolley for chairs model Spyker,
black painted.
Carrello porta sedie modello Spyker,
verniciato nero.

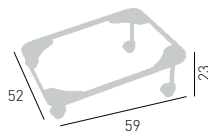

0,09 m³ - 5,5kg
61x54x25cm.
1 pcs [carton]

Frame Finishing & Codes / Finiture Telai e Codici

cod.2002/A

DKK - kr

1.275

Sunlounger Doge

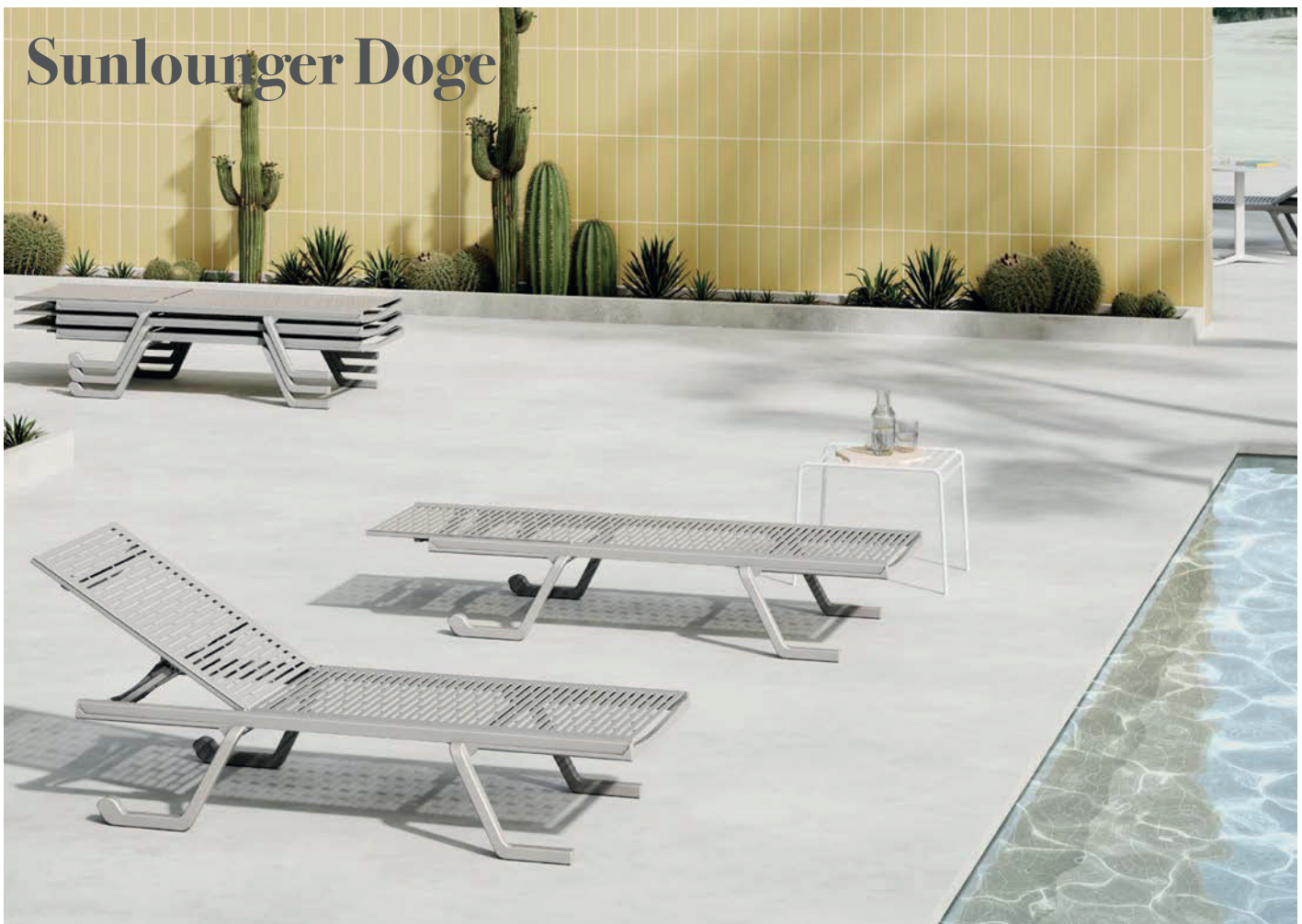

Available colors / Colori disponibili

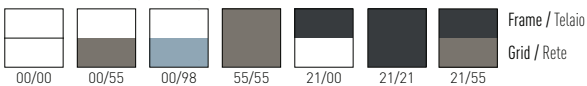

DOGE

Stackable sun lounger, with toughened, co-injected techno-polymer, steel and aluminum frame. High-resistance and flexible techno-polymer-injected slats, casters for ease of manoeuvrability, and back adjustable to five positions.



CATAS
TESTATO - TESTED



Letto prendisole impilabile, con struttura ad alta resistenza in tecnopolimero, acciaio co-iniettato e traversi in alluminio. Maglia flessibile in tecnopolimero traspirante ad alta resistenza, rotelle per trasporto e schienale regolabile in 5 posizioni.

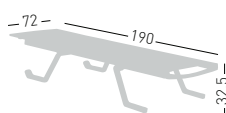

stackable / impilabile

A assembled / assemblato



0,80 m³ - 56 kg.
192x74x55cm.
4 pcs [carton]



3,2 m³ - 333 kg.
192x74x222cm.
24 pcs [pallet]



container 20" 212pcs
container 40" 424pcs

Frame Finishing & Codes / Finiture Telai e Codici

cod.200. __ - __/A
cod.200. __ - __/Al (pallet)

DKK - kr

3.295
2.995

Minimum Order Quantity follows the packaging or multiply each code.
L'ordine minimo per ogni codice è pari all'imballo o multipli dello stesso.

Sunlounger Podio



Available colors / Colori disponibili

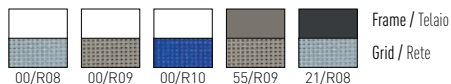

PODIO

Stackable sun lounger, with toughened, co-injected techno-polymer, steel and aluminum frame. High-resistance ventilated mesh, casters for ease of manoeuvrability, and back adjustable to five positions.



Letino prendisole impilabile, con struttura ad alta resistenza in tecnopolimero, acciaio co-iniettato e traversi in alluminio. Maglia in rete traspirante ad alta resistenza, rotelle per trasporto e schienale regolabile in 5 posizioni.

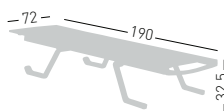

stackable / impilabile

A assembled / assemblato



0,80 m³ - 47 kg.
192x74x55cm.
4 pcs [carton]



3,2 m³ - 280 kg.
192x74x222cm.
24 pcs [pallet]



container 20' 212pcs
container 40' 424pcs

Frame Finishing & Codes / Finiture Telai e Codici

cod.201. __-R_/A
cod.201. __-R_/AI (pallet)

DKK - kr

3.695
3.295

Minimum Order Quantity follows the packaging or multiply each code.
L'ordine minimo per ogni codice è pari all'imballo o multipli dello stesso.

Teckel



Available colors for mesh back
Colori disponibili per schienale in rete

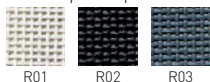

R01 R02 R03

Products follows UNI 9175 -UNI 9175/FA, in terms of Fire Resistance, Fire Reation Class 11M
Prodotto Omologato dal Ministero dell'Interno , secondo la UNI 9175 -UNI 9175/FA, con classe di Reazione al fuoco 11M



Seat available fabric / Tessuti disponibili per sedile
King L fabric / Tessuto King L **L** (4pcs min.)
King fabric / Tessuto King **K** (4pcs min.)
Blazer fabric / Tessuto Blazer **B** (4pcs min.)
Kvadrat fabrics / Tessuti Kvadrat **DK** (4pcs min.)
COM fabric / Tessuto cliente **TC** (10pcs min.)

TECKEL

Black or white painted 4-legged frame, mesh back.
Telaio 4 gambe verniciato nero o bianco, schienale in rete.

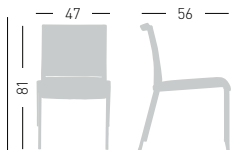

stackable / impilabile (4pcs)
NA not assembled / non assemblato



0,38 m³ - 22 kg.
59x65x99cm.
4 pcs [carton]

Frame Finishing & Codes / Finiture Telai e Codici

cod.800. __-__ /ILNAN black painted/verniciato nero
cod.800. __-__ /ILNAB white painted/verniciato bianco
cod.800. __-__ /IKNAN black painted/verniciato nero
cod.800. __-__ /IKNAB white painted/verniciato bianco
cod.800. __-__ /IBNAN black painted/verniciato nero
cod.800. __-__ /IBNAB white painted/verniciato bianco
cod.800. __-__ /IDKNAN black painted/verniciato nero
cod.800. __-__ /IDKNAB white painted/verniciato bianco
cod.800. __-__ /ITCNAN black painted/verniciato nero
cod.800. __-__ /ITCNAB white painted/verniciato bianco

DKK - kr

2.395
2.395
2.395
2.395
2.495
2.495
2.595
2.595
2.295
2.295

Fabric required
Fabbisogno di tessuto
2 pcs: Lin Mtrs 1 (h1,40)

COM fabric min. order
10pcs each code
Tessuto cliente TC ordine
min. 10pz per codice

Min. order 4pcs
each code
Ordine min 4pz
per codice

TECKEL B

4-legged frame with armrests, mesh back.
Telaio 4 gambe con braccioli, schienale in rete.

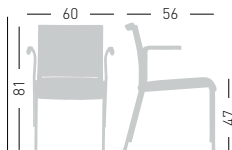

stackable / impilabile (4pcs)
NA not assembled / non assemblato



0,38 m³ - 25 kg.
59x65x99cm.
4 pcs [carton]

Frame Finishing & Codes / Finiture Telai e Codici

cod.801. __-__ /ILNAN black painted/verniciato nero
cod.801. __-__ /ILNAB white painted/verniciato bianco
cod.801. __-__ /IKNAN black painted/verniciato nero
cod.801. __-__ /IKNAB white painted/verniciato bianco
cod.801. __-__ /IBNAN black painted/verniciato nero
cod.801. __-__ /IBNAB white painted/verniciato bianco
cod.801. __-__ /IDKNAN black painted/verniciato nero
cod.801. __-__ /IDKNAB white painted/verniciato bianco
cod.801. __-__ /ITCNAN black painted/verniciato nero
cod.801. __-__ /ITCNAB white painted/verniciato bianco

DKK - kr

2.795
2.795
2.795
2.795
2.895
2.895
2.995
2.995
2.595
2.595

Fabric required
Fabbisogno di tessuto
2 pcs: Lin Mtrs 1 (h1,40)

COM fabric min. order
10pcs each code
Tessuto cliente TC ordine
min. 10pz per codice

Min. order 4pcs
each code
Ordine min 4pz
per codice

TECKEL R



4-legged frame with castors, mesh back.
 Telaio 4 gambe con ruote, schienale in rete.

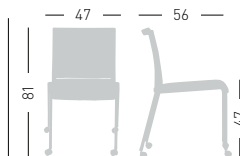

stackable / impilabile (4pcs)
 NA not assembled / non assemblato



0,41 m³ - 22 kg.
 97x73x58cm.
 4 pcs [carton]

Frame Finishing & Codes / Finiture Telai e Codici

cod.800. __-__ /ILNANR black painted/verniciato nero
 cod.800. __-__ /ILNABR white painted/verniciato bianco
 cod.800. __-__ /IKNANR black painted/verniciato nero
 cod.800. __-__ /IKNABR white painted/verniciato bianco
 cod.800. __-__ /IBNANR black painted/verniciato nero
 cod.800. __-__ /IBNABR white painted/verniciato bianco
 cod.800. __-__ /IDKNANR black painted/verniciato nero
 cod.800. __-__ /IDKNABR white painted/verniciato bianco
 cod.800. __-__ /ITCNANR black painted/verniciato nero
 cod.800. __-__ /ITCNABR white painted/verniciato bianco

DKK - kr

2.495
 2.495
 2.495
 2.495
 2.695
 2.695
 2.795
 2.795
 2.495
 2.495

Fabric required
 Fabbisogno di tessuto
 2 pcs: Lin Mtrs 1 (h1,40)

COM fabric min. order
 10pcs each code
 Tessuto cliente TC ordine
 min. 10pz per codice

Min. order 4pcs
 each code
 Ordine min 4pz
 per codice

TECKEL B R



4-legged frame with castors and armrests, mesh back.
 Telaio 4 gambe con ruote e braccioli, schienale in rete.

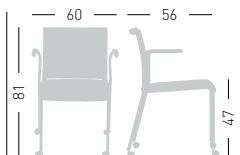

stackable / impilabile (4pcs)
 NA not assembled / non assemblato



0,41 m³ - 25 kg.
 97x73x58cm.
 4 pcs [carton]

Frame Finishing & Codes / Finiture Telai e Codici

cod.801. __-__ /ILNANR black painted/verniciato nero
 cod.801. __-__ /ILNABR white painted/verniciato bianco
 cod.801. __-__ /IKNANR black painted/verniciato nero
 cod.801. __-__ /IKNABR white painted/verniciato bianco
 cod.801. __-__ /IBNANR black painted/verniciato nero
 cod.801. __-__ /IBNABR white painted/verniciato bianco
 cod.801. __-__ /IDKNANR black painted/verniciato nero
 cod.801. __-__ /IDKNABR white painted/verniciato bianco
 cod.801. __-__ /ITCNANR black painted/verniciato nero
 cod.801. __-__ /ITCNABR white painted/verniciato bianco

DKK - kr

2.895
 2.895
 2.895
 2.895
 2.995
 2.995
 3.195
 3.195
 2.795
 2.795

Fabric required
 Fabbisogno di tessuto
 2 pcs: Lin Mtrs 1 (h1,40)

COM fabric min. order
 10pcs each code
 Tessuto cliente TC ordine
 min. 10pz per codice

Min. order 4pcs
 each code
 Ordine min 4pz
 per codice

TECKEL CHAIRS TROLLEY CARRELLO PER SEDIE



Painted grey adjustable Dolly, for 4 legged chairs.
 Carrello per sedie 4 gambe, regolabile, verniciato grigio.

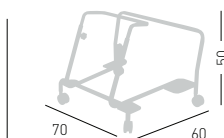

0,3 m³ - 8kg
 62x72x51cm.
 1 pcs [carton]

Frame Finishing & Codes / Finiture Telai e Codici

cod.2001/A

DKK - kr

2.275

available for 4 Legged and 4 Legged with arms version
 disponibile per versione 4 gambe e 4 gambe con braccioli

Together



Available colors / Colori disponibili

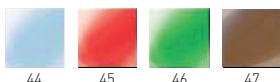

TOGETHER

Techno-polymer shell, oak frame.
Scocca in tecnopolimero, telaio in rovere.



CATAS
TESTATO - TESTED

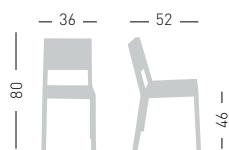

stackable / impilabile (4pcs)

A assembled / assemblato



0,30 m³ - 11,40 kg.
58x53,5x91,5cm.
2 pcs [carton]

Frame Finishing & Codes / Finiture Telai e Codici

cod. 138.-- /A oak/rovere

DKK - kr

3.395



Tulip

Available colors / Colori disponibili



IGN Versions follows UNI 9177 certification in terms of
Fire Resistance, Fire Reaction Class 2
Versioni IGN prodotto Omologato con Classe di Reazione al
fuoco 2, UNI 9177



TULIP



Techno-polymer shell with
anodized aluminum legs.
Scocca in tecnopolimero e gambe in
alluminio anodizzato.

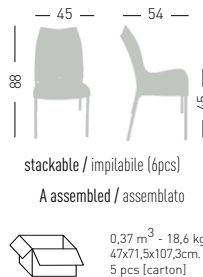

Frame Finishing & Codes / Finiture Telai e Codici

cod.48.--/A assembled/assemblata

DKK - kr

695

cod.48.--/IGN fire retardant/ignifuga
fire retardant minimum 300 pcs
ignifuga minimo 300 pz

995

cod.53.--- dark legs/gamba antracite
minimum 200 pcs/minimo 200 pz

895

TULIP B



Techno-polymer shell with integrated
armrests, anodized aluminum legs.
Scocca in tecnopolimero con braccioli
integrati, gambe in alluminio anodizzato.

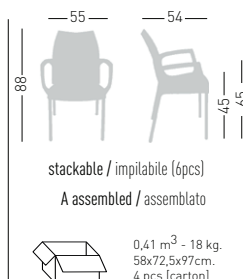

Frame Finishing & Codes / Finiture Telai e Codici

cod.51.--/A assembled/assemblata

DKK - kr

895

cod.51.--/IGN fire retardant/ignifuga
fire retardant minimum 300 pcs
ignifuga minimo 300 pz

1.095

cod.52.--- dark legs/gamba antracite
minimum 200 pcs/minimo 200 pz

995

TULIP CHAIRS TROLLEY CARRELLO PER SEDIE



Trolley for chairs model Tulip,
black painted.
Carrello porta sedie modello Tulip,
verniciato nero.

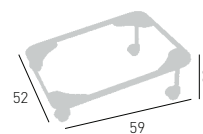

Frame Finishing & Codes / Finiture Telai e Codici

cod.2002/A

DKK - kr

1.275

Venezia



Available coverings / Finiture disponibili
 Aurea eco-leather / Ecopelle aurea **E** (4pcs min.)
 COM fabric / Tessuto cliente **TC** (10pcs min.)

VENEZIA UPHOLSTERED



Techno-polymer upholstered chair in eco-leather.
 Sedia in tecnopolimero imbottita in ecopelle.

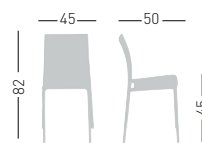

A assembled / assemblato



0,30 m³ - 10,6 kg.
 62,5x46x97cm.
 2 pcs (carton)

Frame Finishing & Codes / Finiture Telai e Codici

cod.30.--/IEA
cod.30/ITCA

DKK - kr

2.095
1.795

Fabric required
 Fabbisogno di tessuto
 1 pcs: Lin Mtrs 1 (h1,40)

COM fabric min. order
 10pcs each code
 Tessuto cliente TC ordine
 min. 10pz per codice

Min. order 4pcs
 each code
 Ordine min 4pz
 per codice

STOOLS Collection

Abuela Stool



Available colors / Colori disponibili

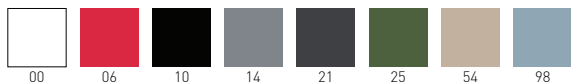

ABUELA STOOL 77 Stackable techno-polymer stool.
Sgabello impilabile in tecnopolimero.



CATAS
TESTATO - TESTED

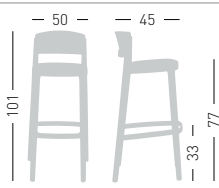

stackable / impilabile (6pcs)
A assembled / assemblato



0,37 m³ - 21 kg.
63x49x118cm.
4 pcs [carton]

Frame Finishing & Codes / Finiture Telai e Codici

cod.294. __/77A

DKK - kr

1.195

ABUELA STOOL 67 Stackable techno-polymer stool.
Sgabello impilabile in tecnopolimero.

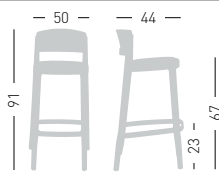

stackable / impilabile (6pcs)
A assembled / assemblato



0,37 m³ - 20 kg.
63x49x118cm.
4 pcs [carton]

Frame Finishing & Codes / Finiture Telai e Codici

cod.294. __/67A

DKK - kr

1.195

ABUELA UPHOLSTERED IMBOTTITI

Available fabric / Tessuti disponibili
King fabric / Tessuto King **K** (20pcs min.)
Kvadrat fabrics / Tessuti Kvadrat - Remix 3 **DK** (20pcs min.)

Steelcut 2 Fabric not available on this product
Tessuto Steelcut 2 non disponibile per questo prodotto

ABUELA LARGE STOOL

Upholstered stool,
wooden beech frame.
Sgabello imbottito,
telaio in legno di faggio.

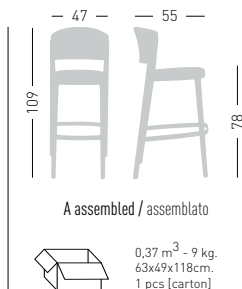

0,37 m³ - 9 kg.
63x49x118cm.
1 pcs [carton]

Frame Finishing & Codes / Finiture Telai e Codici

cod.298.--/IK78BLF
cod.298.--/IDK78BLF

DKK - kr

8.695
9.295

Minimum order 20 pcs each code
Ordine minimo 20 pezzi per codice



Akami

Available colors / Colori disponibili

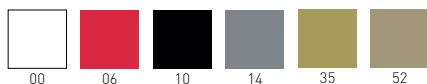

AKAMI ST 75

Techno-polymer seat and chromed or
outdoor painted stackable frame.
Sgabello con seduta in tecnopolimero
e telaio impilabile in metallo cromato
o verniciato per esterno.



only for paintend frames
solo per telai verniciati

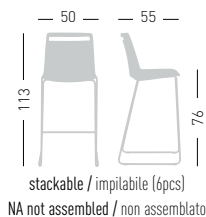

0,47 m³ - 27,0 kg.
59x53x91cm.
60x56x51cm.
4 pcs [carton]

Frame Finishing & Codes / Finiture Telai e Codici

cod. 196.-- /76ST chromed/cromata
cod. 196.-- /76STB white painted/verniciato bianco
cod. 196.-- /76STN black painted/verniciato nero

DKK - kr

1.595
1.795
1.795

AKAMI ST 65



Techno-polymer seat and chromed or outdoor painted stackable frame. Sgabello con seduta in tecnopolimero e telaio impilabile in metallo cromato o verniciato per esterno.



only for paintend frames
solo per telai verniciati

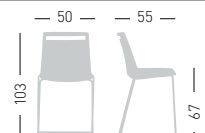

stackable / impilabile (6pcs)
NA not assembled / non assemblato



0,47 m³ - 25,5 kg.
59x53x91cm.
60x56x51cm.
4 pcs [carton]

Frame Finishing & Codes / Finiture Telai e Codici

cod. 196.-- /66ST chromed/cromata
cod. 196.-- /66STB white painted/verniciato bianco
cod. 196.-- /66STN black painted/verniciato nero

DKK - kr

1.595
1.795
1.795

AKAMI CUSHION / CUSCINO



Upholstered cushion.
Cuscino tappezzato.

Available fabric.
Tessuti disponibili.

B, E, K, DK
COM fabric / Tessuto cliente **TC**



0,5 kg.
Inside stools boxes
Nella scatola degli sgabelli.

Frame Finishing & Codes / Finiture Telai e Codici

cod.305.-- (B)
cod.305.-- (E)
cod.305.-- (K)
cod.305.-- (DK)
cod.305.TC COM fabric/tessuto cliente

DKK - kr

625
550
550
650
475

Fabric required
Fabbisogno di tessuto
4 pcs : Lin Mtrs 1 (h1,40)

COM fabric min. order
10pcs each code
Tessuto cliente TC ordine
min. 10pz per codice

Min. order 4pcs
each code
Ordine min 4pz
per codice

AKAMI UPHOLSTERED IMBOTTITI

Available coverings / Finiture disponibili
King fabric / Tessuto King **K** (4pcs min.)
Blazer fabric / Tessuto Blazer **B** (4pcs min.)
Kvadrat fabrics / Tessuti Kvadrat **DK** (4pcs min.)
COM fabric / Tessuto cliente **TC** (10pcs min.)

AKAMI ST 75 UPHOLSTERED



PU-Flex padded and upholstered shell, chromed or painted frame. Sgabello con scocca imbottita in PU-Flex e rivestita, telaio in metallo cromato o verniciato.

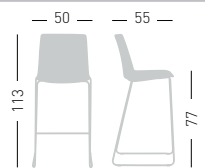

NA not assembled / non assemblato



0,53 m³ - 32,5 kg.
59x53x91cm
66x55x63cm
4 pcs [carton]

Frame Finishing & Codes / Finiture Telai e Codici

cod.196.--/IK76ST chromed/cromata
cod.196.--/IK76STB white/bianco
cod.196.--/IK76STN black/nero
cod.196.--/IB76ST chromed/cromata
cod.196.--/IB76STB white/bianco
cod.196.--/IB76STN black/nero
cod.196.--/IDK76ST chromed/cromata
cod.196.--/IDK76STB white/bianco
cod.196.--/IDK76STN black/nero
cod.196./ITC76ST chromed/cromata
cod.196./ITC76STB white/bianco
cod.196./ITC76STN black/nero

DKK - kr

2.795
2.995
2.995
2.895
3.195
3.195
3.495
3.795
3.795
2.495
2.795
2.795

Fabric required
Fabbisogno di tessuto
1 pcs: Lin Mtrs 1 (h1,40)

COM fabric min. order
10pcs each code
Tessuto cliente TC ordine
min. 10pz per codice

Min. order 4pcs
each code
Ordine min 4pz
per codice

AKAMI ST 65 UPHOLSTERED



PU-Flex padded and upholstered shell, chromed or painted frame. Sgabello con scocca imbottita in PU-Flex e rivestita, telaio in metallo cromato o verniciato.

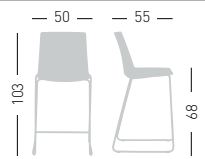

NA not assembled / non assemblato



0,53 m³ - 31,0 kg.
59x53x91cm
66x55x63cm
4 pcs [carton]

Frame Finishing & Codes / Finiture Telai e Codici

cod.196.--/IK66ST chromed/cromata
cod.196.--/IK66STB white/bianco
cod.196.--/IK66STN black/nero
cod.196.--/IB66ST chromed/cromata
cod.196.--/IB66STB white/bianco
cod.196.--/IB66STN black/nero
cod.196.--/IDK66ST chromed/cromata
cod.196.--/IDK66STB white/bianco
cod.196.--/IDK66STN black/nero
cod.196./ITC66ST chromed/cromata
cod.196./ITC66STB white/bianco
cod.196./ITC66STN black/nero

DKK - kr

2.795
2.995
2.995
2.895
3.195
3.195
3.495
3.795
3.795
2.495
2.795
2.795

Fabric required
Fabbisogno di tessuto
1 pcs: Lin Mtrs 1 (h1,40)

COM fabric min. order
10pcs each code
Tessuto cliente TC ordine
min. 10pz per codice

Min. order 4pcs
each code
Ordine min 4pz
per codice



Alhambra

Available colors / Colori disponibili

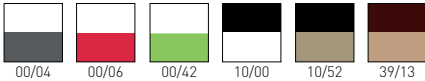

Shell / Scocca
Exagon design / Disegno esagonale

ALHAMBRA 77

Techno-polymer seat, chromed or outdoor painted frame.
Seduta in tecnopolimero, telaio cromato o verniciato per esterno.



only for paintend frames
solo per telai verniciati

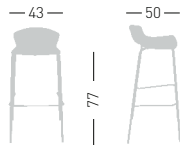

NA not assembled / non assemblato



0,24 m³ - 21,6 kg.
91x59x43cm.
4 pcs [carton]

Frame Finishing & Codes / Finiture Telai e Codici

cod. 98.-- / 77 NA chromed/cromata
cod. 98.-- / 77 NAN black painted/verniciato nero
cod. 98.-- / 77 NAB white painted/verniciato bianco

DKK - kr

1.095
1.195
1.195

ALHAMBRA 67

Techno-polymer seat, chromed or outdoor painted frame.
Seduta in tecnopolimero, telaio cromato o verniciato per esterno.



only for paintend frames
solo per telai verniciati

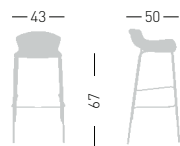

NA not assembled / non assemblato



0,24m³ - 20,4 kg.
91x59x43cm.
4 pcs [carton]

Frame Finishing & Codes / Finiture Telai e Codici

cod. 98.-- / 67 NA chromed/cromata
cod. 98.-- / 67 NAN black painted/verniciato nero
cod. 98.-- / 67 NAB white painted/verniciato bianco

DKK - kr

1.095
1.195
1.195

ALHAMBRA 97A

Techno-polymer seat, chromed frame combined base.
Seduta in tecnopolimero, telaio cromato e base abbinata.

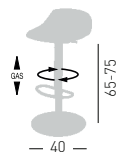

A assembled / assemblato



0,19 m³ - 12 kg.
46x46x89cm.
1 pcs [carton]

Frame Finishing & Codes / Finiture Telai e Codici

cod. 97.-- / A

The base is in the same colour of the seat's back
La base ha lo stesso colore del fondo della seduta

DKK - kr

2.195

ALHAMBRA 97AV



Techno-polymer seat, chromed frame and chromed base.
Seduta in tecnopolimero, telaio cromato e base cromata.

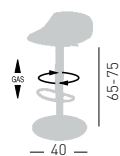

A assembled / assemblato



0,19 m³ - 12,5 kg.
46x46x89 cm.
1 pcs [carton]

Frame Finishing & Codes / Finiture Telai e Codici

cod. 97.-- /AV chromed base/base cromata

DKK - kr

2.495

ALHAMBRA ST 76



Techno-polymer seat and chromed or outdoor painted stackable frame.
Sgabello con seduta in tecnopolimero e telaio impilabile in metallo cromato o verniciato per esterno.



only for paintend frames
solo per telai verniciati

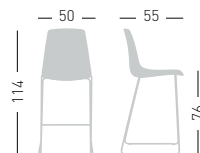

stackable / impilabile (6pcs)

NA not assembled / non assemblato



0,47 m³ - 28,4 kg.
59x53x91 cm.
60x56x51 cm.
4 pcs [carton]

Frame Finishing & Codes / Finiture Telai e Codici

cod.192.--/76ST chromed/cromata

cod.192.--/76STB white painted/verniciato bianco

cod.192.--/76STN black painted/verniciato nero

DKK - kr

1.495

1.795

1.795

ALHAMBRA ST 66



Techno-polymer seat and chromed or outdoor painted stackable frame.
Sgabello con seduta in tecnopolimero e telaio impilabile in metallo cromato o verniciato per esterno.



only for paintend frames
solo per telai verniciati

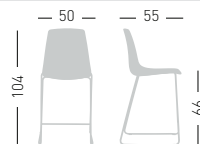

stackable / impilabile (6pcs)

NA not assembled / non assemblato



0,47 m³ - 27,0 kg.
59x53x91 cm.
60x56x51 cm.
4 pcs [carton]

Frame Finishing & Codes / Finiture Telai e Codici

cod.192.--/66ST chromed/cromata

cod.192.--/66STB white painted/verniciato bianco

cod.192.--/66STN black painted/verniciato nero

DKK - kr

1.495

1.795

1.795

ALHAMBRA UPHOLSTERED IMBOTTITI

Available coverings / Finiture disponibili
Aurea eco-leather / Ecopelle aurea **E** (4pcs min.)
King fabric / Tessuto King **K** (4pcs min.)
Blazer fabric / Tessuto Blazer **B** (4pcs min.)
COM fabric / Tessuto cliente **TC** (10pcs min.)

DRESS ALHAMBRA 77



Upholstered techno-polymer shell,
chromed or paintend frame.
Scocca in tecnopolimero rivestito,
telaio cromato o verniciato

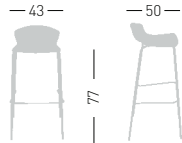

NA not assembled / non assemblato



0,24 m³ - 13,5 kg.
91x59x43cm.
2 pcs [carton]

Frame Finishing & Codes / Finiture Telai e Codici

cod.98.--/IE77NA chromed/cromato
cod.98.--/IE77NAB white/bianco
cod.98.--/IE77NAN black/nero

DKK - kr

2.295

2.495

2.495

cod.98.--/IK77NA chromed/cromato
cod.98.--/IK77NAB white/bianco
cod.98.--/IK77NAN black/nero

2.295

2.495

2.495

cod.98.--/IB77NA chromed/cromato
cod.98.--/IB77NAB white/bianco
cod.98.--/IB77NAN black/nero

2.495

2.595

2.595

cod.98./ITC77NA chromed/cromato
cod.98./ITC77NAB white/bianco
cod.98./ITC77NAN black/nero

2.195

2.395

2.395

Fabric required
Fabbisogno di tessuto
1 pcs: Lin Mtrs 0,5 (h1,40)

COM fabric min. order
10pcs each code
Tessuto cliente TC ordine
min. 10pz per codice

Min. order 4pcs
each code
Ordine min 4pz
per codice

DRESS ALHAMBRA 67



Upholstered techno-polymer shell,
chromed or paintend frame.
Scocca in tecnopolimero rivestito,
telaio cromato o verniciato

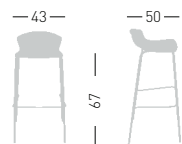

NA not assembled / non assemblato



0,24 m³ - 13 kg.
91x59x43cm.
2 pcs [carton]

Frame Finishing & Codes / Finiture Telai e Codici

cod.98.--/IE67NA chromed/cromato
cod.98.--/IE67NAB white/bianco
cod.98.--/IE67NAN black/nero

DKK - kr

2.295

2.495

2.495

cod.98.--/IK67NA chromed/cromato
cod.98.--/IK67NAB white/bianco
cod.98.--/IK67NAN black/nero

2.395

2.495

2.495

cod.98.--/IB67NA chromed/cromato
cod.98.--/IB67NAB white/bianco
cod.98.--/IB67NAN black/nero

2.495

2.595

2.595

cod.98./ITC67NA chromed/cromato
cod.98./ITC67NAB white/bianco
cod.98./ITC67NAN black/nero

2.195

2.395

2.395

Fabric required
Fabbisogno di tessuto
1 pcs: Lin Mtrs 0,5 (h1,40)

COM fabric min. order
10pcs each code
Tessuto cliente TC ordine
min. 10pz per codice

Min. order 4pcs
each code
Ordine min 4pz
per codice

DRESS ALHAMBRA 97 A



Upholstered techno-polymer seat and chromed frame.
Sgabello con seduta in tecnopolimero rivestito e telaio in metallo cromato

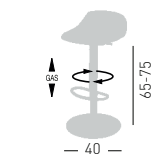

A assembled / assemblato



Frame Finishing & Codes / Finiture Telai e Codici

cod.97.--/IEA
cod.97.--/IKA
cod.97/ITCA
cod.97.--/IBA

DKK - kr

3.495
3.395
3.395
3.195

Fabric required
Fabbisogno di tessuto
1 pcs: Lin Mtrs 0,5 (h1,40)

COM fabric min. order
10pcs each code
Tessuto cliente TC ordine
min. 10pz per codice

Min. order 4pcs
each code
Ordine min 4pz
per codice

DRESS ALHAMBRA 97 AV



Upholstered techno-polymer seat and chromed frame.
Sgabello con seduta in tecnopolimero rivestito e telaio in metallo cromato

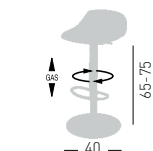

A assembled / assemblato

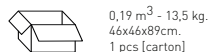

Frame Finishing & Codes / Finiture Telai e Codici

cod.97.--/IEAV
cod.97.--/IKAV
cod.97/ITCAV
cod.97.--/IBAV

DKK - kr

3.695
3.595
3.595
3.495

Fabric required
Fabbisogno di tessuto
1 pcs: Lin Mtrs 0,5 (h1,40)

COM fabric min. order
10pcs each code
Tessuto cliente TC ordine
min. 10pz per codice

Min. order 4pcs
each code
Ordine min 4pz
per codice

DRESS ALHAMBRA ST 76



Upholstered techno-polymer seat, chromed or painted frame.
Sgabello con seduta in tecnopolimero rivestito e telaio in metallo cromato o verniciato.

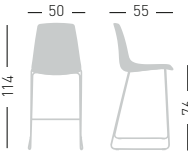

NA not assembled / non assemblato

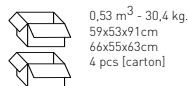

Frame Finishing & Codes / Finiture Telai e Codici

cod.192.--/IE76ST chromed/cromata
cod.192.--/IE76STB white/bianco
cod.192.--/IE76STN black/nero
cod.192.--/IK76ST chromed/cromata
cod.192.--/IK76STB white/bianco
cod.192.--/IK76STN black/nero
cod.192.--/IB76ST chromed/cromata
cod.192.--/IB76STB white/bianco
cod.192.--/IB76STN black/nero
cod.192/ITC76ST chromed/cromata
cod.192/ITC76STB white/bianco
cod.192/ITC76STN black/nero

DKK - kr

2.495
2.795
2.795
2.495
2.795
2.795
2.595
2.895
2.895
2.395
2.695
2.695

Fabric required
Fabbisogno di tessuto
1 pcs: Lin Mtrs 1 (h1,40)

COM fabric min. order
10pcs each code
Tessuto cliente TC ordine
min. 10pz per codice

Min. order 4pcs
each code
Ordine min 4pz
per codice

DRESS ALHAMBRA ST 66



Upholstered techno-polymer seat, chromed or painted frame.
Sgabello con seduta in tecnopolimero rivestito e telaio in metallo cromato o verniciato.

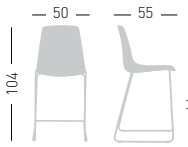

NA not assembled / non assemblato

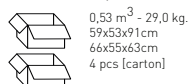

Frame Finishing & Codes / Finiture Telai e Codici

cod.192.--/IE66ST chromed/cromata
cod.192.--/IE66STB white/bianco
cod.192.--/IE66STN black/nero
cod.192.--/IK66ST chromed/cromata
cod.192.--/IK66STB white/bianco
cod.192.--/IK66STN black/nero
cod.192.--/IB66ST chromed/cromata
cod.192.--/IB66STB white/bianco
cod.192.--/IB66STN black/nero
cod.192/ITC66ST chromed/cromata
cod.192/ITC66STB white/bianco
cod.192/ITC66STN black/nero

DKK - kr

2.495
2.795
2.795
2.495
2.795
2.795
2.595
2.895
2.895
2.395
2.695
2.695

Fabric required
Fabbisogno di tessuto
1 pcs: Lin Mtrs 1 (h1,40)

COM fabric min. order
10pcs each code
Tessuto cliente TC ordine
min. 10pz per codice

Min. order 4pcs
each code
Ordine min 4pz
per codice

Amitha Stool



Available colors / Colori disponibili



AMITHA STOOL



4-Legged metal stool, painted with special treatment for outdoor purpose.
Sgabello con struttura 4 gambe in metallo verniciato con trattamento per esterno.

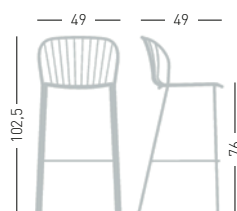

stackable / impilabile (4pcs)
A assembled / assemblato



0,43 m³ - 22 kg.
60x59x116cm.
2 pcs (carton)

Frame Finishing & Codes / Finiture Telai e Codici

cod. 80. __/A

DKK - kr

2.195

Min. order 4pcs
each code
Ordine min 4pz
per codice

AMITHA STOOL CUSHION / CUSCINO



Cushion with removable cover, suitable for outdoor purpose; high density bielastic rubber padding, stitching made with raised edge. The cushion is fixed to the stool by Velcro straps.
Cuscino sfoderabile, adatto ad uso per esterni; imbottiture in gomma bielastica ad alta densità, cucitura realizzata con bordino in rilievo riportato. Il cuscino si fissa allo sgabello per mezzo di fascette in Velcro.



0,6 kg
Inside chairs boxes
Inseriti nella
scatola delle sedie

Frame Finishing & Codes / Finiture Telai e Codici

cod. 339.-- (MG)

cod. 339.-- (SX)

DKK - kr

675

675

Min. order 4pcs
each code
Ordine min 4pz
per codice

Available fabric.
Tessuti disponibili.

MG, SX

Artesia Stool



IGN Versions follows UNI 9177 certification in terms of Fire Resistance, Fire Reaction Class 1
Versioni IGN prodotto Omologato con Classe di Reazione al fuoco 1, UNI 9177



Available Shell Color / Colori disponibili Scocca

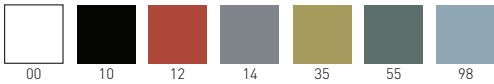

Frame Finishes / Finiture telaio

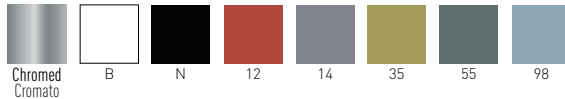

ARTESIA STOOL 75

Stool made with a techno-polymer seat and a wire steel stackable frame.
Sgabello con seduta in tecnopolimero e telaio impilabile in tondino metallico.

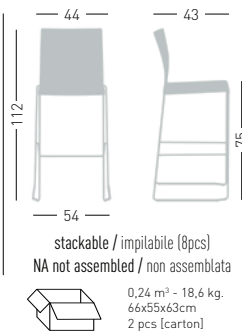

Frame Finishing & Codes / Finiture Telai e Codici

cod. 112.__/75S chromed/cromata	DKK - kr	1.495
cod. 112.__/75SB white painted/verniciato bianco		1.495
cod. 112.__/75SN black painted/verniciato nero		1.495
cod. 112.__/75S55 mineral grey painted/verniciato grigio minerale		1.695
cod. 112.__/75S14 pearl grey painted/verniciato grigio perla		1.695
cod. 112.__/75S12 brick painted/verniciato mattone		1.695
cod. 112.__/75S35 lime painted/verniciato lime		1.695
cod. 112.__/75S98 pale blue painted/verniciato avio		1.695
cod. 112.00/IGN75S-- Fire Retardant/Ignifuga Classe 1		1.795
cod. 112.55/IGN75S-- Fire Retardant/Ignifuga Classe 1		1.795
cod. 112.14/IGN75S-- Fire Retardant/Ignifuga Classe 1		1.795
cod. 112.98/IGN75S-- Fire Retardant/Ignifuga Classe 1		1.795

Minimum order 4pcs each code
Ordine minimo 4 pezzi per codice

Fire Retardant minimum Order 20pcs
Ignifuga ordine Minimo 20pz

Black glides on black frames.
Neutral glides on other frame finishes.
Piedini neri su telai neri.
Piedini neutri nelle altre finiture telai.

ARTESIA STOOL
NARROW CUSHION /
CUSCINO STRETTO



Narrow upholstered cushion,
suitable for stool stackability.
Cuscino tappezzato stretto, adatto
a sgabelli che devono essere impilati.

Available fabric.
Tessuti disponibili.

B, E, K, DK
COM fabric / Tessuto cliente **TC** (10 pcs min)



0,450kg/pz
Inside chairs boxes
Inseriti nella
scatola delle sedie

Frame Finishing & Codes / Finiture Telai e Codici

cod.330.-- (B)
cod.330.-- (E)
cod.330.-- (K)
cod.330.-- (DK)
cod.330.TC COM fabric/tessuto cliente

DKK - kr

650
550
550
650
475

Fabric required
Fabbisogno di tessuto
4 pcs: Lin Mtrs 1,0 (h1,40)

COM fabric min. order
10pcs each code
Tessuto cliente TC ordine
min. 10pz per codice

Min. order 4pcs
each code
Ordine min 4pz
per codice

ARTESIA STOOL
WIDE CUSHION /
CUSCINO LARGO



Large upholstered cushion.
Cuscino tappezzato largo.

Available fabric.
Tessuti disponibili.

B, E, K, DK
COM fabric / Tessuto cliente **TC**
(10 pcs min)



0,500kg/pz
Inside chairs boxes
Inseriti nella
scatola delle sedie

Frame Finishing & Codes / Finiture Telai e Codici

cod.331.-- (B)
cod.331.-- (E)
cod.331.-- (K)
cod.331.-- (DK)
cod.331.TC COM fabric/tessuto cliente

DKK - kr

650
550
550
675
475

Fabric required
Fabbisogno di tessuto
4 pcs: Lin Mtrs 1,2 (h1,40)

COM fabric min. order
10pcs each code
Tessuto cliente TC ordine
min. 10pz per codice

Min. order 4pcs
each code
Ordine min 4pz
per codice



Available coverings / Finiture disponibili
Leather / Cuoio **C** (4pcs min.)

ASOLO
UPHOLSTERED



Techno-polymer seat upholstered
in leather, chromed frame and base.
Seduta in tecnopolimero rivestito cuoio,
telai e base cromati.

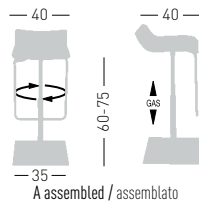

0,13 m³ - 11 kg.
42x42x77,5cm.
1 pcs (carton)

Frame Finishing & Codes / Finiture Telai e Codici

cod.59.--/ICA

DKK - kr

2.895

Min. order 4pcs
each code
Ordine min 4pz
per codice

Bakhita



Available colors / Colori disponibili



IGN Versions follows UNI 9177 certification in terms of
Fire Resistance, Fire Reaction Class 1
Versioni IGN prodotto Omologato con Classe di Reazione al
fuoco 1, UNI 9177



BAKHITA 76

Co-injected metal-polymer
stackable stool.
Sgabello impilabile in co-iniezione
polimero-metallo.



CATAS
TESTATO - TESTED

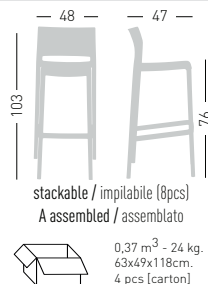

Frame Finishing & Codes / Finiture Telai e Codici

cod.372.--/76A

DKK - kr

1.195

cod.372.--/76IGN fire retardant/ignifugo
Minimum order 300pcs/ Ordine minimo 300pcs

1.595

BAKHITA 66

Co-injected metal-polymer
stackable stool.
Sgabello impilabile in co-iniezione
polimero-metallo.

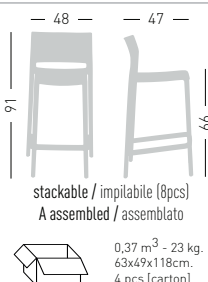

Frame Finishing & Codes / Finiture Telai e Codici

cod.372.--/66A

DKK - kr

1.195

cod.372.--/66IGN fire retardant/ignifugo
Minimum order 300pcs/ Ordine minimo 300pcs

1.595

BAKHITA CUSHION / CUSCINO

Upholstered cushion.
Cuscino tappezzato.



Available fabric.
Tessuti disponibili.
B, E, K, DK, TC



0,4 kg
Inside stools boxes
Netta scatola degli
sgabelli

Frame Finishing & Codes / Finiture Telai e Codici

cod. 314.-- (B)

DKK - kr

600

cod. 314.-- (E)

550

cod. 314.-- (K)

550

cod. 314.--(DK)

650

cod.314.TC COM fabric/tessuto cliente

475

Fabric required
Fabbisogno di tessuto
4 pcs : Lin Mtrs 1 (h1,40)

COM fabric min. order
10pcs each code
Tessuto cliente TC ordine
min. 10pz per codice

Min. order 4pcs
each code
Ordine min 4pz
per codice



Available colors / Colori disponibili

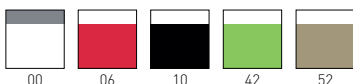

BLOG 78



Techno-polymer seat, chromed or outdoor painted frame.
Seduta in tecnopolimero, telaio cromato o verniciato per esterno.



only for painted frames
solo per telai verniciati

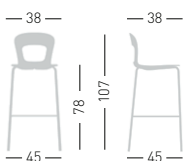

stackable / impilabile (4pcs)
NA not assembled / non assemblato



0,240 m³ - 22 kg.
91x59x43cm.
4 pcs [carton]

Frame Finishing & Codes / Finiture Telai e Codici

cod. 145.-- / 78 NA chromed/cromata
cod. 145.-- / 78 NAB white painted/verniciato bianco
cod. 145.-- / 78 NAN black painted/verniciato nero

DKK - kr

1.395
1.495
1.495

BLOG 68



Techno-polymer seat, chromed or outdoor painted frame.
Seduta in tecnopolimero, telaio cromato o verniciato per esterno.



only for painted frames
solo per telai verniciati

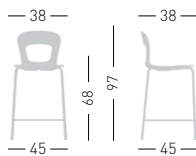

stackable / impilabile (4pcs)
NA not assembled / non assemblato



0,240 m³ - 21 kg.
91x59x43cm.
4 pcs [carton]

Frame Finishing & Codes / Finiture Telai e Codici

cod. 145.-- / 68 NA chromed/cromata
cod. 145.-- / 68 NAB white painted/verniciato bianco
cod. 145.-- / 68 NAN black painted/verniciato nero

DKK - kr

1.395
1.495
1.495

BLOG 145A

Techno-polymer seat,
chromed frame and combined base.
Seduta in tecnopolimero, telaio
cromato e base abbinata.

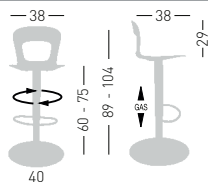

A assembled / assemblato



0,19 m³ - 11,5 kg.
46x46x89cm.
1 pcs (carton)

Frame Finishing & Codes / Finiture Telai e Codici

cod. 145.-- /A

Base color combined with the seat
Colore base abbinato alla seduta

DKK - kr

2.795

BLOG 145AV

Techno-polymer seat,
chromed frame and chromed base.
Seduta in tecnopolimero, telaio
cromato e base cromata.

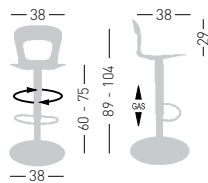

A assembled / assemblato



0,19 m³ - 12 kg.
46x46x89cm.
1 pcs (carton)

Frame Finishing & Codes / Finiture Telai e Codici

cod.145.--/AV chromed base/base cromata

DKK - kr

3.095

BLOG UPHOLSTERED IMBOTTITI

Available coverings / Finiture disponibili
Leather / Pelle **P** (4pcs min.)
King fabric / Tessuto King **K** (4pcs min.)

**BLOG 78
UPHOLSTERED**

Upholstered fabric or leather seat and
chromed or painted metal frame.
Seduta in tessuto o pelle, telaio in
metallo cromato o verniciato.

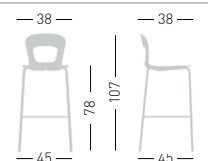

NA not assembled / non assemblato



0,240 m³ - 24 kg.
91x59x43cm.
4 pcs (carton)

Frame Finishing & Codes / Finiture Telai e Codici

cod.145.--/IP78NA chromed/cromata

cod.145.--/IP78NAB white/bianco

cod.145.--/IP78NAN black/nero

cod.145.--/IK78NA chromed/cromata

cod.145.--/IK78NAB white/bianco

cod.145.--/IK78NAN black/nero

DKK - kr

3.395

3.595

3.595

2.895

2.995

2.995

Min. order 4pcs
each code
Ordine min 4pz
per codice

**BLOG 68
UPHOLSTERED**

Upholstered fabric or leather seat and
chromed or painted metal frame.
Seduta in tessuto o pelle, telaio in
metallo cromato o verniciato.

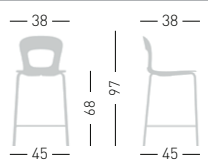

NA not assembled / non assemblato



0,240 m³ - 22,8 kg.
91x59x43cm.
4 pcs (carton)

Frame Finishing & Codes / Finiture Telai e Codici

cod.145.--/IP68NA chromed/cromata

cod.145.--/IP68NAB white/bianco

cod.145.--/IP68NAN black/nero

cod.145.--/IK68NA chromed/cromata

cod.145.--/IK68NAB white/bianco

cod.145.--/IK68NAN black/nero

DKK - kr

3.395

3.595

3.595

2.895

2.995

2.995

Min. order 4pcs
each code
Ordine min 4pz
per codice

BLOG 145A
UPHOLSTERED



Upholstered fabric or leather seat, chromed metal frame and combined base.
Seduta in tessuto o pelle. Telaio metallo cromato e base abbinata.

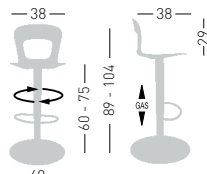

A assembled / assemblato



0,19 m³ - 12 kg.
46x46x89cm.
1 pcs (carton)

Frame Finishing & Codes / Finiture Telai e Codici

cod.145.--/IPA
cod.145.--/IKA

DKK - kr

4.495
3.995

Min. order 4pcs
each code
Ordine min 4pz
per codice

BLOG 145A
UPHOLSTERED



Fabric or leather seat, chromed metal frame and base.
Seduta in tessuto o pelle.
Telaio e base in metallo cromato.

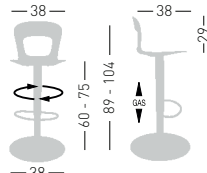

A assembled / assemblato



0,19 m³ - 12,5 kg.
46x46x89cm.
1 pcs (carton)

Frame Finishing & Codes / Finiture Telai e Codici

cod.145.--/IPAV chromed base/base cromata
cod.145.--/IKAV chromed base/base cromata

DKK - kr

4.795
4.195

Min. order 4pcs
each code
Ordine min 4pz
per codice



Citro

Available colors / Colori disponibili

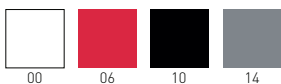

CITRO



Techno-polymer seat, chromed frame and combined base.
Seduta in tecnopolimero,
telaio cromato e base abbinata.

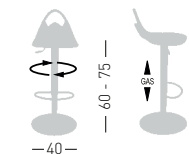

A assembled / assemblato



0,19 m³ - 11 kg.
46x46x89cm.
1 pcs (carton)

Frame Finishing & Codes / Finiture Telai e Codici

cod. 33.-- /A

DKK - kr

2.095

Base color combined with the seat
Colore base abbinato alla seduta

CITRO AV



Techno-polymer seat, chromed frame and chromed base.
Seduta in tecnopolimero, telaio cromato e base cromata.

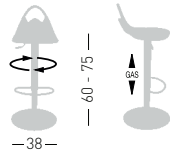

A assembled / assemblato



0,19 m³ - 11,5 kg.
46x46x89cm
1 pcs [carton]

Frame Finishing & Codes / Finiture Telai e Codici

cod.33.--/AV chromed base/base cromata

DKK - kr

2.295

Colorfive



Available colors / Colori disponibili

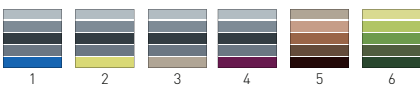

COLORFIVE ST 76

Techno-polymer seat and chromed or outdoor painted stackable frame.
Sgabello con seduta in tecnopolimero e telaio impilabile in metallo cromato o verniciato per esterno.



only for paintend frames
solo per telai verniciati

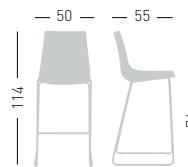

stackable / impilabile (6pcs)
NA not assembled / non assemblato



0,47 m³ - 28,4 kg.
59x53x91cm.
60x56x51cm.
4 pcs [carton]

Frame Finishing & Codes / Finiture Telai e Codici

cod.235.--/76ST chromed/cromata
cod.235.--/76STB white/bianco
cod.235.--/76STN black/nero

DKK - kr

2.395

2.595

2.595

COLORFIVE ST 66



Techno-polymer seat and chromed or outdoor painted stackable frame. Sgabello con seduta in tecnopolimero e telaio impilabile in metallo cromato o verniciato per esterno.



only for painted frames
solo per telai verniciati



stackable / impilabile (6pcs)
NA not assembled / non assemblato



0,47 m³ - 27,0 kg.
59x53x91cm.
60x56x51cm.
4 pcs [carton]

Frame Finishing & Codes / Finiture Telai e Codici

cod.235.--/66ST chromed/cromata
cod.235.--/66STB white/bianco
cod.235.--/66STN black/nero

DKK - kr

2.395
2.595
2.595

COLORFIVE UPHOLSTERED IMBOTTITI

Available coverings / Finiture disponibili
Aurea eco-leather / Ecopelle aurea **E** (4pcs min.)
King fabric / Tessuto King **K** (4pcs min.)
Blazer fabric / Tessuto Blazer **B** (4pcs min.)
COM fabric / Tessuto cliente **TC** (10pcs min.)

COLORFIVE WRAP ST 76



Upholstered Techno-polymer seat and chromed or painted frame. Sgabello con seduta in tecnopolimero rivestito e telaio in metallo cromato o verniciato.

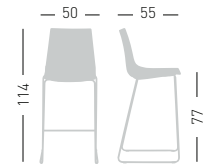

NA not assembled / non assemblato



0,53 m³ - 30,4 kg.
59x53x91cm
66x55x63cm
4 pcs [carton]

Frame Finishing & Codes / Finiture Telai e Codici

cod.235.--/IE76ST chromed/cromata
cod.235.--/IE76STB white/bianco
cod.235.--/IE76STN black/nero
cod.235.--/IK76ST chromed/cromata
cod.235.--/IK76STB white/bianco
cod.235.--/IK76STN black/nero
cod.235.--/IB76ST chromed/cromata
cod.235.--/IB76STB white/bianco
cod.235.--/IB76STN black/nero
cod.235/ITC76ST chromed/cromata
cod.235/ITC76STB white/bianco
cod.235/ITC76STN black/nero

DKK - kr

2.795
2.995
2.995
2.795
2.995
2.995
2.895
3.095
3.095
2.695
2.795
2.795

Fabric required
Fabbisogno di tessuto
1 pcs : Lin Mtrs 1 (h1,40)

COM fabric min. order
10pcs each code
Tessuto cliente TC ordine
min. 10pz per codice

Min. order 4pcs
each code
Ordine min 4pz
per codice

COLORFIVE WRAP ST 66



Upholstered Techno-polymer seat and chromed or painted frame. Sgabello con seduta in tecnopolimero rivestito e telaio in metallo cromato o verniciato.

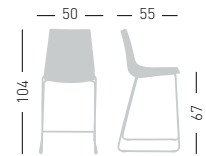

NA not assembled / non assemblato



0,53 m³ - 29,0 kg.
59x53x91cm
66x55x63cm
4 pcs [carton]

Frame Finishing & Codes / Finiture Telai e Codici

cod.235.--/IE66ST chromed/cromata
cod.235.--/IE66STB white/bianco
cod.235.--/IE66STN black/nero
cod.235.--/IK66ST chromed/cromata
cod.235.--/IK66STB white/bianco
cod.235.--/IK66STN black/nero
cod.235.--/IB66ST chromed/cromata
cod.235.--/IB66STB white/bianco
cod.235.--/IB66STN black/nero
cod.235/ITC66ST chromed/cromata
cod.235/ITC66STB white/bianco
cod.235/ITC66STN black/nero

DKK - kr

2.795
2.995
2.995
2.795
2.995
2.995
2.895
3.095
3.095
2.695
2.795
2.795

Fabric required
Fabbisogno di tessuto
1 pcs : Lin Mtrs 1 (h1,40)

COM fabric min. order
10pcs each code
Tessuto cliente TC ordine
min. 10pz per codice

Min. order 4pcs
each code
Ordine min 4pz
per codice



Available coverings / Finiture disponibili
 Aurea eco-leather / Ecopelle aurea **E** (4pcs min.)
 COM fabric / Tessuto cliente **TC** (10pcs min.)

CROSS
 UPHOLSTERED



Leather seat and chromed metal frame.
 Seduta in pelle.
 Telaio in metallo cromato.

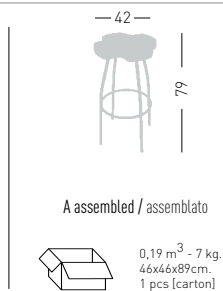

Frame Finishing & Codes / Finiture Telai e Codici

cod.91.--/IEA chromed/cromato
cod.91.--/ITCA chromed/cromato

DKK - kr

1.695
1.595

Fabric required
 Fabbisogno di tessuto
 1 pcs: Lin Mtrs 0,7 (h1,40)

COM fabric min. order
 10pcs each code
 Tessuto cliente TC ordine
 min. 10pz per codice

Min. order 4pcs
 each code
 Ordine min 4pz
 per codice

Dame Stool



Available Shell Color / Colori disponibili Scocca

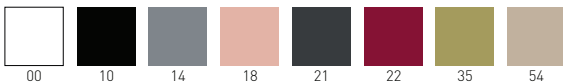

DAME S 68



Chromed wire steel frame, technopolymer shell and upholstered cushion.

Struttura a slitta in filo cromata, scocca in tecnopolimero e cuscino tappezzato.

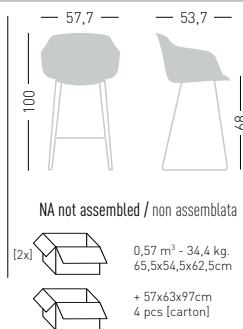

Frame Finishing & Codes / Finiture Telai e Codici

cod. 267. __ - (K) / 68S chromed/cromata
 cod. 267. __ - (B) / 68S chromed/cromata
 cod. 267. __ - (S) / 68S chromed/cromata
 cod. 267. __ - (DK) / 68S chromed/cromata
 cod. 267. __ - (SX) / 68S chromed/cromata
 cod. 267. __ - (E) / 68S chromed/cromata
 cod. 267. __ - (MG) / 68S chromed/cromata
 cod. 267. __ - TC / 68S chromed/cromata

DKK - kr

3.095
3.095
3.095
3.195
3.095
2.995
3.095
2.995

Fabric required
 Fabbisogno di tessuto
 4 pcs: Lin Mtrs 1,0 (h1,40)

COM fabric min. order
 10pcs each code
 Tessuto cliente TC ordine
 min. 10pz per codice

Min. order 4pcs
 each code
 Ordine min 4pz
 per codice

Available Frame Colors / Colori disponibili Telaio



DAME UPHOLSTERED IMBOTTITI

Available coverings / Finiture disponibili
 King fabric / Tessuto King **K** (4pcs min.)
 Blazer fabric / Tessuto Blazer **B** (4pcs min.)
 Superb Trevira Velvet / Velluto Superb Trevira **S** (4pcs min.)
 Kvadrat fabrics / Tessuti Kvadrat **DK** (4pcs min.)
 Aurea eco-leather / Ecopelle Aurea **E** (4pcs min.)
 Leather / Pelle **P** (4pcs min.)
 COM fabric / Tessuto Cliente **TC** (10pcs min.)

DRESS DAME S 68 Chromed wire steel frame, padded and upholstered shell.
 Struttura a slitta in filo cromata, scocca imbottita e rivestita.

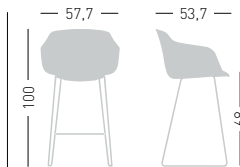

NA not assembled / non assemblata



0,57 m³ - 36,4 kg.
 65,5x54,5x62,5cm



+ 57x63x97cm
 4 pcs [carton]

Frame Finishing & Codes / Finiture Telai e Codici

cod. 267. __/IK68S chromed/cromata
 cod. 267. __/IB68S chromed/cromata
 cod. 267. __/IS68S chromed/cromata
 cod. 267. __/IDK68S chromed/cromata
 cod. 267. __/IE68S chromed/cromata
 cod. 267. __/IP68S chromed/cromata
 cod. 267./ITC68S chromed/cromata

DKK - kr

4.395
4.695
4.695
5.195
4.395
5.195
4.295

Fabric required
 Fabbisogno di tessuto
 1 pc: Lin Mtrs 1,8 (h1,40)

COM fabric min. order
 10pcs each code
 Tessuto cliente TC ordine
 min. 10pz per codice

Min. order 4pcs
 each code
 Ordine min 4pz
 per codice

Available Frame Colors / Colori disponibili Telaio



Chromed
 Cromato



Easy

Available colors / Colori disponibili

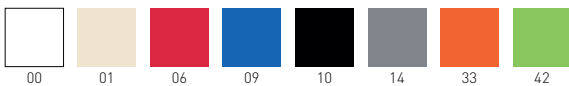

EASY 77



Techno-polymer seat, stackable chromed or painted for outdoor frame.

Seduta in tecnopolimero, telaio impilabile cromato o verniciato per esterno.



only for paintend frames
solo per telai verniciati



stackable / impilabile (5pcs)
NA not assembled / non assemblato



0,240 m³ - 19,8 kg.
91x59x43cm.
4 pcs [carton]

Frame Finishing & Codes / Finiture Telai e Codici

cod. 58.-- / 77 NA chromed/cromata
cod. 58.-- / 77 NAN black painted/verniciato nero
cod. 58.-- / 77 NAB white painted/verniciato bianco

DKK - kr

995
1.195
1.195

EASY 67



Techno-polymer seat, stackable chromed or painted for outdoor frame.

Seduta in tecnopolimero, telaio impilabile cromato o verniciato per esterno.



only for paintend frames
solo per telai verniciati

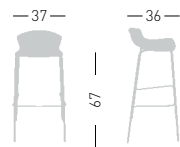

stackable / impilabile (5pcs)
NA not assembled / non assemblato



0,240 m³ - 19 kg.
91x59x43cm.
4 pcs [carton]

Frame Finishing & Codes / Finiture Telai e Codici

cod. 58.-- / 67 NA chromed/cromata
cod. 58.-- / 67 NAN black painted/verniciato nero
cod. 58.-- / 67 NAB white painted/verniciato bianco

DKK - kr

995
1.195
1.195

Fix



Available colors / Colori disponibili



FIX



Techno-polymer seat, chromed frame and combined base. Seduta in tecnopolimero, telaio cromato e base abbinata.

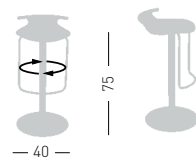

A assembled / assemblato



Frame Finishing & Codes / Finiture Telai e Codici

cod. 32.-- /AF

Base color combined with the seat
Colore base abbinata alla seduta

DKK - kr

1.795

FIX AV



Techno-polymer seat, chromed frame and base. Seduta in tecnopolimero, telaio cromato e base cromata.

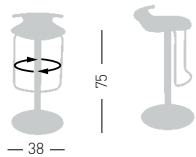

A assembled / assemblato

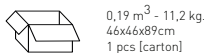

Frame Finishing & Codes / Finiture Telai e Codici

cod.32.--/AFV chromed base/base cromata

DKK - kr

2.095

Format



Available colors / Colori disponibili

Frame / Telaio

Seat / Seduta



FORMAT

Bench with compact seat and outdoor painted metal frame.
Panca con seduta in compacto e telaio in metallo verniciato per esterno.

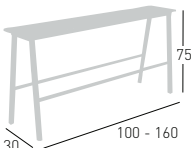
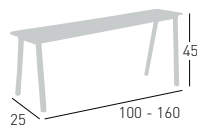

NA not assembled / non assemblato



0,47 m³ - 20kg.
1 pcs [carton]

0,47 m³ - 22kg.
1 pcs [carton]

0,60 m³ - 27kg.
1 pcs [carton]

0,60 m³ - 29kg.
1 pcs [carton]

Frame Finishing & Codes / Finiture Telai e Codici

cod.BFORC848.___/H45 100x30

DKK - kr

4.095

cod.BFORC848.___/H75 100x30

4.195

H75cm Bench with footrail

Panca Altezza 75cm con poggiapiedi

cod.BFORC849.___/H45 160x30

4.795

cod.BFORC849.___/H75 160x30

5.095

H75cm Bench with footrail

Panca Altezza 75cm con poggiapiedi

FORMAT UPHOLSTERED IMBOTTITE

Available coverings / Finiture disponibili
Aurea eco-leather / Ecopelle aurea **E** (4pcs min.)
King fabric / Tessuto King **K** (4pcs min.)
COM fabric / Tessuto cliente **TC** (10pcs min.)

FORMAT UPH

Upholstered bench, painted metal frame.
Panca con seduta tappezzata e telaio in metallo verniciato.

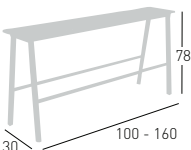
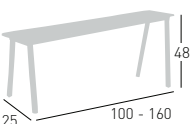

NA not assembled / non assemblato



0,38 m³ - 15kg.
160x80x30cm.
1 pcs [carton]



0,47 m³ - 20kg.
1 pcs [carton]

0,47 m³ - 22kg.
1 pcs [carton]

0,60 m³ - 27kg.
1 pcs [carton]

0,60 m³ - 29kg.
1 pcs [carton]

Frame Finishing & Codes / Finiture Telai e Codici

cod.BFORC848.___/IEH48 100x30

DKK - kr

4.595

cod.BFORC848.___/IKH48 100x30

4.595

cod.BFORC848/ITCH48 100x30

4.395

cod.BFORC848.___/IEH78 100x30

4.795

cod.BFORC848.___/IKH78 100x30

4.795

cod.BFORC848/ITCH78 100x30

4.495

H78cm Bench with footrail

Panca Altezza 78cm con poggiapiedi

cod.BFORC849.___/IEH48 160x30

5.395

cod.BFORC849.___/IKH48 160x30

5.395

cod.BFORC849/ITCH48 160x30

5.095

cod.BFORC849.___/IEH78 160x30

5.595

cod.BFORC849.___/IKH78 160x30

5.595

cod.BFORC849/ITCH78 160x30

5.395

H78cm Bench with footrail

Panca Altezza 78cm con poggiapiedi

Fabric required

Fabbisogno di tessuto

1 pcs: Lin Mtrs 1 (h1,40)

2 pcs: Lin Mtrs 2 (h1,40)

COM fabric min. order

10pcs each code

Tessuto cliente TC ordine

min. 10pz per codice

Min. order 4pcs

each code

Ordine min 4pz

per codice

Free



Available colors / Colori disponibili

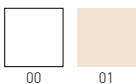

FREE



Techno-polymer seat, chromed frame and combined base. Seduta in tecnopolimero, telaio cromato e base abbinata.

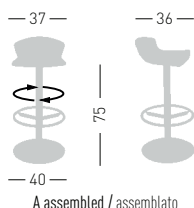

A assembled / assemblato
0,19 m³ - 11 kg.
46x46x89cm
1 pcs [carton]

Frame Finishing & Codes / Finiture Telai e Codici

cod. 57.-- /A

Base color combined with the seat
Colore base abbinata alla seduta

DKK - kr

1.695

FREE AV



Techno-polymer seat, chromed frame and base. Seduta in tecnopolimero, telaio cromato e base cromata.

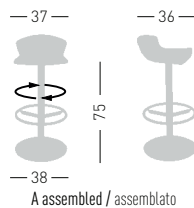

A assembled / assemblato
0,19 m³ - 12 kg.
46x46x89cm
1 pcs [carton]

Frame Finishing & Codes / Finiture Telai e Codici

cod.57.--/AV chromed base/base cromata

DKK - kr

1.895



Freedom

Available colors / Colori disponibili

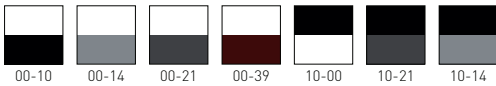

Frame / Telaio
Seat / Seduta

FREEDOM



Techno-polymer seat and frame,
chromed or satin base.
Seduta e telaio in tecnopolimero,
base cromata o satinata.

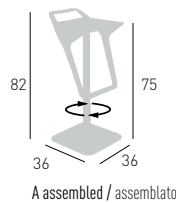

A assembled / assemblato



0,19 m³ - 16 kg.
46x46x89cm.
1 pcs [carton]

Frame Finishing & Codes / Finiture Telaio e Codici

cod.136.--/A chromed base/base cromata
cod.136.--/AS satin base/base satinata

DKK - kr

3.195
3.695

FREEDOM



Techno-polymer seat and frame,
chromed or satin base height
adjustment.
Seduta e telaio in tecnopolimero, base
cromata o satinata, regolabile in altezza.

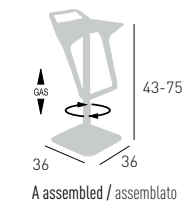

A assembled / assemblato



0,12 m³ - 16,2 kg.
42,5x45x60cm.
1 pcs [carton]

Frame Finishing & Codes / Finiture Telaio e Codici

cod.99.--/A chromed base/base cromata
cod.99.--/AS satin base/base satinata

DKK - kr

2.995
3.495

Fuller



Available colors / Colori disponibili

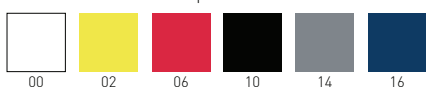

FULLER 75



Stackable techno-polymer stool, outdoor painted frame. Sgabello impilabile con seduta in tecnopolimero e telaio in metallo verniciato per esterno.



Legs and shell colors can be combined. I colori della struttura e della scocca possono essere abbinati.

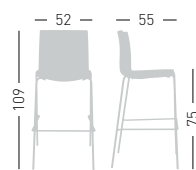

stackable / impilabile (4pcs)
A assembled / assemblato



0,43 m³ - 15 kg.
60x61x118cm.
2 pcs (carton)

Frame Finishing & Codes / Finiture Telai e Codici

cod.379._/75AB
cod.379._/75AN
cod.379._/75AG
cod.379._/75A06
cod.379._/75A02
cod.379._/75A16

DKK - kr

2.095
2.095
2.095
2.095
2.095
2.095

FULLER 65



Stackable techno-polymer stool, outdoor painted frame. Sgabello impilabile con seduta in tecnopolimero e telaio in metallo verniciato per esterno.



Legs and shell colors can be combined. I colori della struttura e della scocca possono essere abbinati.

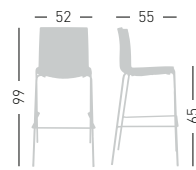

stackable / impilabile (4pcs)
A assembled / assemblato



0,43 m³ - 14,5 kg.
60x61x118cm.
2 pcs (carton)

Frame Finishing & Codes / Finiture Telai e Codici

cod.379._/65AB
cod.379._/65AN
cod.379._/65AG
cod.379._/65A06
cod.379._/65A02
cod.379._/65A16

DKK - kr

2.095
2.095
2.095
2.095
2.095
2.095

Guliver



Available colors / Colori disponibili

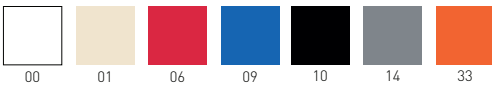

GULIVER



Techno-polymer seat, chromed frame and combined base. Seduta in tecnopolimero, telaio cromato e base abbinata.

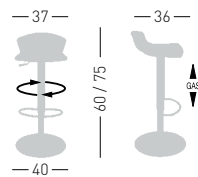

A assembled / assemblato



0,13 m³ - 11 kg.
42x42x77,5cm.
1 pcs [carton]

Frame Finishing & Codes / Finiture Telai e Codici

cod. 56.-- /A

Base color combined with the seat
Colore base abbinata alla seduta

DKK - kr

1.895

GULIVER AV



Techno-polymer seat, chromed frame and base. Seduta in tecnopolimero, telaio cromato e base cromata.

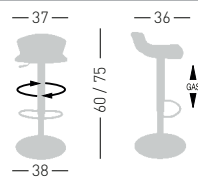

A assembled / assemblato



0,13 m³ - 11,2 kg.
42x42x77,5cm.
1 pcs [carton]

Frame Finishing & Codes / Finiture Telai e Codici

cod. 56.--/AV chromed base/base cromata

DKK - kr

2.095

Isidoro



Available colors / Colori disponibili



ISIDORO 76

Co-injected metal-polymer stackable stool.
Sgabello impilabile in co-iniezione polimero-metallo.



CATAS
TESTATO - TESTED

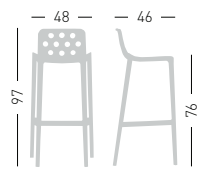

stackable / impilabile (6pcs)
A assembled / assemblato



0,36 m³ - 20,4 kg.
62,5x49x116cm.
4 pcs [carton]

Frame Finishing & Codes / Finiture Telai e Codici

cod.382.--/76A

DKK - kr

1.295

ISIDORO 66

Co-injected metal-polymer stackable stool.
Sgabello impilabile in co-iniezione polimero-metallo.

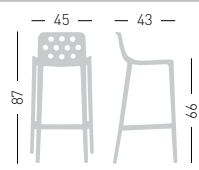

stackable / impilabile (6pcs)
A assembled / assemblato



0,36 m³ - 19,6 kg.
62,5x49x116cm.
4 pcs [carton]

Frame Finishing & Codes / Finiture Telai e Codici

cod.382.--/66A

DKK - kr

1.295

ISIDORO CUSHION / CUSCINO

Upholstered cushion.
Cuscino tappezzato.



Available fabric.
Tessuti disponibili.
E, K (4 psc min)
COM fabric / Tessuto cliente **TC** (10 psc min)



0,4 kg
Inside stools boxes
Nella scatola degli sgabelli

Frame Finishing & Codes / Finiture Telai e Codici

cod.313.--
cod.312.TC COM fabric/tessuto cliente

DKK - kr

550
475

Fabric required
Fabbisogno di tessuto
4 pcs: Lin Mtrs 1,0 (h 1,40)

COM fabric min. order
10pcs each code
Tessuto cliente TC ordine
min. 10pz per codice

Min. order 4pcs
each code
Ordine min 4pz
per codice

ISIDORO UPHOLSTERED IMBOTTITI

Available coverings / Finiture disponibili
Aurea eco-leather / Ecopelle Aurea **E** (4pcs min.)
King fabric / Tessuto King **K** (4pcs min.)
COM fabric / Tessuto cliente **TC** (10pcs min.)

ISIDORO 76 UPHOLSTERED



Upholstered co-injected metal-polymer stool.
Sgabello in co-iniezione polimero-metallo rivestito.

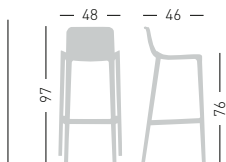

NA seat panel not assembled /
cuscino non assemblato

 0,36 m³ - 23,2 kg.
62,5x49x116cm.
4 pcs [carton]

Frame Finishing & Codes / Finiture Telai e Codici

cod.382.---.---/IE76A

cod.382.---.---/IK76A

cod.382.---.---/ITC76A COM fabric/tessuto cliente

DKK - kr

2.395

2.395

2.195

Fabric required
Fabbisogno di tessuto
2 pcs: Lin Mtrs 1 (h1,40)

COM fabric min. order
10pcs each code
Tessuto cliente TC ordine
min. 10pz per codice

Min. order 4pcs
each code
Ordine min 4pz
per codice

Glossy back coverings colors can be combined with the stool frame.
I colori dei retro-schienali lucidi possono essere abbinati al telaio sgabello.



ISIDORO 66 UPHOLSTERED



Upholstered co-injected metal-polymer stool.
Sgabello in co-iniezione polimero-metallo rivestito.

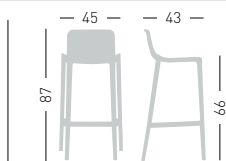

NA seat panel not assembled /
cuscino non assemblato

 0,36 m³ - 22,4 kg.
62,5x49x116cm.
4 pcs [carton]

Frame Finishing & Codes / Finiture Telai e Codici

cod.382.---.---/IE66A

cod.382.---.---/IK66A

cod.382.---.---/ITC+6A COM fabric/tessuto cliente

DKK - kr

2.395

2.395

2.195

Fabric required
Fabbisogno di tessuto
2 pcs: Lin Mtrs 1 (h1,40)

COM fabric min. order
10pcs each code
Tessuto cliente TC ordine
min. 10pz per codice

Min. order 4pcs
each code
Ordine min 4pz
per codice

Glossy back coverings colors can be combined with the stool frame.
I colori dei retro-schienali lucidi possono essere abbinati al telaio sgabello.



Joy



Available colors / Colori disponibili



JOY



Techno-polymer seat, chromed frame and combined base. Seduta in tecnopolimero, telaio cromato e base abbinata.

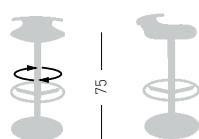

A assembled / assemblato



Frame Finishing & Codes / Finiture Telai e Codici

cod. 43.-- /A

Base color combined with the seat
Colore base abbinata alla seduta

DKK - kr

1.695

JOY AV



Techno-polymer seat, chromed frame and base. Seduta in tecnopolimero, telaio cromato e base cromata.

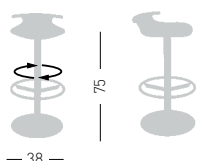

A assembled / assemblato



Frame Finishing & Codes / Finiture Telai e Codici

cod. 43.--/AV chromed base/base cromata

DKK - kr

1.895

Jubel Stool



Available colors / Colori disponibili

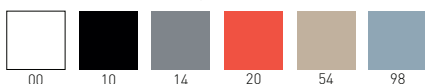

JUBEL ST 76

Techno-polymer seat and chromed or outdoor painted stackable frame. Sgabello con seduta in tecnopolimero e telaio impilabile in metallo cromato o verniciato per esterno.



only for paintend frames
solo per telai verniciati

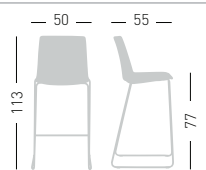

stackable / impilabile (6pcs)
NA not assembled / non assemblato



0,47 m³ - 28,0 kg.
59x53x91 cm.
60x56x51 cm.
4 pcs [carton]

Frame Finishing & Codes / Finiture Telai e Codici

cod. 199. /76ST chromed/cromata
cod. 199. /76STB white painted/verniciato bianco
cod. 199. /76STN black painted/verniciato nero

DKK - kr

1.595
1.795
1.795

JUBEL ST 66

Techno-polymer seat and chromed or outdoor painted stackable frame. Sgabello con seduta in tecnopolimero e telaio impilabile in metallo cromato o verniciato per esterno.



only for paintend frames
solo per telai verniciati

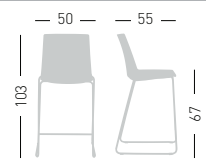

stackable / impilabile (6pcs)
NA not assembled / non assemblato



0,47 m³ - 26,5 kg.
59x53x91 cm.
60x56x51 cm.
4 pcs [carton]

Frame Finishing & Codes / Finiture Telai e Codici

cod. 199. /66ST chromed/cromata
cod. 199. /66STB white painted/verniciato bianco
cod. 199. /66STN black painted/verniciato nero

DKK - kr

1.595
1.795
1.795

JUBEL HS 05R



Swivel on 5-blade painted aluminum base with castors, height adjustable, adjustable footring, technopolymer shell.

Girevole su basamento 5 razze in alluminio verniciato con ruote, regolabile in altezza, poggiatesta regolabile, scocca in tecnopolimero.

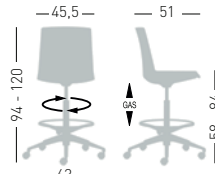

NA not assembled / non assemblato



0,23 m³ - 11,6 kg.
65x54x62cm
1 pcs [carton]

Frame Finishing & Codes / Finiture Telai e Codici

cod. 199. __/HS05RN black painted/verniciata nera
cod. 199. __/HS05R polished/pulita

DKK - kr

2.795
2.895

JUBEL CUSHION / CUSCINO



Upholstered cushion.
Cuscino tappezzato.

Available fabric.
Tessuti disponibili.

B, E, K, DK
COM fabric / Tessuto cliente TC



0,5 kg.
Inside stools boxes
Nella scatola degli sgabelli.

Frame Finishing & Codes / Finiture Telai e Codici

cod. 315. __ (B)
cod. 315. __ (E)
cod. 315. __ (K)
cod. 315. __ (DK)
cod. 315. TC COM fabric/tessuto cliente

DKK - kr

600
550
550
650
475

Fabric required
Fabbisogno di tessuto
4 pcs : Lin Mtrs 1 (h1,40)

COM fabric min. order
10pcs each code
Tessuto cliente TC ordine
min. 10pz per codice

Min. order 4pcs
each code
Ordine min 4pz
per codice

JUBEL UPHOLSTERED IMBOTTITI

Available coverings / Rivestimenti disponibili
Aurea eco-leather / Ecopelle Aurea **E** (4pcs min.)
King fabric / Tessuto King **K** (4pcs min.)
Kvadrat fabrics / Tessuti Kvadrat **DK** (4pcs min.)
COM fabric / Tessuto cliente **TC** (10pcs min.)

JUBEL ST 76 UPHOLSTERED



Upholstered Techno-polymer seat, chromed or painted frame.
Sgabello con seduta in tecnopolimero rivestito e telaio in metallo cromato o verniciato.

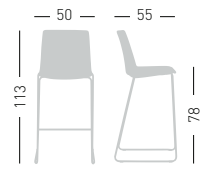

NA not assembled / non assemblato



0,53 m³ - 34 kg.
59x53x91cm
66x55x63cm
4 pcs [carton]

Frame Finishing & Codes / Finiture Telai e Codici

cod. 199. __/IE76ST chromed/cromata
cod. 199. __/IE76STB white/bianco
cod. 199. __/IE76STN black/nero
cod. 199. __/IK76ST chromed/cromata
cod. 199. __/IK76STB white/bianco
cod. 199. __/IK76STN black/nero
cod. 199. __/IDK76ST chromed/cromata
cod. 199. __/IDK76STB white/bianco
cod. 199. __/IDK76STN black/nero
cod. 199/ITC76ST chromed/cromata
cod. 199/ITC76STB white/bianco
cod. 199/ITC76STN black/nero

DKK - kr

2.595
2.795
2.795
2.595
2.795
2.795
3.195
3.395
3.395
2.295
2.595
2.595

Fabric required
Fabbisogno di tessuto
1 pcs: Lin Mtrs 1 (h1,40)

COM fabric min. order
10pcs each code
Tessuto cliente TC ordine
min. 10pz per codice

Min. order 4pcs
each code
Ordine min 4pz
per codice

JUBEL ST 66 UPHOLSTERED



Upholstered Techno-polymer seat, chromed or painted frame.
Sgabello con seduta in tecnopolimero rivestito e telaio in metallo cromato o verniciato.

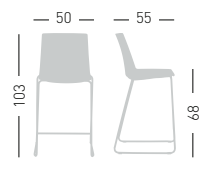

NA not assembled / non assemblato



0,53 m³ - 32,5 kg.
59x53x91cm
66x55x63cm
4 pcs [carton]

Frame Finishing & Codes / Finiture Telai e Codici

cod. 199. __/IE66ST chromed/cromata
cod. 199. __/IE66STB white/bianco
cod. 199. __/IE66STN black/nero
cod. 199. __/IK66ST chromed/cromata
cod. 199. __/IK66STB white/bianco
cod. 199. __/IK66STN black/nero
cod. 199. __/IDK66ST chromed/cromata
cod. 199. __/IDK66STB white/bianco
cod. 199. __/IDK66STN black/nero
cod. 199/ITC66ST chromed/cromata
cod. 199/ITC66STB white/bianco
cod. 199/ITC66STN black/nero

DKK - kr

2.595
2.795
2.795
2.595
2.795
2.795
3.195
3.395
3.395
2.295
2.595
2.595

Fabric required
Fabbisogno di tessuto
1 pcs: Lin Mtrs 1 (h1,40)

COM fabric min. order
10pcs each code
Tessuto cliente TC ordine
min. 10pz per codice

Min. order 4pcs
each code
Ordine min 4pz
per codice

JUBEL BST 76 UPHOLSTERED



Upholstered Techno-polymer seat, chromed or painted frame.
Sgabello con seduta in tecnopolimero rivestito e telaio in metallo cromato o verniciato.

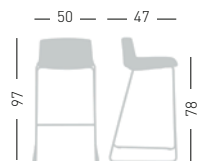

NA not assembled / non assemblato

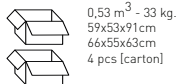

Frame Finishing & Codes / Finiture Telai e Codici

cod. 198. __/IE76ST chromed/cromata
cod. 198. __/IE76STB white/bianco
cod. 198. __/IE76STN black/nero
cod. 198. __/IK76ST chromed/cromata
cod. 198. __/IK76STB white/bianco
cod. 198. __/IK76STN black/nero
cod. 198. __/IDK76ST chromed/cromata
cod. 198. __/IDK76STB white/bianco
cod. 198. __/IDK76STN black/nero
cod. 198./ITC76ST chromed/cromata
cod. 198./ITC76STB white/bianco
cod. 198./ITC76ST black/nero

DKK - kr

2.595
2.795
2.795
2.595
2.795
2.795
3.195
3.395
3.395
2.295
2.595
2.595

Fabric required
Fabbisogno di tessuto
1 pcs: Lin Mtrs 0,8 (h1,40)

COM fabric min. order
10pcs each code
Tessuto cliente TC ordine
min. 10pz per codice

Min. order 4pcs
each code
Ordine min 4pz
per codice

JUBEL BST 66 UPHOLSTERED



Upholstered Techno-polymer seat, chromed or painted frame.
Sgabello con seduta in tecnopolimero rivestito e telaio in metallo cromato o verniciato.

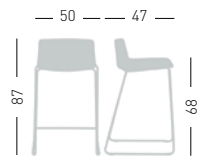

NA not assembled / non assemblato

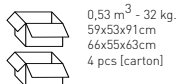

Frame Finishing & Codes / Finiture Telai e Codici

cod. 198. __/IE66ST chromed/cromata
cod. 198. __/IE66STB white/bianco
cod. 198. __/IE66STN black/nero
cod. 198. __/IK66ST chromed/cromata
cod. 198. __/IK66STB white/bianco
cod. 198. __/IK66STN black/nero
cod. 198. __/IDK66ST chromed/cromata
cod. 198. __/IDK66STB white/bianco
cod. 198. __/IDK66STN black/nero
cod. 198./ITC66ST chromed/cromata
cod. 198./ITC66STB white/bianco
cod. 198./ITC66ST black/nero

DKK - kr

2.595
2.795
2.795
2.595
2.795
2.795
3.195
3.395
3.395
2.295
2.595
2.595

Fabric required
Fabbisogno di tessuto
1 pcs: Lin Mtrs 0,8 (h1,40)

COM fabric min. order
10pcs each code
Tessuto cliente TC ordine
min. 10pz per codice

Min. order 4pcs
each code
Ordine min 4pz
per codice

JUBEL HS 05R UPHOLSTERED



Upholstered Techno-polymer seat, swivel on 5-blade painted aluminum base with castors, height adjustable, adjustable footring.
Sgabello con seduta in tecnopolimero rivestito, girevole su basamento 5 razze in alluminio verniciato con ruote, regolabile in altezza, poggiatesta regolabile.

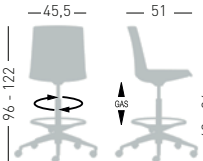

NA not assembled / non assemblato

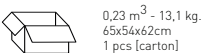

Frame Finishing & Codes / Finiture Telai e Codici

cod. 199. __/IEHS05RN black painted/verniciato nero
cod. 199. __/IEHS05R polished/pulita
cod. 199. __/IKHS05RN black painted/verniciata nera
cod. 199. __/IKHS05R polished/pulita
cod. 199. __/IDKHS05RN black painted/verniciata nera
cod. 199. __/IDKHS05R polished/pulita
cod. 199./ITCHS05RN black painted/verniciata nera
cod. 199./ITCHS05R polished/pulita

DKK - kr

3.795
3.895
3.795
3.895
4.495
4.495
3.595
3.595

Kalipa



Available colors / Colori disponibili

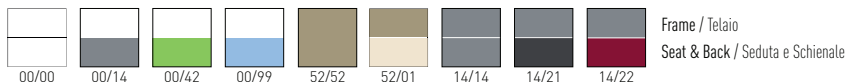

Frame / Telaio
Seat & Back / Seduta e Schienale

KALIPA

Techno-polymer twin material stool.
Sgabello realizzato in tecnopolimero bi-materiale.

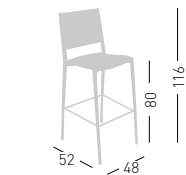

NA not assembled / non assemblato
0,43 m³ - 33 kg.
61x54x20cm
54x54x125cm
4 pcs (carton)

Frame Finishing & Codes / Finiture Telai e Codici

cod.275.-- --/NA

DKK - kr

1.795

KALIPA B

Techno-polymer twin material stool
with integrated armrest.
Sgabello realizzato in tecnopolimero bi-materiale con braccioli.

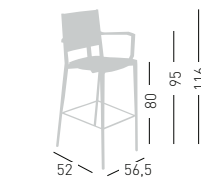

NA not assembled / non assemblato
0,48 m³ - 35,2 kg.
61x54x20cm
54x64x120cm
4 pcs (carton)

Frame Finishing & Codes / Finiture Telai e Codici

cod.276.-- --/NA

DKK - kr

2.095

KALIPA CUSHION / CUSCINO

Upholstered cushion.
Cuscino tappezzato.



Available fabric.
Tessuti disponibili.

E, K
COM fabric / Tessuto cliente TC (10pcs min.)



0,5 kg.
Inside stools boxes
Nella scatola degli sgabelli

Frame Finishing & Codes / Finiture Telai e Codici

cod.306.--
cod.306.TC COM fabric/tessuto cliente

DKK - kr

450

Fabric required
Fabbisogno di tessuto
4 pcs: Lin Mtrs 1,0 (h1,40)

COM fabric min. order
10pcs each code
Tessuto cliente TC ordine
min. 10pz per codice

Min. order 4pcs
each code
Ordine min 4pz
per codice

Kanvas



Available colors / Colori disponibili

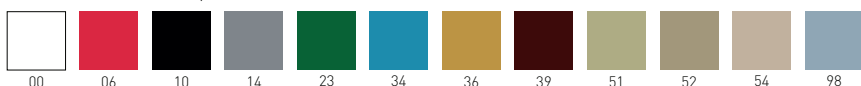

KANVAS ST 76

Techno-polymer seat and chromed or outdoor painted stackable frame. Sgabello impilabile con seduta in tecnopolimero e telaio in metallo cromato o verniciato per esterno.



only for painted frames
solo per telai verniciati

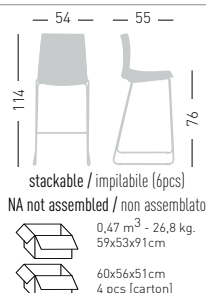

Frame Finishing & Codes / Finiture Telai e Codici

cod.362.--/76ST chromed/cromata
cod.362.--/76STB white painted/verniciato bianco
cod.362.--/76STN black painted/verniciato nero

DKK - kr

1.495
1.795
1.795

KANVAS ST 66

Techno-polymer seat and chromed or outdoor painted stackable frame. Sgabello impilabile con seduta in tecnopolimero e telaio in metallo cromato o verniciato per esterno.



only for painted frames
solo per telai verniciati

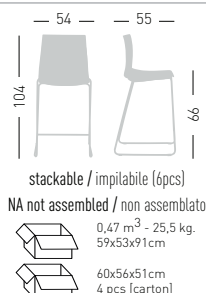

Frame Finishing & Codes / Finiture Telai e Codici

cod.362.--/66ST chromed/cromata
cod.362.--/66STB white painted/verniciato bianco
cod.362.--/66STN black painted/verniciato nero

DKK - kr

1.495
1.795
1.795

KANVAS CUSHION / CUSCINO

Kanvas Upholstered cushion. Cuscino tappezzato Kanvas.



0,5 kg
Inside stools boxes
Nella scatola degli sgabelli

Frame Finishing & Codes / Finiture Telai e Codici

cod.317.--
cod.317.--/DK
cod.317.TC COM fabric/tessuto cliente

DKK - kr

575
725
525

Fabric required
Fabbisogno di tessuto
4 pcs: Lin Mtrs 1,0 (h1,40)

COM fabric min. order
10pcs each code
Tessuto cliente TC ordine
min. 10pz per codice

Min. order 4pcs
each code
Ordine min 4pz
per codice



Available fabric.
Tessuti disponibili.

E, K, DK (4pcs min.)
COM fabric / Tessuto cliente TC (10pcs min.)

KANVAS UPHOLSTERED IMBOTTITI

Available coverings / Finiture disponibili
Aurea eco-leather / Ecopelle aurea **E** (4pcs min.)
King fabric / Tessuto King **K** (4pcs min.)
Blazer fabric / Tessuto Blazer **B** (4pcs min.)
Kvadrat fabrics / Tessuti Kvadrat **DK** (4pcs min.)
COM fabric / Tessuto cliente **TC** (10pcs min.)

KANVAS ST 76 FRONT UPHOLSTERED



Upholstered Techno-polymer seat, chromed or painted frame.
Sgabello con seduta in tecnopolimero rivestito, telaio in metallo cromato o verniciato.

Colours shell / Colori scocca

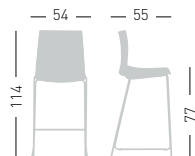

NA not assembled / non assemblato

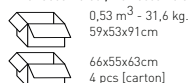

Frame Finishing & Codes / Finiture Telai e Codici

cod.363.--/IE76ST chromed/cromata	DKK - kr	2.395
cod.363.--/IE76STB white/bianco		2.695
cod.363.--/IE76STN black/nero		2.695
cod.363.--/IK76ST chromed/cromata		2.395
cod.363.--/IK76STB white/bianco		2.695
cod.363.--/IK76STN black/nero		2.695
cod.363.--/IB76ST chromed/cromata		2.595
cod.363.--/IB76STB white/bianco		2.795
cod.363.--/IB76STN black/nero		2.795
cod.363.--/IDK76ST chromed/cromata		3.095
cod.363.--/IDK76STB white/bianco		3.395
cod.363.--/IDK76STN black/nero		3.395
cod.363/ITC76ST chromed/cromata		2.095
cod.363/ITC76STB white/bianco		2.395
cod.363/ITC76STN black/nero		2.395

Fabric required
Fabbisogno di tessuto
1 pcs: Lin Mtrs 0,8 (h1,40)

COM fabric min. order
10pcs each code
Tessuto cliente TC ordine
min. 10pz per codice

Min. order 4pcs
each code
Ordine min 4pz
per codice

KANVAS ST 66 FRONT UPHOLSTERED



Upholstered Techno-polymer seat, chromed or painted frame.
Sgabello con seduta in tecnopolimero rivestito, telaio in metallo cromato o verniciato.

Colours shell / Colori scocca

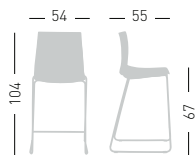

NA not assembled / non assemblato

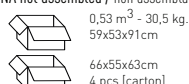

Frame Finishing & Codes / Finiture Telai e Codici

cod.363.--/IE66ST chromed/cromata	DKK - kr	2.395
cod.363.--/IE66STB white/bianco		2.695
cod.363.--/IE66STN black/nero		2.695
cod.363.--/IK66ST chromed/cromata		2.395
cod.363.--/IK66STB white/bianco		2.695
cod.363.--/IK66STN black/nero		2.695
cod.363.--/IB66ST chromed/cromata		2.595
cod.363.--/IB66STB white/bianco		2.795
cod.363.--/IB66STN black/nero		2.795
cod.363.--/IDK66ST chromed/cromata		3.095
cod.363.--/IDK66STB white/bianco		3.395
cod.363.--/IDK66STN black/nero		3.395
cod.363/ITC66ST chromed/cromata		2.095
cod.363/ITC66STB white/bianco		2.395
cod.363/ITC66STN black/nero		2.395

Fabric required
Fabbisogno di tessuto
1 pcs: Lin Mtrs 0,8 (h1,40)

COM fabric min. order
10pcs each code
Tessuto cliente TC ordine
min. 10pz per codice

Min. order 4pcs
each code
Ordine min 4pz
per codice

KANVAS ST 76
FULL UPHOLSTERED



Upholstered Techno-polymer seat, chromed or painted frame.
Sgabello con seduta in tecnopolimero rivestito, telaio in metallo cromato o verniciato.

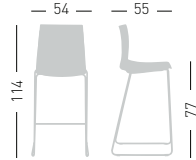

NA not assembled / non assemblato



0,53 m³ - 29,6 kg.
59x53x91cm



66x55x63cm
4 pcs [carton]

Frame Finishing & Codes / Finiture Telai e Codici

cod.362.--/IE76ST chromed/cromata
cod.362.--/IE76STB white/bianco
cod.362.--/IE76STN black/nero
cod.362.--/IK76ST chromed/cromata
cod.362.--/IK76STB white/bianco
cod.362.--/IK76STN black/nero
cod.362.--/IB76ST chromed/cromata
cod.362.--/IB76STB white/bianco
cod.362.--/IB76STN black/nero
cod.362.--/IDK76ST chromed/cromata
cod.362.--/IDK76STB white/bianco
cod.362.--/IDK76STN black/nero
cod.362/ITC76ST chromed/cromata
cod.362/ITC76STB white/bianco
cod.362/ITC76STN black/nero

DKK - kr

3.095
3.395
3.395
3.095
3.395
3.395
3.295
3.595
3.595
3.795
4.095
4.095
2.895
3.095
3.095

Fabric required
Fabbisogno di tessuto
1 pcs : Lin Mtrs 1 (h1,40)

COM fabric min. order
10pcs each code
Tessuto cliente TC ordine
min. 10pz per codice

Min. order 4pcs
each code
Ordine min 4pz
per codice

KANVAS ST 66
FULL UPHOLSTERED



Upholstered Techno-polymer seat, chromed or painted frame.
Sgabello con seduta in tecnopolimero rivestito, telaio in metallo cromato o verniciato.

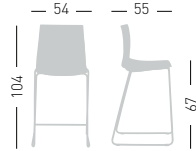

NA not assembled / non assemblato



0,53 m³ - 28,5 kg.
59x53x91cm



66x55x63cm
4 pcs [carton]

Frame Finishing & Codes / Finiture Telai e Codici

cod.362.--/IE66ST chromed/cromata
cod.362.--/IE66STB white/bianco
cod.362.--/IE66STN black/nero
cod.362.--/IK66ST chromed/cromata
cod.362.--/IK66STB white/bianco
cod.362.--/IK66STN black/nero
cod.362.--/IB66ST chromed/cromata
cod.362.--/IB66STB white/bianco
cod.362.--/IB66STN black/nero
cod.362.--/IDK66ST chromed/cromata
cod.362.--/IDK66STB white/bianco
cod.362.--/IDK66STN black/nero
cod.362/ITC66ST chromed/cromata
cod.362/ITC66STB white/bianco
cod.362/ITC66STN black/nero

DKK - kr

3.095
3.395
3.395
3.095
3.395
3.395
3.295
3.595
3.595
3.795
4.095
4.095
2.895
3.095
3.095

Fabric required
Fabbisogno di tessuto
1 pcs : Lin Mtrs 1 (h1,40)

COM fabric min. order
10pcs each code
Tessuto cliente TC ordine
min. 10pz per codice

Min. order 4pcs
each code
Ordine min 4pz
per codice

Kasia Stool



Available shell color / Colori disponibili scocca



Frame finishes / Finiture telaio



KASIA STOOL 76



4-Legged metal stool, painted with special treatment for outdoor purpose, techno-polymer shell. Sgabello con struttura 4 gambe in metallo verniciato con trattamento per esterno, scocca in tecnopolimero.

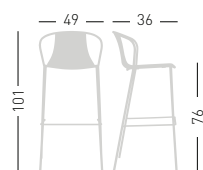

stackable / impilabile (4pcs)
A assembled / assemblato



0,41 m³ - 12,8 kg.
60x59x116cm.
2 pcs [carton]

Frame Finishing & Codes / Finiture Telaio e Codici

cod. 189. ___/76A_

DKK - kr

2.395

KASIA STOOL 66



4-Legged metal stool, painted with special treatment for outdoor purpose, techno-polymer shell. Sgabello con struttura 4 gambe in metallo verniciato con trattamento per esterno, scocca in tecnopolimero.

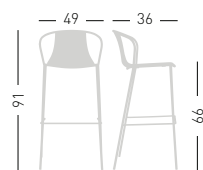

stackable / impilabile (4pcs)
A assembled / assemblato



0,41 m³ - 12,3 kg.
60x59x116cm.
2 pcs [carton]

Frame Finishing & Codes / Finiture Telaio e Codici

cod. 189. ___/66A_

DKK - kr

2.395

KASIA UPHOLSTERED IMBOTTITI



Suitable for outdoor purpose with MG finishes.
Adatto all'uso per esterni con finiture MG.

Available coverings / Finiture disponibili
King fabric / Tessuto King **K** (4pcs min.)
Maglia fabric / Tessuto Maglia **MG** (4pcs min.)
Superb Trevira Velvet / Velluto Superb Trevira **S** (4pcs min.)

KASIA STOOL 76 UPHOLSTERED



4-Legged metal stool, painted with special treatment for outdoor purpose, padded and upholstered shell.
Sgabello con struttura 4 gambe in metallo verniciato con trattamento per esterno, scocca imbottita e rivestita.

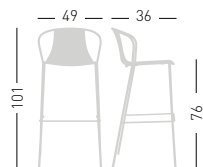

stackable / impilabile (4pcs)
A assembled / assemblato



0,41 m³ - 7,7 kg.
60x59x116cm.
1 pc (carton)

Frame Finishing & Codes / Finiture Telai e Codici

cod. 189. __/IK76A __
cod. 189. __/IMG76A __
cod. 189. __/IS76A __

DKK - kr

4.395
4.395
4.395

Min. order 4pcs
each code
Ordine min 4pz
per codice

KASIA STOOL 66 UPHOLSTERED



4-Legged metal stool, painted with special treatment for outdoor purpose, padded and upholstered shell.
Sgabello con struttura 4 gambe in metallo verniciato con trattamento per esterno, scocca imbottita e rivestita.

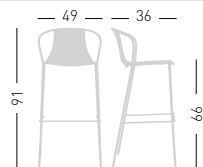

stackable / impilabile (4pcs)
A assembled / assemblato



0,41 m³ - 7,4 kg.
60x59x116cm.
1 pc (carton)

Frame Finishing & Codes / Finiture Telai e Codici

cod. 189. __/IK66A __
cod. 189. __/IMG66A __
cod. 189. __/IS66A __

DKK - kr

4.395
4.395
4.395

Min. order 4pcs
each code
Ordine min 4pz
per codice

Liberty



Available colors / Colori disponibili

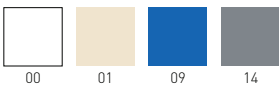

LIBERTY H75

Techno-polymer seat and anodized aluminum frame. Seduta in tecnopolimero, gambe in alluminio anodizzato.

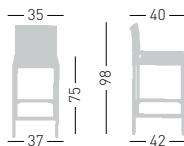

NA not assembled / non assemblato



A assembled / assemblato



Frame Finishing & Codes / Finiture Telai e Codici

cod.26.--/75NA not assembled/non assemblato
cod.26.--/75A assembled/assemblato

DKK - kr

1.295

1.695

LIBERTY H60

Techno-polymer seat and anodized aluminum frame. Seduta in tecnopolimero, gambe in alluminio anodizzato.

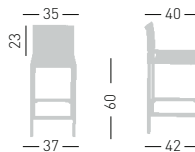

NA not assembled / non assemblato

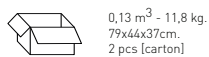

A assembled / assemblato

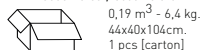

Frame Finishing & Codes / Finiture Telai e Codici

cod.26.--/60NA not assembled/non assemblato
cod.26.--/60A assembled/assemblato

DKK - kr

1.295

1.695

Lilà Stool



Available colors / Colori disponibili

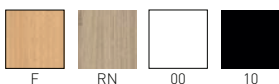

LILÀ STOOL 79

Plywood painted shell and chromed stackable frame.
Scocca in legno curvato, verniciata, telaio impilabile in metallo cromato.

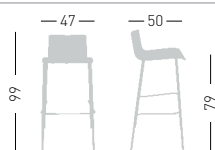

stackable / impilabile (4pcs)

NA not assembled / non assemblato



0,30 m³ - 13 kg.
60x54x92cm.
2 pcs [carton]

Frame Finishing & Codes / Finiture Tetai e Codici

cod.185.--/79NA chromed/cromato

DKK - kr

1.795

LILÀ STOOL 69

Plywood painted shell and chromed stackable frame.
Scocca in legno curvato, verniciata, telaio impilabile in metallo cromato.

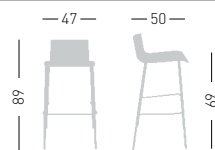

stackable / impilabile (4pcs)

NA not assembled / non assemblato



0,30 m³ - 12,6 kg.
60x54x92cm.
2 pcs [carton]

Frame Finishing & Codes / Finiture Tetai e Codici

cod.185.--/69NA chromed/cromato

DKK - kr

1.795

LILÀ STOOL UPHOLSTERED IMBOTTITI

Available coverings / Finiture disponibili
Regenerated leather / Pelle rigenerata **PR** (4pcs min.)

LILÀ STOOL 79 UPHOLSTERED



Coated shell in regenerated leather,
chromed frame.
Scocca rivestita in pelle rigenerata e
telaio in metallo cromato.

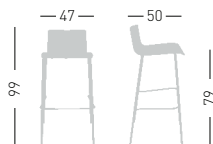

NA not assembled / non assemblato



0,30 m³ - 14 kg.
54x66x91,5cm.
2 pcs [carton]

Frame Finishing & Codes / Finiture Telai e Codici

cod. 185.--/IPR79NA chromed/cromato

DKK - kr

2.895

Min. order 4pcs
each code
Ordine min 4pz
per codice

LILÀ STOOL 69 UPHOLSTERED



Coated shell in regenerated leather,
chromed frame.
Scocca rivestita in pelle rigenerata e
telaio in metallo cromato.

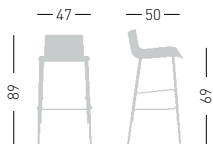

NA not assembled / non assemblato



0,30 m³ - 13,8 kg.
54x66x91,5cm.
2 pcs [carton]

Frame Finishing & Codes / Finiture Telai e Codici

cod. 185.--/IPR69NA chromed/cromato

DKK - kr

2.895

Min. order 4pcs
each code
Ordine min 4pz
per codice



Available colors / Colori disponibili

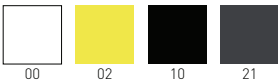

LINK



Metal frame stackable stool painted for outdoor. Sgabello impilabile con struttura in metallo verniciato per esterno.

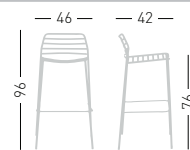

A assembled / assemblato



0,43 m³ - 23 kg.
60x61x118cm.
2 pcs (carton)

Frame Finishing & Codes / Finiture Telai e Codici

cod. 90.-- /A

Paintend with special treatment for outdoor
Verniciato con trattamento per esterno

DKK - kr

2.895

LINK STOOL CUSHION / CUSCINO



Cushion with removable cover, suitable for outdoor purpose; high density bielastic rubber padding, stitching made with raised edge. The cushion is fixed to the stool by Velcro straps.

Cuscino sfoderabile, adatto ad uso per esterni; imbottiture in gomma bielastica ad alta densit, cucitura realizzata con bordino in rilievo riportato. Il cuscino si fissa allo sgabello per mezzo di fascette in Velcro.



0,39 kg.
Inside chairs boxes
Nella scatola delle sedie.

Frame Finishing & Codes / Finiture Telai e Codici

cod.337.-- (MG)

cod.337.-- (SX)

DKK - kr

**675
675**

Min. order 4pcs
each code
Ordine min 4pz
per codice

Available fabric / Tessuti disponibili
Maglia fabric / Tessuto Maglia **MG**
Silvertex Fabric / Tessuto Silvertex **SX**

Manaa Stool



Products follows UNI 9175 -UNI 9175/FA, in terms of Fire Resistance, Fire Reation Class 11M
 Prodotto Omologato dal Ministero dell'Interno, secondo la UNI 9175 -UNI 9175/FA, con classe di Reazione al fuoco 11M



Available coverings / Finiture disponibili
 King fabric / Tessuto King **K** (4pcs min.)
 Blazer fabric / Tessuto Blazer **B** (4pcs min.)
 Superb Trevira Velvet / Velluto Superb Trevira **S** (4pcs min.)
 Leather / Pelle **P** (4pcs min.)
 Aurea eco-leather / Ecopelle Aurea **E** (4pcs min.)
 Kvadrat fabrics / Tessuti Kvadrat **DK** (4pcs min.)
 COM fabric / Tessuto cliente **TC** (10pcs min.)

Frame / Telaio



MANAA 79

Upholstered barstool, techno-polymer base. Sgabellto rivestito, telaio in tecnopolimero.

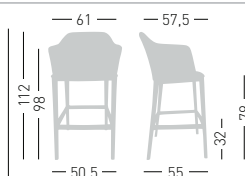

NA not assembled / non assemblato



0,29 m³ - 12,7 kg.
 59,5x53,5x91,5cm.
 1 pcs [carton]

Frame Finishing & Codes / Finiture Telai e Codici

cod.256.--/IK79TP--
 cod.256.--/IB79TP--
 cod.256.--/IS79TP--
 cod.256.--/IP79TP--
 cod.256.--/IE79TP--
 cod.256.--/IDK79TP--
 cod.256.--/IITC79TP--

DKK - kr

5.295
5.895
5.895
6.395
5.995
6.395
5.095

Twin color upholstery details available on request
 Dettagli tappezzeria bi-colore disponibili su richiesta

Fabric required
 Fabbisogno di tessuto
 1 pcs: Lin Mtrs 1 (h1,40)

COM fabric min. order
 10pcs each code
 Tessuto cliente TC ordine
 min. 10pz per codice

Min. order 4pcs
 each code
 Ordine min 4pz
 per codice

MANAA 69

Upholstered barstool, techno-polymer base. Sgabellto rivestito, telaio in tecnopolimero.

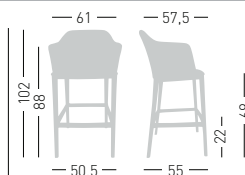

NA not assembled / non assemblato



0,29 m³ - 12,5 kg.
 59,5x53,5x91,5cm.
 1 pcs [carton]

Frame Finishing & Codes / Finiture Telai e Codici

cod.256.--/IK69TP--
 cod.256.--/IB69TP--
 cod.256.--/IS69TP--
 cod.256.--/IP69TP--
 cod.256.--/IE69TP--
 cod.256.--/IDK69TP--
 cod.256.--/IITC69TP--

DKK - kr

5.295
5.895
5.895
6.395
5.295
6.395
5.095

Twin color upholstery details available on request
 Dettagli tappezzeria bi-colore disponibili su richiesta

Fabric required
 Fabbisogno di tessuto
 1 pcs: Lin Mtrs 1 (h1,40)

COM fabric min. order
 10pcs each code
 Tessuto cliente TC ordine
 min. 10pz per codice

Min. order 4pcs
 each code
 Ordine min 4pz
 per codice

Manaa Slim



Products follows UNI 9175 -UNI 9175/FA, in terms of Fire Resistance, Fire Reation Class 11M
 Prodotto Omologato dal Ministero dell'Interno, secondo la UNI 9175 -UNI 9175/FA, con classe di Reazione al fuoco 11M



Available coverings / Finiture disponibili
 King fabric / Tessuto King **K** (4pcs min.)
 Blazer fabric / Tessuto Blazer **B** (4pcs min.)
 Superb Trevira Velvet / Velluto Superb Trevira **S** (4pcs min.)
 Leather / Pelle **P** (4pcs min.)
 Aurea eco-leather / Ecopelle Aurea **E** (4pcs min.)
 Kvadrat fabrics / Tessuti Kvadrat **DK** (4pcs min.)
 COM fabric / Tessuto cliente **TC** (10pcs min.)

Frame / Telaio



MANAA SLIM 79

Upholstered barstool, techno-polymer base. Sgabello rivestito, telaio in tecnopolimero.

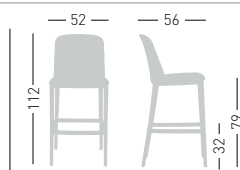

NA not assembled / non assemblato



0,29 m³ - 12,2 kg.
 59,5x53,5x91,5cm.
 1 pcs [carton]

Frame Finishing & Codes / Finiture Telaie e Codici

cod.254.--/IK79TP--
cod.254.--/IE79TP--
cod.254.--/IB79TP--
cod.254.--/IS79TP--
cod.254.--/IP79TP--
cod.254.--/DK79TP--
cod.254/ITC79TP--

DKK - kr

4.995
4.995
5.495
5.495
5.995
5.995
4.795

Twin color upholstery details available on request
 Dettagli tappezzeria bi-colore disponibili su richiesta

Fabric required
 Fabbisogno di tessuto
 1 pcs: Lin Mtrs 1 (h1,40)

COM fabric min. order
 10pcs each code
 Tessuto cliente TC ordine
 min. 10pz per codice

Min. order 4pcs
 each code
 Ordine min 4pz
 per codice

MANAA SLIM 69

Upholstered barstool, techno-polymer base. Sgabello rivestito, telaio in tecnopolimero.

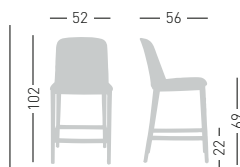

NA not assembled / non assemblato



0,29 m³ - 12 kg.
 59,5x53,5x91,5cm.
 1 pcs [carton]

Frame Finishing & Codes / Finiture Telaie e Codici

cod.254.--/IK69TP--
cod.254.--/IE69TP--
cod.254.--/IB69TP--
cod.254.--/IS69TP--
cod.254.--/IP69TP--
cod.254.--/DK69TP--
cod.254/ITC69TP--

DKK - kr

4.995
4.995
5.495
5.495
5.995
5.995
4.795

Twin color upholstery details available on request
 Dettagli tappezzeria bi-colore disponibili su richiesta

Fabric required
 Fabbisogno di tessuto
 1 pcs: Lin Mtrs 1 (h1,40)

COM fabric min. order
 10pcs each code
 Tessuto cliente TC ordine
 min. 10pz per codice

Min. order 4pcs
 each code
 Ordine min 4pz
 per codice

Max



Available colors / Colori disponibili

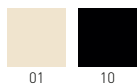

MAX H42

Techno-polymer seat and anodized aluminum frame.
Seduta in tecnopolimero, gambe in alluminio anodizzato.

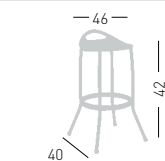

NA not assembled / non assemblato



0,06 m³ - 7,6 kg.
16x78x41,5cm.
2 pcs [carton]

Frame Finishing & Codes / Finiture Telai e Codici

cod.16.--/42NA

DKK - kr

795

MAX H60

Techno-polymer seat and anodized aluminum frame.
Seduta in tecnopolimero, gambe in alluminio anodizzato.

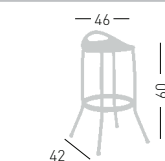

NA not assembled / non assemblato



0,06 m³ - 7,8 kg.
16x78x41,5cm.
2 pcs [carton]

Frame Finishing & Codes / Finiture Telai e Codici

cod.16.--/60NA

DKK - kr

795

MAX H75

Techno-polymer seat and anodized aluminum frame.
Seduta in tecnopolimero, gambe in alluminio anodizzato.

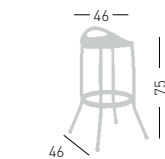

NA not assembled / non assemblato



0,06 m³ - 9 kg.
16x78x41,5cm.
2 pcs [carton]

Frame Finishing & Codes / Finiture Telai e Codici

cod.16.--/75NA

DKK - kr

795



Micro

Available colors / Colori disponibili

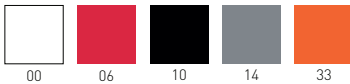

MICRO A



Techno-polymer seat, chromed frame and combined base. Seduta in tecnopolimero, telaio cromato e base abbinata.

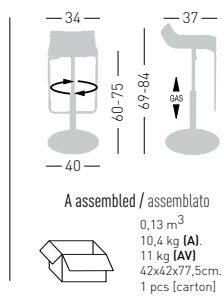

Frame Finishing & Codes / Finiture Telai e Codici

cod. 59.-- /A
 Base color combined with the seat
 Colore base abbinata alla seduta

DKK - kr **1.995**

cod. 59.-- /AV
 chromed base/base cromata

DKK - kr **2.295**

MICRO X



Techno-polymer seat, chromed frame and base. Seduta in tecnopolimero, telaio e base cromati.

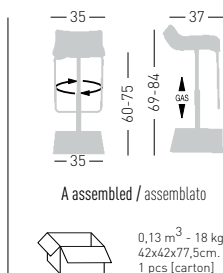

Frame Finishing & Codes / Finiture Telai e Codici

cod. 59.-- /X chromed base/base cromata

DKK - kr **2.695**

Moema



Available colors / Colori disponibili



00

MOEMA



Techno-polymer seat, chromed frame and base. Seduta in tecnopolimero, telaio cromato e base cromata.

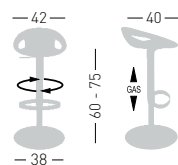

A assembled / assemblato



0,19 m³ - 9,5 kg.
46x46x89cm
1 pcs [carton]

Frame Finishing & Codes / Finiture Telai e Codici

cod. 74.-- /A
chromed base/base cromata

DKK - kr

2.395

MOEMA UPHOLSTERED IMBOTTITI

Available coverings / Finiture disponibili
Leather / Pelle **P** (4pcs min.)

MOEMA UPHOLSTERED



Techno-polymer seat upholstered in leather, anodized aluminum frame. Seduta in tecnopolimero rivestito in pelle, telaio cromato e base cromata.

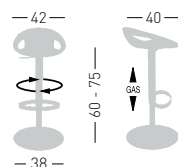

A assembled / assemblato



0,19 m³ - 10 kg.
46x46x89cm
1 pcs [carton]

Frame Finishing & Codes / Finiture Telai e Codici

cod.74.--/IPA

DKK - kr

4.495

Min. order 4pcs
each code
Ordine min 4pz
per codice

MOEMA STOOL 75



Chromed or painted 4-Legged metal frame; techno-polymer shell.
Struttura in metallo 4 gambe, cromata o verniciata; scocca in tecnopolimero.



only for painted frames
solo per telai verniciati

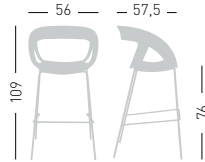

NA not assembled / non assemblata



0,57 m³ - 32,4 kg.
65,5x54,5x62,5cm



+ 57x63x97cm
4 pcs [carton]

Frame Finishing & Codes / Finiture Telai e Codici

cod. **70__/75NA** chromed/cromata
cod. **70__/75NAN** black painted/verniciato nero
cod. **70__/75NAB** white painted/verniciato bianco

DKK - kr

1.695
1.895
1.895

Available Shell Colors / Colori disponibili Scocca

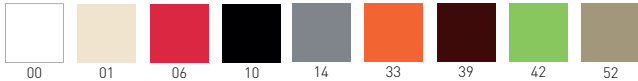

MOEMA CUSHION / CUSCINO



Upholstered cushion.
Cuscino tappezzato.

Available fabric.
Tessuti disponibili.
B, E, K
COM fabric / Tessuto cliente **TC**



0,6 kg
Inside chairs boxes
Inseriti nella
scatola delle sedie

Frame Finishing & Codes / Finiture Telai e Codici

cod. **310.--**
cod. **310.-- (B)**
cod. **310.TC** COM fabric/tessuto cliente

DKK - kr

550
650
500

Fabric required
Fabbisogno di tessuto
4 pcs: Lin Mtrs 1,0 (h1,40)

COM fabric min. order
10pcs each code
Tessuto cliente TC ordine
min. 10pz per codice

Min. order 4pcs
each code
Ordine min 4pz
per codice

MOEMA UPHOLSTERED IMBOTTITI

Available coverings / Finiture disponibili
Leather / Pelle **P** (4pcs min.)
King fabric / Tessuto King **K** (4pcs min.)
Aurea eco-leather / Ecopelle aurea **E** (4pcs min.)
COM fabric / Tessuto cliente **TC** (10pcs min.)

MOEMA STOOL 78 UPHOLSTERED



Chromed or Painted 4-legged metal frame, padded and upholstered shell.
Sgabello con seduta imbottita e rivestita, telaio 4 gambe in metallo cromato o verniciato.

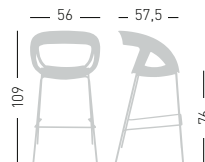

NA not assembled / non assemblata



0,57 m³ - 36 kg.
65,5x54,5x62,5cm



+ 57x63x97cm
4 pcs [carton]

Frame Finishing & Codes / Finiture Telai e Codici

cod. **70__/IP78NA** chromed/cromata
cod. **70__/IP78NAN** black painted/verniciato nero
cod. **70__/IP78NAB** white painted/verniciato bianco
cod. **70__/IK78NA** chromed/cromata
cod. **70__/IK78NAN** black painted/verniciato nero
cod. **70__/IK78NAB** white painted/verniciato bianco
cod. **70__/IE78NA** chromed/cromata
cod. **70__/IE78NAN** black painted/verniciato nero
cod. **70__/IE78NAB** white painted/verniciato bianco
cod. **70__/ITC78NA** chromed/cromata
cod. **70__/ITC78NAN** black painted/verniciato nero
cod. **70__/ITC78NAB** white painted/verniciato bianco

DKK - kr

3.695
3.795
3.795
3.495
3.595
3.595
3.495
3.595
3.595
3.395
3.495
3.495

Fabric required
Fabbisogno di tessuto
1 pcs: Lin Mtrs 1,5 (h1,40)

COM fabric min. order
10pcs each code
Tessuto cliente TC ordine
min. 10pz per codice

Min. order 4pcs
each code
Ordine min 4pz
per codice

More



Available colors / Colori disponibili

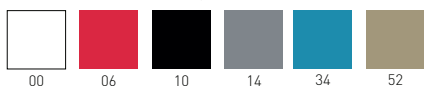

MORE ST 76



Techno-polymer seat, chromed or outdoor painted frame.
Sgabello con seduta in tecnopolimero e telaio in metallo cromato o verniciato per esterno.



only for paintend frames
solo per telai verniciati

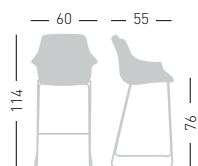

NA not assembled / non assemblato

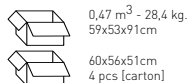

Frame Finishing & Codes / Finiture Telai e Codici

cod.171.--/76ST chromed/cromata
cod.171.--/76STB white/bianco
cod.171.--/76STN black/nero

DKK - kr

1.495
1.795
1.795

MORE ST 66



Techno-polymer seat, chromed or outdoor painted frame.
Sgabello con seduta in tecnopolimero e telaio in metallo cromato o verniciato per esterno.



only for paintend frames
solo per telai verniciati

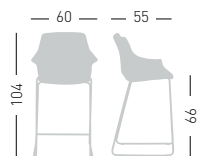

NA not assembled / non assemblato

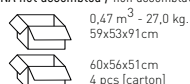

Frame Finishing & Codes / Finiture Telai e Codici

cod.171.--/66ST chromed/cromata
cod.171.--/66STB white/bianco
cod.171.--/66STN black/nero

DKK - kr

1.495
1.795
1.795

MORE UPHOLSTERED IMBOTTITI

Products follows UNI 9175 -UNI 9175/FA, in terms of Fire Resistance, Fire Reation Class 1IM
Prodotto Omologato dal Ministero dell'Interno, secondo la UNI 9175 -UNI 9175/FA, con classe di Reazione al fuoco 1IM



Available coverings / Finiture disponibili
Aurea eco-leather / Ecopelle Aurea **E** (4pcs min.)
King fabric / Tessuto King **K** (4pcs min.)
Kvadrat fabrics / Tessuti Kvadrat **DK** (4pcs min.)
COM fabric / Tessuto cliente **TC** (10pcs min.)

MORE ST 76 UPHOLSTERED



Upholstered techno-polymer seat and chromed or outdoor painted frame.
Sgabello con seduta in tecnopolimero e telaio in metallo cromato o verniciato per esterno.

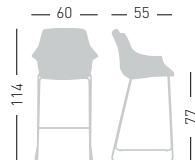

NA not assembled / non assemblato

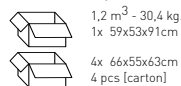

1,2 m³ - 30,4 kg.
1x 59x53x91cm

4x 66x55x63cm
4 pcs [carton]

Frame Finishing & Codes / Finiture Telai e Codici

cod.171.--/IE76ST chromed/cromata
cod.171.--/IE76STB white/bianco
cod.171.--/IE76STN black/nero

cod.171.--/IK76ST chromed/cromata
cod.171.--/IK76STB white/bianco
cod.171.--/IK76STN black/nero

cod.171.--/IDK76ST chromed/cromata
cod.171.--/IDK76STB white/bianco
cod.171.--/IDK76STN black/nero

cod.171/ITC76ST chromed/cromata
cod.171/ITC76STB white/bianco
cod.171/ITC76STN black/nero

DKK - kr

5.095

5.295

5.295

5.095

5.295

5.295

5.895

6.095

6.095

4.795

4.995

4.995

Fabric required
Fabbisogno di tessuto
1 pcs: Lin Mtrs 1,3 (h1,40)

COM fabric min. order
10pcs each code
Tessuto cliente TC ordine
min. 10pz per codice

Min. order 4pcs
each code
Ordine min 4pz
per codice

MORE ST 66 UPHOLSTERED



Upholstered techno-polymer seat and chromed or outdoor painted frame.
Sgabello con seduta in tecnopolimero e telaio in metallo cromato o verniciato per esterno.

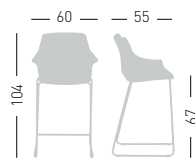

NA not assembled / non assemblato

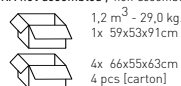

1,2 m³ - 29,0 kg.
1x 59x53x91cm

4x 66x55x63cm
4 pcs [carton]

Fabric required
Fabbisogno di tessuto
1 pcs: Lin Mtrs 1,3 (h1,40)

Frame Finishing & Codes / Finiture Telai e Codici

cod.171.--/IE66ST chromed/cromata
cod.171.--/IE66STB white/bianco
cod.171.--/IE66STN black/nero

cod.171.--/IK66ST chromed/cromata
cod.171.--/IK66STB white/bianco
cod.171.--/IK66STN black/nero

cod.171.--/IDK66ST chromed/cromata
cod.171.--/IDK66STB white/bianco
cod.171.--/IDK66STN black/nero

cod.171/ITC66ST chromed/cromata
cod.171/ITC66STB white/bianco
cod.171/ITC66STN black/nero

DKK - kr

5.095

5.295

5.295

5.095

5.295

5.295

5.895

6.095

6.095

4.795

4.995

4.995

Fabric required
Fabbisogno di tessuto
1 pcs: Lin Mtrs 1,3 (h1,40)

COM fabric min. order
10pcs each code
Tessuto cliente TC ordine
min. 10pz per codice

Min. order 4pcs
each code
Ordine min 4pz
per codice

Nuta Stool



Available Color / Colori disponibili

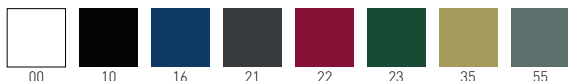

NUTA STOOL 78

Stackable techno-polymer stool.
Sgabello impilabile in tecnopolimero.



CATAS
TESTATO - TESTED

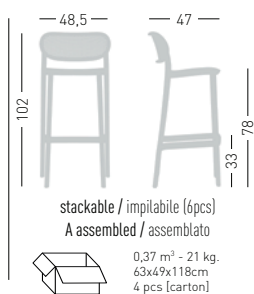

Frame Finishing & Codes / Finiture Telai e Codici

cod. 356.____/78A

DKK - kr

1.195

NUTA STOOL 68

Stackable techno-polymer stool.
Sgabello impilabile in tecnopolimero.

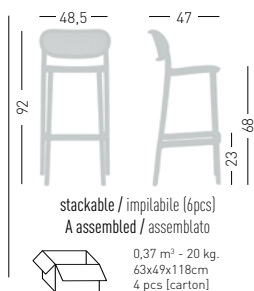

Frame Finishing & Codes / Finiture Telai e Codici

cod. 356.____/68A

DKK - kr

1.195

NUSTA STOOL
CUSHION / CUSCINO

Stool upholstered cushion.
Cuscino tappezzato.

Available fabric.
Tessuti disponibili.
K, B, E, DK, TC



2 kg.
Inside chairs
boxes
Nella scatola
delle sedie.
4 pcs [carton]

Frame Finishing & Codes / Finiture Telai e Codici

cod.335.-- (K)
cod.335.-- (E)
cod.335.-- (B)
cod.335.-- (DK)
cod.335.TC COM fabric/tessuto cliente

DKK - kr

525
525
550
625
450



Minimum order 4pcs each code
Ordine minimo 4 pezzi per codice

COM fabric minimum order 10pcs each code
Tessuto cliente TC ordine minimo 10pz per codice

Fabric required / Fabbisogno di tessuto
1 pcs : Lin Mtrs 0,5 (h1,40)



Nuta Light Stool

Available frame colors / Colori disponibili telaio

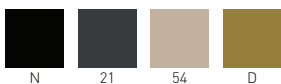

Available coverings / Finiture disponibili
King fabric / Tessuto King **K** (4pcs min.)
Maglia fabric / Tessuto Maglia **MG** (4pcs min.)
Superb Trevira Velvet / Velluto Superb Trevira **S** (4pcs min.)

NUSTA LIGHT
STOOL 77

Metal frame, padded and upholstered
seat and back. Stackable stool.
Struttura in metallo a sostegno di
sedile e schienale, imbottiti e rivestiti.
Sgabello impilabile.

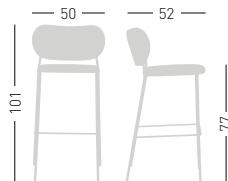

stackable / impilabile (2pcs)
A assembled / assemblato



0,41 m³ - 7,7 kg.
60x59x116cm
1 pc [carton]

Frame Finishing & Codes / Finiture Telai e Codici

cod. 359.--/IK77A_
cod. 359.--/IMG77A_
cod. 359.--/IS77A_

DKK - kr

4.495
4.495
4.495

Min. order 4pcs
each code
Ordine min 4pz
per codice

NUTA LIGHT STOOL 67



Metal frame, padded and upholstered seat and back. Stackable stool. Struttura in metallo a sostegno di sedile e schienale, imbottiti e rivestiti. Sgabello impilabile.

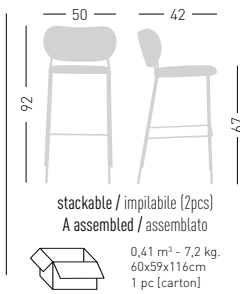

Frame Finishing & Codes / Finiture Telai e Codici

cod. 359.--/IK67A_
cod. 359.--/IMG67A_
cod. 359.--/IS67A_

DKK - kr

4.495
4.495
4.495

Min. order 4pcs
each code
Ordine min 4pz
per codice



Available colors / Colori disponibili

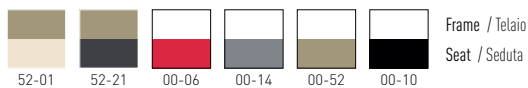

OCTO



Seat and frame in techno-polymer, swivel chromed or satin base. Seduta e telaio in tecnopolimero, basamento girevole cromato o satinato.

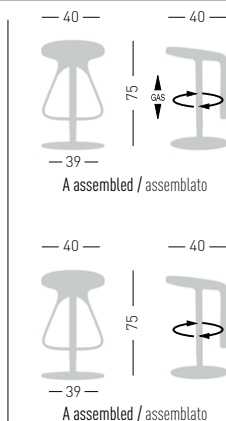

0,12 m³ - 16 kg.
43,5x45x60cm
1 pcs [carton]

Frame Finishing & Codes / Finiture Telai e Codici
chromed frame/telaio cromato

cod. 146.--/A
swivel and adjustable stool
girevole + alzata gas

DKK - kr

3.195

satin frame/telaio satinato

cod. 146.--/AS
swivel and adjustable stool
girevole + alzata gas

3.695



0,19 m³ - 15,5 kg.
46x46x89cm
1 pcs [carton]

chromed frame/telaio cromato

cod. 147.--/A
swivel stool
solo girevole

3.395

satin frame/telaio satinato

cod. 147.--/AS
swivel stool
solo girevole

3.895

Ofer



Available colors / Colori disponibili



OFER H60



Techno-polymer seat and anodized aluminum frame. Seduta in tecnopolimero, gambe in alluminio anodizzato.

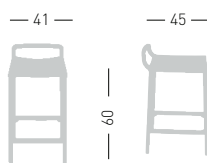

NA not assembled / non assemblato



0,06 m³ - 10,2 kg.
16x78x41,5cm.
2 pcs [carton]

Frame Finishing & Codes / Finiture Telai e Codici

cod.37.--/60NA

DKK - kr

1.095

OFER H75



Techno-polymer seat and anodized aluminum frame. Seduta in tecnopolimero, gambe in alluminio anodizzato.

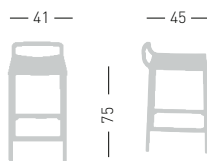

NA not assembled / non assemblato



0,06 m³ - 11 kg.
16x78x41,5cm.
2 pcs [carton]

Frame Finishing & Codes / Finiture Telai e Codici

cod.37.--/75NA

DKK - kr

1.095

Over



Available colors / Colori disponibili



OVER



Techno-polymer seat, chromed frame and combined base. Seduta in tecnopolimero, telaio cromato e base abbinata.

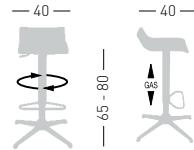

A assembled / assemblato



Frame Finishing & Codes / Finiture Telai e Codici

cod. 39.-- /A

Base color combined with the seat
Colore base abbinata alla seduta

DKK - kr

1.895

OVER T



Techno-polymer seat, chromed frame and combined base. Seduta in tecnopolimero, telaio cromato e base abbinata.

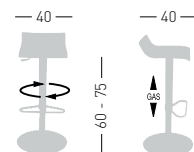

A assembled / assemblato



Frame Finishing & Codes / Finiture Telai e Codici

cod. 39.-- /T

Base color combined with the seat
Colore base abbinata alla seduta

DKK - kr

2.095

OVER TV



Techno-polymer seat, chromed frame and base. Seduta in tecnopolimero, telaio cromato e base cromata.

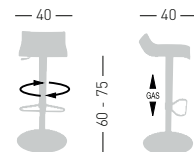

A assembled / assemblato



Frame Finishing & Codes / Finiture Telai e Codici

cod. 39.-- /TV chromed base/base cromata

DKK - kr

2.295

Panama



Available colors / Colori disponibili



PANAMA



Techno-polymer shell and painted metal frame.
Scocca in tecnopolimero e struttura in metallo verniciato.



A assembled / assemblato



0,43 m³ - 6,5 kg.
60x61x118cm.
1 pcs [carton]

Frame Finishing & Codes / Finiture Telai e Codici

cod. 242.-- /A

DKK - kr

3.095

PANAMA B



Techno-polymer shell with armrests and painted metal frame.
Scocca in tecnopolimero con braccioli e struttura in metallo verniciato.

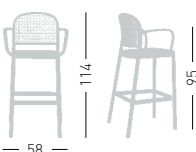

A assembled / assemblato



0,43 m³ - 7 kg.
60x61x118cm.
1 pcs [carton]

Frame Finishing & Codes / Finiture Telai e Codici

cod. 243.-- /A

DKK - kr

3.495

PANAMA BL



Techno-polymer shell and beech wooden frame.
Scocca in tecnopolimero e struttura in legno di faggio.



Price + DKK 150

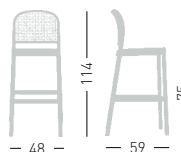

A assembled / assemblato



0,43 m³ - 6,6 kg.
60x61x118cm.
1 pcs [carton]

Frame Finishing & Codes / Finiture Telai e Codici

cod. 242.--/BL_

DKK - kr

3.195

Felt Glides / Tappi in feltro

PANAMA BLB



Techno-polymer shell with armrests and beech wooden frame.
Scocca in tecnopolimero con braccioli e struttura in legno di faggio.

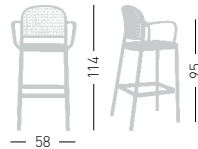

A assembled / assemblato



0,43 m³ - 7,2 kg.
60x61x118cm.
1 pcs [carton]

Frame Finishing & Codes / Finiture Telai e Codici

cod.243.--/BL_

DKK - kr

3.595

Felt Glides / Tappi in feltro



Price + DKK 150)

F

RN

PANAMA CUSHION CUSCINO



Upholstered cushion.
Cuscino tappezzato.

Available fabric.
Tessuti disponibili.

E, K
COM fabric / Tessuto cliente TC (10pcs min.)



0,060 m³ - 0,57 kg.
4 pcs [carton]

Frame Finishing & Codes / Finiture Telai e Codici

cod.303.---- seat/sedile

DKK - kr

675

It is possible to order the seat cushion only if coupled to the chair
Cuscino sedile ordinabile solo se accoppiato alla sedia

Fabric required
Fabbisogno di tessuto
4 pcs: Lin Mtrs 1,0 (h1,40)

COM fabric min. order
10pcs each code
Tessuto cliente TC ordine
min. 10pz per codice

Min. order 4pcs
each code
Ordine min 4pz
per codice



Prodige

Available colors / Colori disponibili

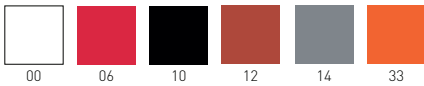

PRODIGE 77



Techno-polymer shell, chromed or outdoor painted frame.
Seduta in tecnopolimero, telaio cromato o verniciato per esterno.



only for painted frames
solo per telai verniciati

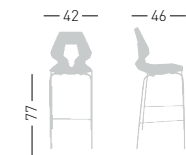

NA not assembled / non assemblato



0,31 m³ - 13,5 kg.
54x60x91,5cm
2 pcs [carton]

Frame Finishing & Codes / Finiture Telai e Codici

cod. 63.-- /77 NA chromed/cromata
cod. 63.-- /77 NAB white painted/verniciato bianco
cod. 63.-- /77 NAN black painted/verniciato nero

DKK - kr

1.495
1.595
1.595

PRODIGE 67



Techno-polymer shell, chromed or outdoor painted frame.
Seduta in tecnopolimero, telaio cromato o verniciato per esterno.



only for painted frames
solo per telai verniciati

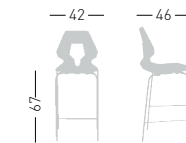

NA not assembled / non assemblato



0,31 m³ - 12,6 kg.
54x60x91,5cm
2 pcs [carton]

Frame Finishing & Codes / Finiture Telai e Codici

cod. 63.-- /67 NA chromed/cromata
cod. 63.-- /67 NAB white painted/verniciato bianco
cod. 63.-- /67 NAN black painted/verniciato nero

DKK - kr

1.495
1.595
1.595

Ritmo



RITMO



Swivel and height adjustable pivoting stool "Ritmo".
Black structure with chromed gas lift.
Sgabello girevole, orientabile e regolabile in altezza "Ritmo".
Struttura nera con alzata gas cromata

Available fabric.
Tessuti disponibili.
K, E, B, DK, TC

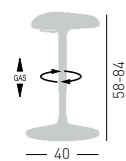

A assembled / assemblato



0,13 m³ - 7 kg.
42x42x77cm.
1 pcs [carton]

Frame Finishing & Codes / Finiture Telai e Codici

cod. 73._/IKA
cod. 73._/IEA
cod. 73._/IBA
cod. 73._/IDKA
cod. 73/ITCA COM fabric/tessuto cliente

Fabric required
Fabbisogno di tessuto
2 pcs: Lin Mtrs 0,8 (h1,40)

COM fabric min. order
10pcs each code
Tessuto cliente TC ordine
min. 10pz per codice

DKK - kr

3.395
3.395
3.495
3.595
3.195

Min. order 4pcs
each code
Ordine min 4pz
per codice



Roller

Available colors / Colori disponibili

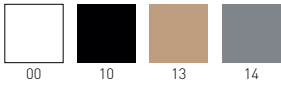

ROLLER

Techno-polymer stool.
Sgabello in tecnopolimero.



CATAS
TESTATO - TESTED



A assembled / assemblato



0,11 m³ - 3,5 kg.
43,5x45x0cm
1 pcs [carton]

Frame Finishing & Codes / Finiture Telai e Codici

cod. 244.-- / A

DKK - kr

1.395

ROLLER 75

Techno-polymer stool.
Sgabello in tecnopolimero.



CATAS
TESTATO - TESTED



A assembled / assemblato



0,19 m³ - 6 kg.
46x46x89cm
1 pcs [carton]

Frame Finishing & Codes / Finiture Telai e Codici

cod.245.--/A

DKK - kr

1.895

Sanela Stool



Available rope color / Colori disponibili corda



Available colors / Colori disponibili



SANELA STOOL 75

4-Legged metal stool, painted with special treatment for outdoor purpose, with wrapped rope.
Sgabello con struttura 4 gambe in metallo verniciato con trattamento per esterno, con intreccio artigianale di corda.

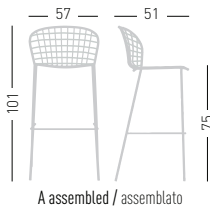

0,41 m³ - 7,5 kg.
60x59x116cm.
1 pc [carton]

Frame Finishing & Codes / Finiture Telai e Codici

cod. 274_(1)/75A_

DKK - kr

5.495

Min. order 20pcs
each code
Ordine min 20pz
per codice



Available colors / Colori disponibili

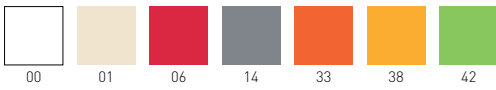

SHIVER



Stackable techno-polymer stool.
Sgabello impilabile in tecnopolimero.

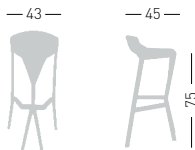

stackable / impilabile (4pcs)
A assembled / assemblato



0,35 m³ - 19 kg.
62,5x46x97cm.
4 pcs [carton]

Frame Finishing & Codes / Finiture Telai e Codici

cod.68.--/A

DKK - kr

1.095

Slot Fill

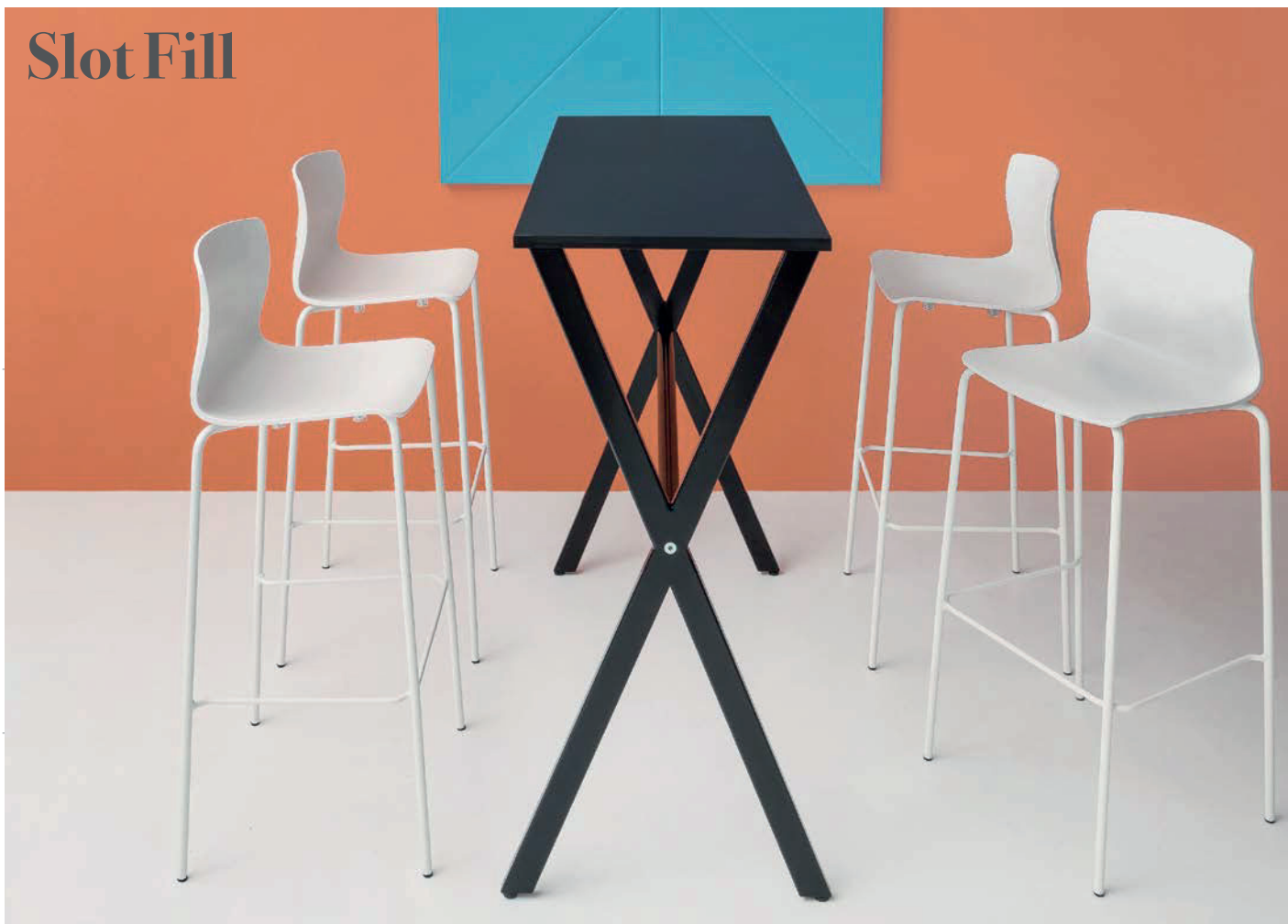

Available colors / Colori disponibili

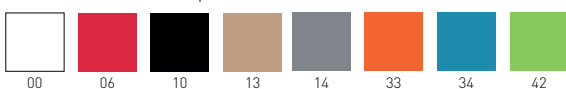

SLOT FILL 78



Stackable techno-polymer stool, chromed or outdoor painted frame. Sgabello impilabile con seduta in tecnopolimero e telaio in metallo cromato o verniciato per esterno.



only for painted frames
solo per telai verniciati

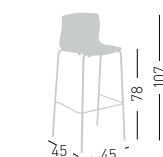

stackable / impilabile (4pcs)
NA not assembled / non assemblato

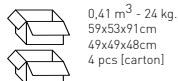

0,41 m³ - 24 kg.
59x53x91cm
49x49x48cm
4 pcs [carton]

Frame Finishing & Codes / Finiture Telai e Codici

cod.259.--/78NA chromed/cromata
cod.259.--/78NAB white/bianco

DKK - kr

1.395
1.595

SLOT FILL 68



Stackable techno-polymer stool, chromed or outdoor painted frame. Sgabello impilabile con seduta in tecnopolimero e telaio in metallo cromato o verniciato per esterno.



only for painted frames
solo per telai verniciati

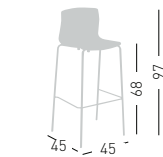

stackable / impilabile (4pcs)
NA not assembled / non assemblato

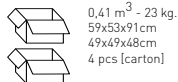

0,41 m³ - 23 kg.
59x53x91cm
49x49x48cm
4 pcs [carton]

Frame Finishing & Codes / Finiture Telai e Codici

cod.259.--/68NA chromed/cromata
cod.259.--/68NAB white/bianco

DKK - kr

1.395
1.595

SLOT FILL 78 BL



Techno-polymer seat,
wooden beech frame.
Seduta in tecnopolimero,
telaio in legno di faggio.

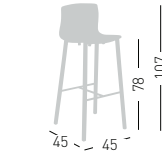

NA not assembled / non assemblato



0,19 m³ - 13,2 kg.
46x46x89cm.
2 pcs [carton]

Frame Finishing & Codes / Finiture Telai e Codici

cod.259.--/78BL_

DKK - kr

2.495

Felt Glides / Tappi in feltro

SLOT FILL 68 BL



Techno-polymer seat,
wooden beech frame.
Seduta in tecnopolimero,
telaio in legno di faggio.

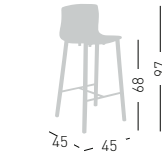
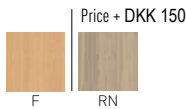

NA not assembled / non assemblato



0,19 m³ - 13 kg.
46x46x89cm.
2 pcs [carton]

Frame Finishing & Codes / Finiture Telai e Codici

cod.259.--/68BL_

DKK - kr

2.495

Felt Glides / Tappi in feltro

SLOT FILL AV



Techno-polymer seat,
chromed frame and base.
Seduta in tecnopolimero, telaio
e base cromata.

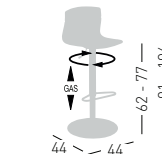

A assembled / assemblato



0,19 m³ - 12,0 kg.
46x46x89cm.
1 pcs [carton]

Frame Finishing & Codes / Finiture Telai e Codici

cod.259.--/AV chromed/cromata

DKK - kr

2.395

SLOT FILL AFV



Techno-polymer seat,
chromed frame and base.
Seduta in tecnopolimero, telaio
e base cromata.



NA not assembled / non assemblato



0,13 m³ - 12,0 kg.
42x42x77,5cm.
1 pcs [carton]

Frame Finishing & Codes / Finiture Telai e Codici

cod.259.--/AFV chromed/cromata

DKK - kr

2.095

SLOT UPHOLSTERED IMBOTTITI

Available coverings / Finiture disponibili
 Aurea eco-leather / Ecopelle aurea **E** (4pcs min.)
 King fabric / Tessuto King **K** (4pcs min.)
 Blazer fabric / Tessuto blazer **B** (4pcs min.)
 Kvadrat fabrics / Tessuti Kvadrat **DK** (4pcs min.)
 COM fabric / Tessuto cliente **TC** (10pcs min.)

SLOT 78 UPHOLSTERED



Fabric or leather upholstered seat, chromed or painted frame.
 Sgabello imbottito in tessuto o pelle e telaio in metallo cromato o verniciato.

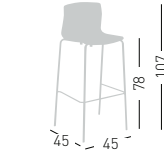

NA not assembled / non assemblato



0,41 m³ - 26 kg.
 50x50x49cm
 60x54x92cm
 4 pcs (carton)

Frame Finishing & Codes / Finiture Telai e Codici

cod.258.--/IE78NA chromed/cromata	DKK - kr	2.795
cod.258.--/IE78NAB white/bianco		2.895
cod.258.--/IK78NA chromed/cromata		2.795
cod.258.--/IK78NAB white/bianco		2.895
cod.258.--/IB78NA chromed/cromata		2.895
cod.258.--/IB78NAB white/bianco		3.095
cod.258.--/IDK78NA chromed/cromata		3.395
cod.258.--/IDK78NAB white/bianco		3.595
cod.258/ITC78NA chromed/cromata		2.595
cod.258/ITC78NAB white/bianco		2.795

Fabric required
 Fabbisogno di tessuto
 1 pcs: Lin Mtrs 0,9 (h1,40)

COM fabric min. order
 10pcs each code
 Tessuto cliente TC ordine
 min. 10pz per codice

Min. order 4pcs
 each code
 Ordine min 4pz
 per codice

SLOT 68 UPHOLSTERED



Fabric or leather upholstered seat, chromed or painted frame.
 Sgabello imbottito in tessuto o pelle e telaio in metallo cromato o verniciato.

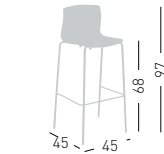

NA not assembled / non assemblato

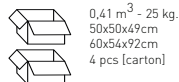

0,41 m³ - 25 kg.
 50x50x49cm
 60x54x92cm
 4 pcs (carton)

Frame Finishing & Codes / Finiture Telai e Codici

cod.258.--/IE68NA chromed/cromata	DKK - kr	2.795
cod.258.--/IE68NAB white/bianco		2.895
cod.258.--/IK68NA chromed/cromata		2.795
cod.258.--/IK68NAB white/bianco		2.895
cod.258.--/IB68NA chromed/cromata		2.895
cod.258.--/IB68NAB white/bianco		3.095
cod.258.--/IDK68NA chromed/cromata		3.395
cod.258.--/IDK68NAB white/bianco		3.595
cod.258/ITC68NA chromed/cromata		2.595
cod.258/ITC68NAB white/bianco		2.795

Fabric required
 Fabbisogno di tessuto
 1 pcs: Lin Mtrs 0,9 (h1,40)

COM fabric min. order
 10pcs each code
 Tessuto cliente TC ordine
 min. 10pz per codice

Min. order 4pcs
 each code
 Ordine min 4pz
 per codice

SLOT 78 BL UPHOLSTERED



Fabric or leather upholstered seat, wooden beech frame.
 Sgabello imbottito in tessuto o pelle, telaio in legno di faggio.

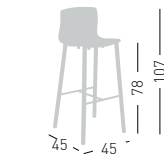

NA not assembled / non assemblato



0,19 m³ - 14,2 kg.
 46x46x89cm.
 2 pcs (carton)

Price + DKK 150

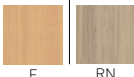

Frame Finishing & Codes / Finiture Telai e Codici

cod.258.--/IE78BL_	DKK - kr	3.895
cod.258.--/IK78BL_		3.895
cod.258.--/IB78BL_		4.095
cod.258.--/IDK78BL_		4.495
cod.258/ITC78BL_		3.595

Felt Glides / Tappi in feltro

Fabric required
 Fabbisogno di tessuto
 1 pcs: Lin Mtrs 0,9 (h1,40)

COM fabric min. order
 10pcs each code
 Tessuto cliente TC ordine
 min. 10pz per codice

Min. order 4pcs
 each code
 Ordine min 4pz
 per codice

SLOT 68 BL UPHOLSTERED



Fabric or leather upholstered seat, wooden beech frame.
 Sgabello imbottito in tessuto o pelle, telaio in legno di faggio.

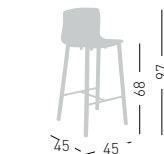

NA not assembled / non assemblato



0,19 m³ - 14 kg.
 46x46x89cm.
 2 pcs (carton)

Price + DKK 150



Frame Finishing & Codes / Finiture Telai e Codici

cod.258.--/IE68BL_	DKK - kr	3.895
cod.258.--/IK68BL_		3.895
cod.258.--/IB68BL_		4.095
cod.258.--/IDK68BL_		4.495
cod.258/ITC68BL_		3.595

Felt Glides / Tappi in feltro

Fabric required
 Fabbisogno di tessuto
 1 pcs: Lin Mtrs 0,9 (h1,40)

COM fabric min. order
 10pcs each code
 Tessuto cliente TC ordine
 min. 10pz per codice

Min. order 4pcs
 each code
 Ordine min 4pz
 per codice

**SLOT AV
UPHOLSTERED**



Stool upholstered in fabric or leather, chromed frame and base. Sgabello imbottito in tessuto o pelle, telaio e base cromata.

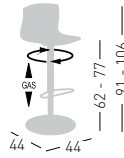

A assembled / assemblato



0,19 m³ - 12,0 kg.
46x46x89cm.
1 pcs [carton]

Frame Finishing & Codes / Finiture Telai e Codici

cod.258.--/IEAV chromed/cromata
cod.258.--/IKAV chromed/cromata
cod.258.--/IBAV chromed/cromata
cod.258.--/IDKAV chromed/cromata
cod.258.--/ITCAV chromed/cromata

DKK - kr

3.695
3.695
3.895
4.395
3.595

COM fabric min. order
10pcs each code
Tessuto cliente TC ordine
min. 10pz per codice

Min. order 4pcs
each code
Ordine min 4pz
per codice

**SLOT AFV
UPHOLSTERED**



Stool upholstered in fabric or leather, chromed frame and base. Sgabello imbottito in tessuto o pelle, telaio e base cromata.

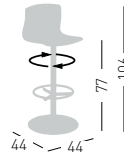

NA not assembled / non assemblato



0,13 m³ - 12,0 kg.
42x42x77,5cm.
1 pcs [carton]

Frame Finishing & Codes / Finiture Telai e Codici

cod.258.--/IEAFV chromed/cromata
cod.258.--/IKAFV chromed/cromata
cod.258.--/IBAFV chromed/cromata
cod.258.--/IDKAFV chromed/cromata
cod.258.--/ITCAFV chromed/cromata

DKK - kr

3.395
3.395
3.595
4.095
3.295

COM fabric min. order
10pcs each code
Tessuto cliente TC ordine
min. 10pz per codice

Min. order 4pcs
each code
Ordine min 4pz
per codice

Snack



Available colors / Colori disponibili

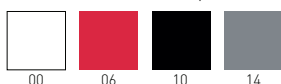

SNACK



Techno-polymer seat, chromed frame and combined base.
Seduta in tecnopolimero, telaio cromato e base abbinata.

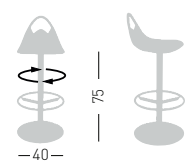

A assembled / assemblato



0,13 m³ - 10,5 kg.
42x42x77,5cm
1 pcs [carton]

Frame Finishing & Codes / Finiture Telaie e Codici

cod. 25.-- /A

Base color combined with the seat
Colore base abbinata alla seduta

DKK - kr

1.495

SNACK AV



Techno-polymer seat, chromed frame and chromed base.
Seduta in tecnopolimero, telaio cromato e base cromata.

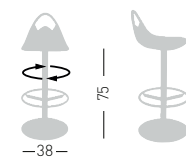

A assembled / assemblato



0,13 m³ - 11,5 kg.
42x42x77,5cm
1 pcs [carton]

Frame Finishing & Codes / Finiture Telaie e Codici

cod. 25.-- /AV chromed base/base cromata

DKK - kr

1.695

Spyker Stool

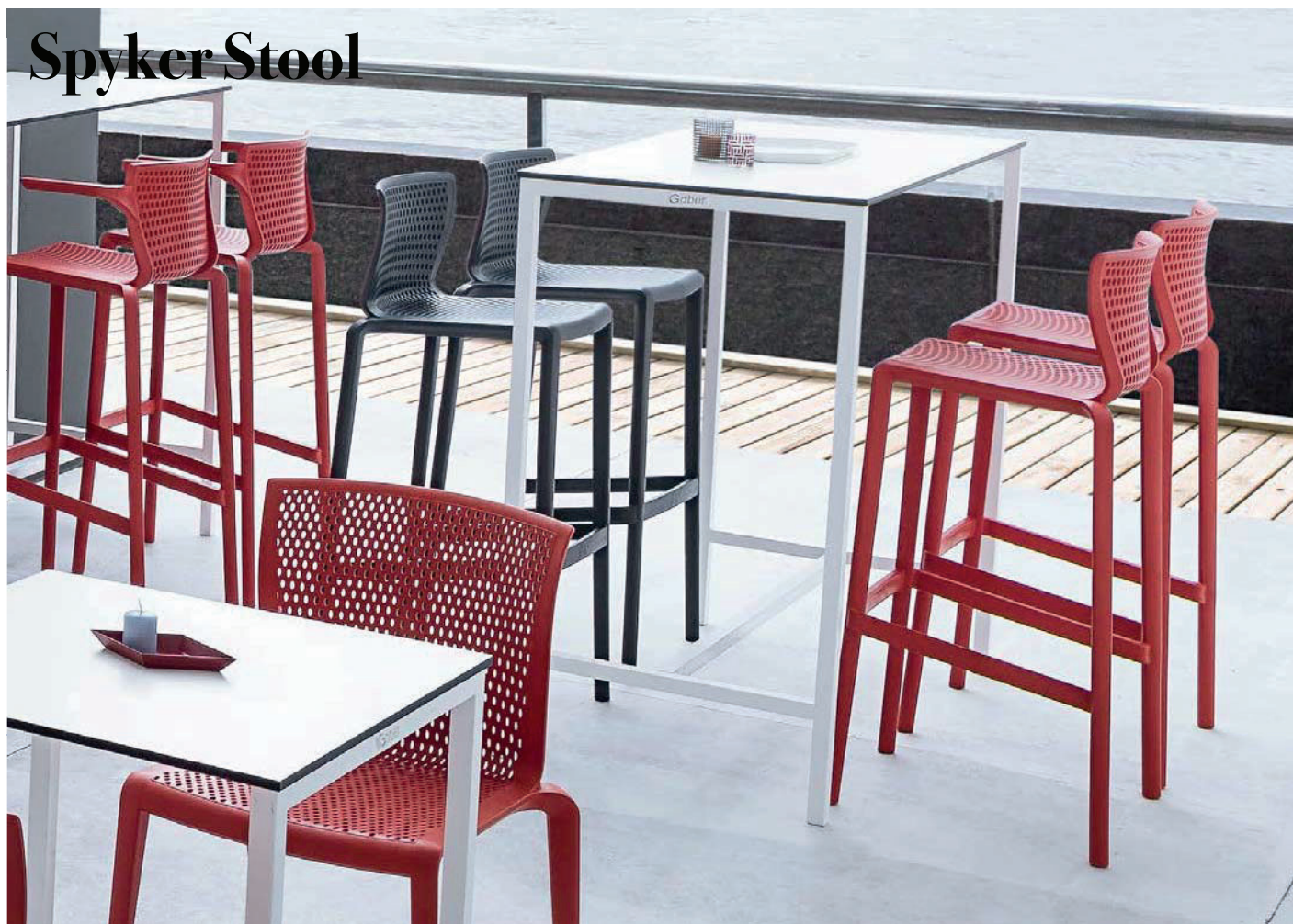

Available colors / Colori disponibili

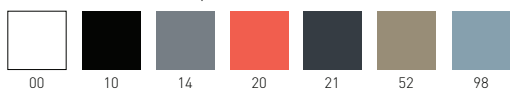

SPYKER STOOL

Stackable techno-polymer stool.
Sgabello impilabile in tecnopolimero.

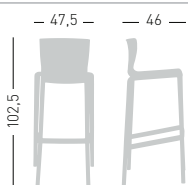

stackable / impilabile (6pcs)
A assembled / assemblato



0,37 m³ - 22,8 kg.
63x49x118cm
4 pcs [carton]

Frame Finishing & Codes / Finiture Telai e Codici

cod.227. __/76A

DKK - kr

1.095

SPYKER STOOL B

Stackable techno-polymer stool
with armrests.
Sgabello impilabile in tecnopolimero
con braccioli.

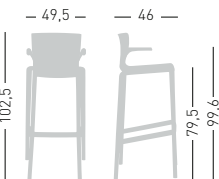

stackable / impilabile (6pcs)
A assembled / assemblato



0,37 m³ - 23,6 kg.
63x49x118cm
4 pcs [carton]

Frame Finishing & Codes / Finiture Telai e Codici

cod.228. __/76A

DKK - kr

1.295

Square



Available colors / Colori disponibili

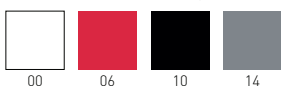

SQUARE



Techno-polymer seat, chromed frame and combined base. Seduta in tecnopolimero, telaio cromato e base abbinata.

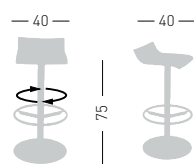

A assembled / assemblato

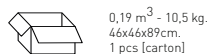

0,19 m³ - 10,5 kg.
46x46x89cm.
1 pcs (carton)

Frame Finishing & Codes / Finiture Telai e Codici

cod. 44.-- /A

Base color combined with the seat
Colore base abbinata alla seduta

DKK - kr

1.695

SQUARE AV



Techno-polymer seat, chromed frame and base. Seduta in tecnopolimero, telaio cromato e base cromata.

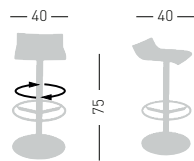

A assembled / assemblato



0,19 m³ - 11 kg.
46x46x89cm.
1 pcs (carton)

Frame Finishing & Codes / Finiture Telai e Codici

cod. 44.-- /AV chromed base/base cromata

DKK - kr

1.895



Available colors / Colori disponibili



SWING A



Techno-polymer seat with combined base, chromed frame.
Seduta in tecnopolimero con base abbinata, telaio cromato.

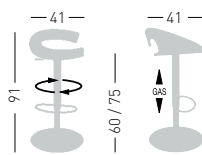

A assembled / assemblato



0,19 m³ - 12 kg.
46x46x89cm.
1 pcs [carton]

Frame Finishing & Codes / Finiture Telai e Codici

cod. 62.-- /A

Base color combined with the seat
Colore base abbinata alla seduta

DKK - kr

2.195

SWING AV



Techno-polymer seat, chromed frame and base.
Seduta in tecnopolimero, telaio cromato e base cromata.

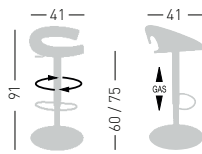

A assembled / assemblato



0,19 m³ - 12,5 kg.
46x46x89cm.
1 pcs [carton]

Frame Finishing & Codes / Finiture Telai e Codici

cod. 62.-- /AV chromed base/base cromata

DKK - kr

2.495



Available colors / Colori disponibili

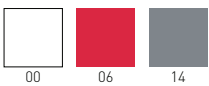

TOM



Techno-polymer seat, chromed frame and combined base. Seduta in tecnopolimero, telaio cromato e base abbinata.

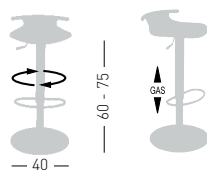

A assembled / assemblato



0,13 m³ - 11 kg.
77x42x42cm.
1 pcs (carton)

Frame Finishing & Codes / Finiture Telai e Codici

cod. 32.-- /A

Base color combined with the seat
Colore base abbinato alla seduta

DKK - kr

1.895

TOM AV



Techno-polymer seat, chromed frame and base. Seduta in tecnopolimero, telaio cromato e base cromata.

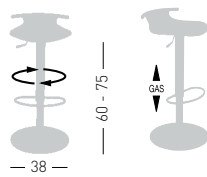

A assembled / assemblato



0,13 m³ - 12 kg.
42x42x77,5cm.
1 pcs (carton)

Frame Finishing & Codes / Finiture Telai e Codici

cod. 32.-- /AV chromed base/base cromata

DKK - kr

2.095



Available coverings / Finiture disponibili
Leather / Pelle **P** (4pcs min.)

TORINO I UPHOLSTERED



Techno-polymer seat upholstered in leather, chromed frame and coloured base.
Seduta in tecnopolimero rivestito in pelle, telaio cromato e base colorata.

Available fabric / Tessuti disponibili
Leather / Pelle **P**

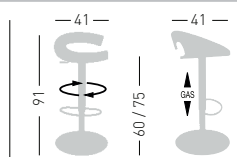

A assembled / assemblato



0,19 m³ - 12,5 kg.
46x46x89cm.
1 pcs [carton]

Frame Finishing & Codes / Finiture Telai e Codici

cod.62.--/IPA

Base color combined with the seat
Colore base abbinata alla seduta

DKK - kr

3.295

Min. order 4pcs
each code
Ordine min 4pz
per codice

TORINO IV UPHOLSTERED



Techno-polymer seat upholstered in leather, chromed frame and base.
Seduta in tecnopolimero rivestita in pelle, telaio e base cromata.

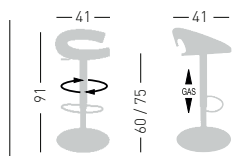

A assembled / assemblato



0,19 m³ - 13 kg.
46x46x89cm.
1 pcs [carton]

Frame Finishing & Codes / Finiture Telai e Codici

cod.62.--/IPAV chromed base/base cromata

DKK - kr

3.595

Min. order 4pcs
each code
Ordine min 4pz
per codice

TABLES Collection

Agile

Studio Eurolinea Design

The multifunctional Agile Table Collection reveals essential aesthetics.

Available with rectangular solid laminate tops, the Agile Collection utilizes techno-polymer legs in different colors, supported by a steel frame.

Agile è una collezione di tavoli multifunzionale dall'estetica ricercata ed essenziale.

Realizzato con piani rettangolari in laminato, Agile utilizza gambe in tecnopolimero in diverse colorazioni, supportate da una cornice in acciaio.



Technopolymer Frame Color / Colore: Struttura Tecnopolimero

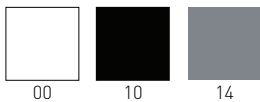

Laminated Top Color / Colore Piano Laminato



Special Finishes / Finiture Speciali

Laminated: Special Laminated Surfaces Wood Effect 25 (p. 383) available on demand
 Special Laminated Surfaces Wood Effect 25 (p. 383) disponibile su richiesta
 Special Laminated Surfaces Fenix 25 (p. 384) available on demand
 Special Laminated Surfaces Fenix 25 (p. 384) disponibile su richiesta

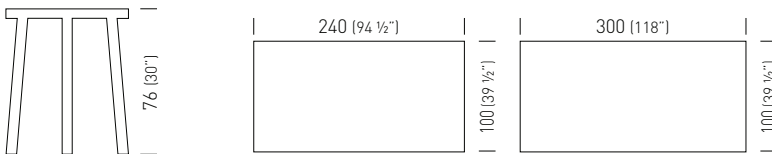

100x240laminated	TAGIL250._._/6H75		0.70m ³ / 50kg / 1pcs	DKK - kr	14.195
100x300laminated	TAGIL254._._/6H75		0.90m ³ / 60kg / 1pcs		17.695

Aprio

Forsix Design



Frame Color / Colore Struttura



00



10

Compactop Color / Colore Piano Compactop

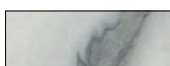

5547



6076

Aprio is an extendable rectangular garden table, with an epoxy powder coated aluminum frame and compact laminate top. Thanks to the construction materials and the telescopic extending frame, integrated with the legs, the table lends itself perfectly to both indoor and outdoor use. The patented extension system allows the structure to slide, keeping the legs always at the ends of the table. A quick coupling system allows easy extension by inserting one or two of the leaves that are hidden within the frame itself.

Aprio è un tavolo da giardino rettangolare allungabile, con struttura in alluminio verniciato a polveri epossidiche e piano in Compactop. Grazie ai materiali di costruzione e alla struttura telescopica di allungo, solidale con la gamba, il tavolo si presta perfettamente all'utilizzo sia indoor che outdoor. Il sistema brevettato di allungo consente lo scorrimento della struttura, mantenendo le gambe sempre alle estremità del tavolo. E' possibile scegliere di allungare il tavolo aggiungendo con facilità una o due prolunghe, completamente nascoste all'interno della struttura, grazie ad un sistema di aggancio rapido.

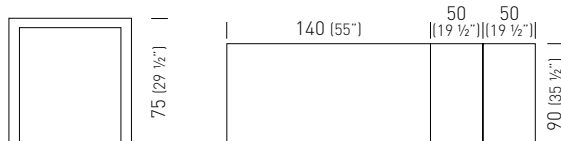

140+50+50x90

TAPRC417. __-__ /H75



0.90m³ / 48kg / 1pcs DKK - kr

23.995

Arket

Studio Eurolinea Design

The new Arket table collection is made using basic geometrics - radii and linear sections intersect to achieve distinctly intuitive shapes.

The aluminum bases have three or four spokes with adjustable feet, and the stems come in sections with three or four surfaces.

The table tops are made of steel: the tables are thus painted in a solid color and easily customizable and adaptable to the most prestigious of installations.

La nuova collezione di tavoli Arket è realizzata utilizzando le geometrie più elementari, raggi e sezioni lineari si intersecano per ricavare forme essenziali ed intuitive.

I basamenti, a tre o quattro razze, con piedini regolabili, e gli steli, a sezioni con tre o quattro superfici, sono realizzati in alluminio.

I piani sono realizzati in acciaio: i tavoli sono così verniciati in tinta unita e facilmente personalizzabili ed adattabili alle più prestigiose installazioni.



Colors / Colori

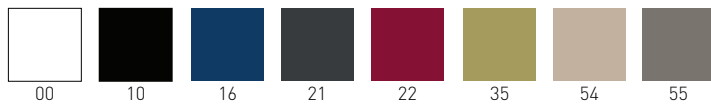

Stem Height	Top Diameter	Model	Material	Weight	Price
50 (19 1/2")	diam.60	TAK3I030._._/H50	0.075m ³ / 10kg / 1pcs	DKK - kr	2.395
	diam.70	TAK3I032._._/H50	0.085m ³ / 10.5kg / 1pcs		2.495
	60x60	TAK4I031._._/H50	0.075m ³ / 12kg / 1pcs		2.495
	70x70	TAK4I033._._/H50	0.085m ³ / 13.5kg / 1pcs		2.695
74 (29")	diam.60	TAK3I030._._/H74	0.075m ³ / 10.5kg / 1pcs		2.395
	diam.70	TAK3I032._._/H74	0.085m ³ / 11kg / 1pcs		2.595
	60x60	TAK4I031._._/H74	0.075m ³ / 12.5kg / 1pcs		2.595
	70x70	TAK4I033._._/H74	0.085m ³ / 14kg / 1pcs		2.695

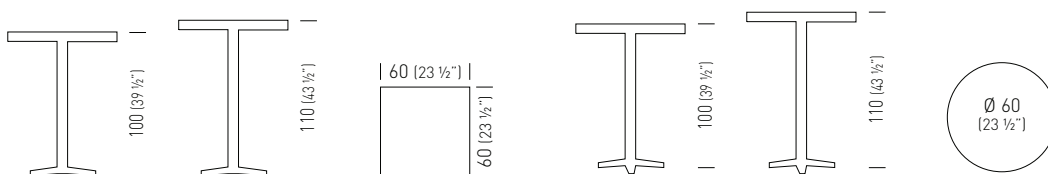

Stem Height	Top Diameter	Model	Material	Weight	Price
100 (39 1/2")	diam.60	TAK3I030._._/H100	0.105m ³ / 11kg / 1pcs		2.795
	60x60	TAK4I031._._/H100	0.105m ³ / 13kg / 1pcs		2.995
110 (43 1/2")	diam.60	TAK3I030._._/H110	0.105m ³ / 11kg / 1pcs		2.795
	60x60	TAK4I031._._/H110	0.105m ³ / 13kg / 1pcs		2.995

Arket Porcelain

Forsix Design



The Porcelain stoneware tops stand out for their excellent technical performance, ideal for the most delicate uses where maximum hygiene and resistance must be guaranteed. Porcelain tops are compatible with foodstuffs, resistant to fungi and molds, suitable for both indoor and outdoor use, resistant to frost, heat and high temperatures, they can be cleaned very easily while maintaining the characteristics of the surface.

I piani in Gres Porcellanato si distinguono per le eccellenti performance tecniche, ideali negli impieghi più delicati nei quali è necessario garantire la massima igiene e resistenza. I piani Porcelain sono compatibili con le sostanze alimentari, resistenti a funghi e muffe, idonei ad un utilizzo sia interno che esterno, resistenti al gelo, al calore e alle alte temperature, si possono pulire con estrema facilità mantenendo inalterate le caratteristiche della superficie.

Frame Color / Colore Struttura

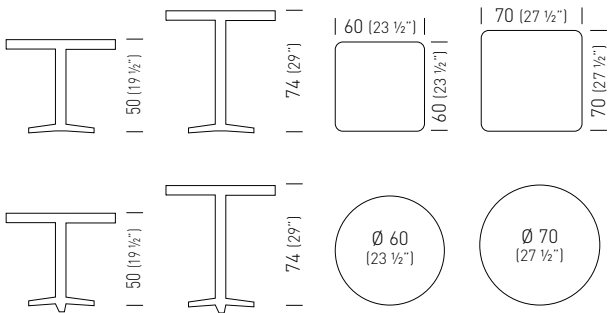
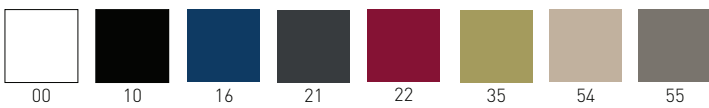

diam.60	TAK3P134.____/H50		0.57m ³ / 19.5kg / 1pc	DKK - kr	6.595
diam.70	TAK3P136.____/H50		0.57m ³ / 22.5kg / 1pc		7.395
60x60	TAK4P135.____/H50		0.57m ³ / 22.5kg / 1pc		5.995
70x70	TAK4P137.____/H50		0.57m ³ / 25.5kg / 1pc		7.495
diam.60	TAK3P134.____/H74		0.57m ³ / 20kg / 1pc		6.595
diam.70	TAK3P136.____/H74		0.57m ³ / 23kg / 1pc		7.395
60x60	TAK4P135.____/H74		0.57m ³ / 23kg / 1pc		5.995
70x70	TAK4P137.____/H74		0.57m ³ / 26kg / 1pc		7.495

Min. order 10pcs
each code
Ordine min 10pz
per codice

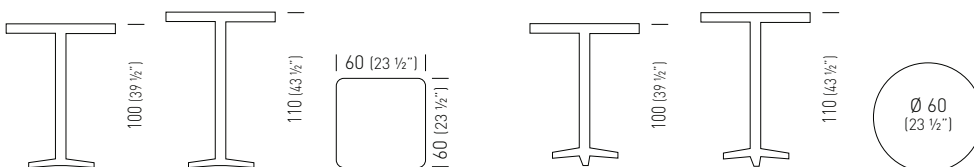

diam.60	TAK3P134.____/H100		0.60m ³ / 20.1kg / 1pcs		6.695
60x60	TAK4P135.____/H100		0.60m ³ / 23.1kg / 1pcs		6.095
diam.60	TAK3P134.____/H110		0.60m ³ / 20.2kg / 1pcs		6.695
60x60	TAK4P135.____/H110		0.60m ³ / 23.2kg / 1pcs		6.095

Min. order 10pcs
each code
Ordine min 10pz
per codice

Arket Plus

Forsix Design

Arket Plus Collection is made using basic geometrics, achieving distinctly intuitive shapes. The table tops are made of steel, the three spokes bases are made of co-injected metal and technopolymer. Stem and cross are made in aluminum, and provided with flip-top joint. The shape of the base and the flip-top mechanism allow the table to easily fold and stack, space-saving.

La Collezione di tavoli Arket Plus è realizzata utilizzando le geometrie più elementari, ottenendo così forme essenziali ed intuitive. I piani del tavolo sono realizzati in acciaio, la base a tre razze è costituita da una struttura in metallo co-iniettata con tecnopolimero. Colonna e crociera sono realizzate in alluminio, dotate di giunto per la rotazione del piano. La forma della base e la meccanica che permette la rotazione del piano rendono il tavolo facilmente accatastabile in spazi ridotti.



Colors / Colori

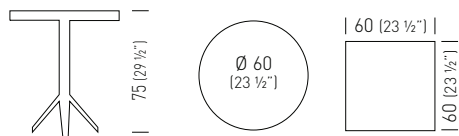
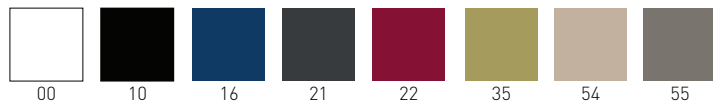

diam.60

TAKPI030._-_/H75



0.133m³ / 11.5kg / 1pcs

DKK - kr

2.595

60x60

TAKPI031._-_/H75



0.133m³ / 13.1kg / 1pcs

2.795

Azione Adjustable Desk

Forsix Design



"Azione", Sit-Stand desk table, height adjustable, equipped with bluetooth controller and anti-collision technology.
 "Azione", tavolo scrivania Sit-Stand, regolabile elettricamente in altezza, dotato di controller bluetooth e tecnologia anticollisione.

Frame Color / Colore Struttura

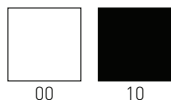

Laminated Top Color / Colore Piano Laminato

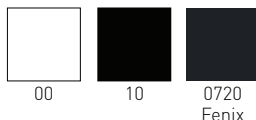

EN60335-1

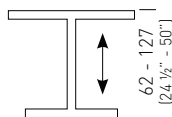

140 (55")	160 (63")	180 (71")
80 (31 1/2")	80 (31 1/2")	80 (31 1/2")
140 (55")	160 (63")	180 (71")
90 (35 1/2")	90 (35 1/2")	90 (35 1/2")

80x140laminated	TAZNL450.____-_/H62R	0.67m³ / 26kg / 1pcs	DKK - kr	12.895
80x140lam.fenix	TAZNL450.0720-_/H62R	0.67m³ / 26kg / 1pcs		14.995
80x160laminated	TAZNL451.____-_/H62R	0.70m³ / 28kg / 1pcs		13.195
80x160lam.fenix	TAZNL451.0720-_/H62R	0.70m³ / 28kg / 1pcs		15.695
80x180laminated	TAZNL452.____-_/H62R	0.75m³ / 30kg / 1pcs		13.495
80x180lam.fenix	TAZNL452.0720-_/H62R	0.75m³ / 30kg / 1pcs		16.195
90x140laminated	TAZNL453.____-_/H62R	0.70m³ / 28kg / 1pcs		13.195
90x140lam.fenix	TAZNL453.0720-_/H62R	0.70m³ / 28kg / 1pcs		15.595
90x160laminated	TAZNL454.____-_/H62R	0.75m³ / 30kg / 1pcs		13.495
90x160lam.fenix	TAZNL454.0720-_/H62R	0.75m³ / 30kg / 1pcs		16.195
90x180laminated	TAZNL455.____-_/H62R	0.80m³ / 33kg / 1pcs		13.795
90x180lam.fenix	TAZNL455.0720-_/H62R	0.80m³ / 33kg / 1pcs		16.795

Banket

Studio Eurolinea Design

High table, Compactop or Laminated table top, painted metal frame.

Tavolo alto con struttura in metallo verniciato, piano in Compactop o Laminato.



Only for Compactop
Solo per Compactop



Frame Color / Colore Struttura

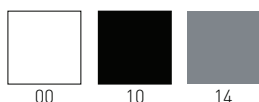

Compactop Color / Colore Piano Compactop

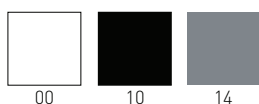

Laminated Top Color / Colore Piano Laminato



Special Finishes / Finiture Speciali

Compactop: Special Compactop Surfaces Fullcolor (p. 377) available on demand (min. 5pcs each code).
Special Compactop Surfaces Fullcolor (p. 377) disponibile su richiesta (min. 5pcs per codice).

Special Compactop Surfaces 10 (p. 378) available on demand (min. 20pcs each code).

Special Compactop Surfaces 10 (p. 378) disponibile su richiesta (min. 20pcs per codice).

Laminated: Special Laminated Surfaces Wood Effect 25 (p. 383) available on demand (min. 20pcs each code).

Special Laminated Surfaces Wood Effect 25 (p.383) disponibile su richiesta (min. 20pcs per codice).

Special Laminated Surfaces Fenix 25 (p. 384) available on demand (min. 20pcs each code).

Special Laminated Surfaces Fenix 25 (p. 384) disponibile su richiesta (min. 20pcs per codice).

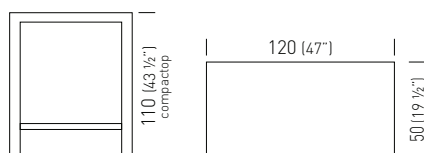

120x50compactop
120x50laminated

TBNKC800. __-__ /H110
TBNKL804. __-__ /H110

0.47m³ / 18kg / 1pcs
 0.47m³ / 18kg / 1pcs

DKK - kr

4.795
4.295

Bristol

Forsix Design



Only Steel and Compactop
Solo piani Acciaio e Compactop

The Bristol table is characterized by bold lines and tone-on-tone colours, suitable for setting off to a tee the most refined hospitality environments. Its top and four-spur base, equipped with adjustable feet, are in epoxy powder coated steel treated for outdoor use. Il tavolo Bristol è caratterizzato da linee decise e dai colori tono su tono, adatto a diventare protagonista degli ambienti dell'ospitalità più ricercati. Il piano e il basamento a quattro razze, dotato di piedini regolabili, sono realizzati in acciaio verniciato a polveri epossidiche con trattamento per esterno.

Frame Color / Colore Struttura

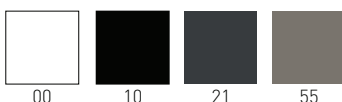

Compactop Color / Colore Piano Compactop



Laminated Top Color / Colore Piano Laminato



Steel Top Color / Colore Piano Acciaio

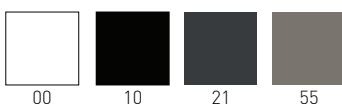

Special Finishes / Finiture Speciali

Compactop: Special Compactop Surfaces Fullcolor (p. 377) available on demand (min. 5pcs each code).
Special Compactop Surfaces Fullcolor (p. 377) disponibile su richiesta (min. 5pcs per codice).
Special Compactop Surfaces Fenix (p. 380) available on demand (min. 20pcs each code).
Special Compactop Surfaces Fenix (p. 380) disponibile su richiesta (min. 20pcs per codice).
Special Compactop Surfaces 10 (p. 378) available on demand (min. 20pcs each code).
Special Compactop Surfaces 10 (p. 378) disponibile su richiesta (min. 20pcs per codice).

Laminated: Special Laminated Surfaces Wood Effect (p. 383) available on demand (min. 20pcs each code).
Special laminated Surfaces Wood Effect (p. 383) disponibile su richiesta (min. 20pcs per codice).
Special Laminated Surfaces Fenix (p. 384) available on demand (min. 20pcs each code).
Special laminated Surfaces Fenix (p. 384) disponibile su richiesta (min. 20pcs per codice).

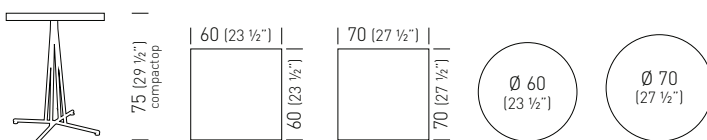

60x60 laminated	TBRSL383.___/H75		0.28m ³ / 15kg / 1pc	DKK - kr	2.795
70x70 laminated	TBRSL385.___/H75		0.30m ³ / 18kg / 1pc		2.895
diam.60 laminated	TBRSL382.___/H75		0.28m ³ / 14kg / 1pc		2.895
diam.70 laminated	TBRSL384.___/H75		0.30m ³ / 15kg / 1pc		3.095
60x60 compactop	TBRSC363.___/H75		0.28m ³ / 14.5kg / 1pc		2.995
70x70 compactop	TBRSC369.___/H75		0.30m ³ / 18kg / 1pc		3.195
diam.60 compactop	TBRSC360.___/H75		0.28m ³ / 14kg / 1pc		3.295
diam.70 compactop	TBRSC366.___/H75		0.30m ³ / 15kg / 1pc		3.595
60x60 steel	TBRSI377.___/H75		0.28m ³ / 16kg / 1pc		3.195
70x70 steel	TBRSI379.___/H75		0.30m ³ / 21kg / 1pc		3.395
diam.60 steel	TBRSI376.___/H75		0.28m ³ / 14kg / 1pc		3.195
diam.70 steel	TBRSI378.___/H75		0.30m ³ / 18kg / 1pc		3.395

Charme

Studio Eurolinea Design

Elegance and essential shapes find a new expression in the Charme table, a proposal designed for workspace and hospitality environments, which is characterized by the particular design of the metal legs.

The regular shapes harmonize each other, creating a product also suitable for conviviality, thanks to the top in "Iron" composite material which highlights great stability and resistance.

Eleganza ed essenzialità trovano una nuova espressione nel tavolo Charme, una proposta ideata per lo spazio di lavoro e dell'ospitalità, che si caratterizza per il particolare design delle gambe in metallo.

Le forme regolari si armonizzano tra loro, dando vita a un progetto improntato anche alla convivialità, grazie al piano in materiale composito "Iron" dalla grande stabilità e resistenza.



Colors / Colori

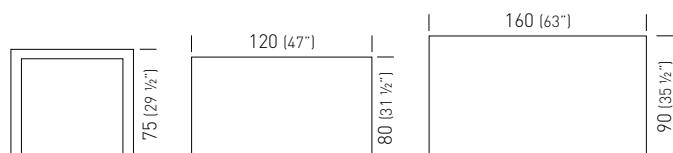
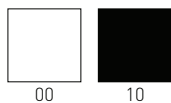

80x120
90x160

TCHAI400._/H75
TCHAI402._/H75



0.48m³ / 20kg / 1pcs
0.72m³ / 22kg / 1pcs

DKK - kr

8.495
10.695



Claro

Studio Eurolinea Design



Table with co-injected metal frame with techno polymer, Compactop or laminated top. Suitable for outdoor purpose with Compactop.

Tavolo con struttura in metallo sovrastampato con tecnopolimero, piano in Compactop o laminato.

Con piano Compactop, adatto anche all'uso esterno.



Only for Compactop
Solo per Compactop



Frame Color / Colore Struttura

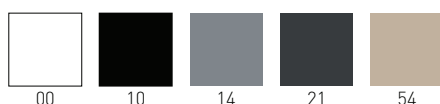

Compactop Color / Colore Piano Compactop

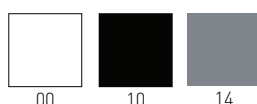

Laminated Top Color / Colore Piano Laminato



Special Finishes / Finiture Speciali

Compactop Special Compactop Surfaces 10 (p. 378) available on demand (min. 20pcs each code).
Special Compactop Surfaces 10 (p. 378) disponibile su richiesta (min. 20pcs per codice).
Laminated: Special Laminated Surfaces Wood Effect 25 (p. 383) available on demand (min. 20pcs each code).
Special Laminated Surfaces Wood Effect 25 (p. 383) disponibile su richiesta (min. 20pcs per codice).
Special Laminated Surfaces Fenix 25 (p. 384) available on demand (min. 20pcs each code).
Special Laminated Surfaces Fenix 25 (p. 384) disponibile su richiesta (min. 20pcs per codice).

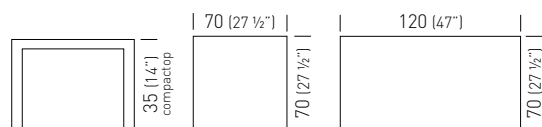

70x70compactop	TCLAC570.__-_/H35		0.24m ³ / 20kg / 1pcs	DKK - kr	2.995
70x70laminated	TCLAL580.__-_/H35		0.24m ³ / 20kg / 1pcs		2.795
70x70fullcolor (min 5pcs)	TCLAC571.00-_/H35		0.24m ³ / 20kg / 1pcs		3.395
70x120compactop	TCLAC572.__-_/H35		0.36m ³ / 25kg / 1pcs		4.495
70x120laminated	TCLAL582.__-_/H35		0.36m ³ / 25kg / 1pcs		4.195
70x120fullcolor (min 5pcs)	TCLAC573.00-_/H35		0.36m ³ / 25kg / 1pcs		5.095

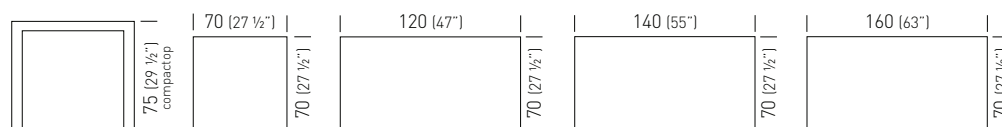

70x70compactop	TCLAC570.__-_/H75		0.24m ³ / 22kg / 1pcs		2.995
70x70laminated	TCLAL580.__-_/H75		0.24m ³ / 22kg / 1pcs		2.795
70x70fullcolor (min 5pcs)	TCLAC571.00-_/H75		0.24m ³ / 22kg / 1pcs		3.395
70x120compactop	TCLAC572.__-_/H75		0.36m ³ / 27kg / 1pcs		4.495
70x120laminated	TCLAL582.__-_/H75		0.36m ³ / 27kg / 1pcs		4.195
70x120fullcolor (min 5pcs)	TCLAC573.00-_/H75		0.36m ³ / 27kg / 1pcs		5.095
70x140compactop	TCLAC574.__-_/H75		0.41m ³ / 31kg / 1pcs		5.695
70x140laminated	TCLAL584.__-_/H75		0.41m ³ / 31kg / 1pcs		5.395
70x140fullcolor (min 5pcs)	TCLAC575.00-_/H75		0.41m ³ / 31kg / 1pcs		6.595
70x160compactop	TCLAC576.__-_/H75		0.46m ³ / 35kg / 1pcs		6.995
70x160laminated	TCLAL586.__-_/H75		0.46m ³ / 35kg / 1pcs		6.495
70x160fullcolor (min 5pcs)	TCLAC577.00-_/H75		0.46m ³ / 35kg / 1pcs		8.095

Claro

Studio Eurolinea Design



Only for Compactop
Solo per Compactop



Frame Color / Colore Struttura

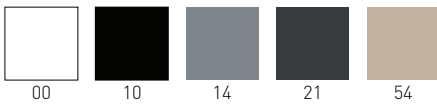

Compactop Color / Colore Piano Compactop

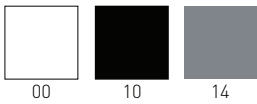

Laminated Top Color / Colore Piano Laminato



Special Finishes / Finiture Speciali

Compactop Special Compactop Surfaces 10 (p. 378) available on demand (min. 20pcs each code).
Special Compactop Surfaces 10 (p. 378) disponibile su richiesta (min. 20pcs per codice).
Laminated: Special Laminated Surfaces Wood Effect 25 (p. 383) available on demand (min. 20pcs each code)
Special Laminated Surfaces Wood Effect 25 (p. 383) disponibile su richiesta (min. 20pcs per codice)
Special Laminated Surfaces Fenix 25 (p. 384) available on demand (min. 20pcs each code)
Special Laminated Surfaces Fenix 25 (p. 384) disponibile su richiesta (min. 20pcs per codice)

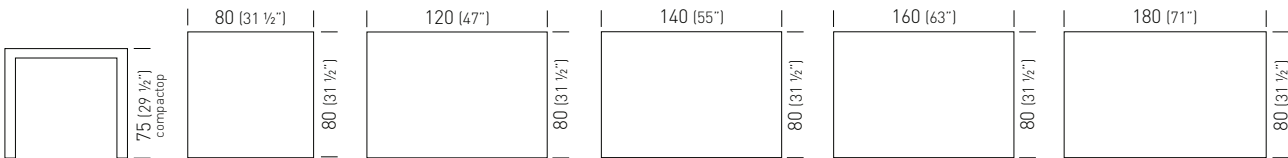

80x80compactop	TCLAC590. __-__ /H75		0.24m ³ / 31kg / 1pcs	DKK - kr	3.295
80x80laminated	TCLAL600. __-__ /H75		0.24m ³ / 31kg / 1pcs		3.095
80x80fullcolor (min 5pcs)	TCLAC591.00-__ /H75		0.24m ³ / 31kg / 1pcs		3.795
80x120compactop	TCLAC592. __-__ /H75		0.36m ³ / 38kg / 1pcs		4.795
80x120laminated	TCLAL602. __-__ /H75		0.36m ³ / 38kg / 1pcs		4.495
80x120fullcolor (min 5pcs)	TCLAC593.00-__ /H75		0.36m ³ / 38kg / 1pcs		5.495
80x140compactop	TCLAC594. __-__ /H75		0.41m ³ / 40kg / 1pcs		6.095
80x140laminated	TCLAL604. __-__ /H75		0.41m ³ / 40kg / 1pcs		5.695
80x140fullcolor (min 5pcs)	TCLAC595.00-__ /H75		0.41m ³ / 40kg / 1pcs		6.995
80x160compactop	TCLAC596. __-__ /H75		0.46m ³ / 42kg / 1pcs		7.295
80x160laminated	TCLAL606. __-__ /H75		0.46m ³ / 42kg / 1pcs		6.895
80x160fullcolor (min 5pcs)	TCLAC597.00-__ /H75		0.46m ³ / 42kg / 1pcs		8.495
80x180compactop	TCLAC598. __-__ /H75		0.60m ³ / 44kg / 1pcs		8.195
80x180laminated	TCLAL608. __-__ /H75		0.60m ³ / 44kg / 1pcs		7.495
80x180fullcolor (min 5pcs)	TCLAC599.00-__ /H75		0.60m ³ / 44kg / 1pcs		9.495



Only for Compactop
Solo per Compactop

Frame Color / Colore Struttura

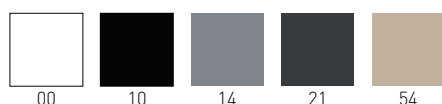

Compactop Color / Colore Piano Compactop



Laminated Top Color / Colore Piano Laminato



Special Finishes / Finiture Speciali

Compactop Special Compactop Surfaces 10 (p. 378) available on demand (min. 20pcs each code).
Special Compactop Surfaces 10 (p. 378) disponibile su richiesta (min. 20pcs per codice).
Laminated: Special Laminated Surfaces Wood Effect 25 (p. 383) available on demand (min. 20pcs each code).
Special Laminated Surfaces Wood Effect 25 (p. 383) disponibile su richiesta (min. 20pcs per codice).
Special Laminated Surfaces Fenix 25 (p. 384) available on demand (min. 20pcs each code).
Special Laminated Surfaces Fenix 25 (p. 384) disponibile su richiesta (min. 20pcs per codice).

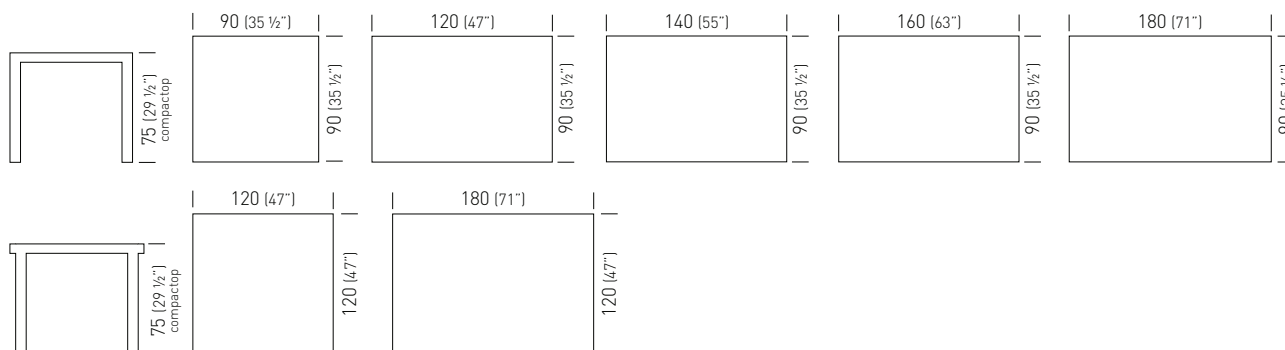

Table Size	Code	Icon	Volume / Weight	DKK - kr	Price
90x90compactop	TCLAC610.___/H75		0.54m ³ / 33kg / 1pcs		4.695
90x90laminated	TCLAL620.___/H75		0.54m ³ / 33kg / 1pcs		4.495
90x90fullcolor (min 5pcs)	TCLAC611.00-_/H75		0.54m ³ / 33kg / 1pcs		5.295
90x120compactop	TCLAC612.___/H75		0.54m ³ / 36kg / 1pcs		5.895
90x120laminated	TCLAL622.___/H75		0.54m ³ / 36kg / 1pcs		5.595
90x120fullcolor (min 5pcs)	TCLAC613.00-_/H75		0.54m ³ / 36kg / 1pcs		6.695
90x140compactop	TCLAC614.___/H75		0.65m ³ / 39kg / 1pcs		7.295
90x140laminated	TCLAL624.___/H75		0.65m ³ / 39kg / 1pcs		6.995
90x140fullcolor (min 5pcs)	TCLAC615.00-_/H75		0.65m ³ / 39kg / 1pcs		8.395
90x160compactop	TCLAC616.___/H75		0.75m ³ / 41kg / 1pcs		8.795
90x160laminated	TCLAL626.___/H75		0.75m ³ / 41kg / 1pcs		8.295
90x160fullcolor (min 5pcs)	TCLAC617.00-_/H75		0.75m ³ / 41kg / 1pcs		9.995
90x180compactop	TCLAC618.___/H75		0.80m ³ / 43kg / 1pcs		9.495
90x180laminated	TCLAL628.___/H75		0.80m ³ / 43kg / 1pcs		8.795
90x180fullcolor (min 5pcs)	TCLAC619.00-_/H75		0.80m ³ / 43kg / 1pcs		10.895
120x120laminated	TCLAL670.___/H75		0.70m ³ / 38kg / 1pcs		6.995
120x180laminated	TCLAL672.___/H75		1.00m ³ / 45kg / 1pcs		10.395

Claro Slim

Studio Eurolinea Design

Table with co-injected metal frame with techno polymer, Compactop or laminated top. Suitable for outdoor purpose with Compactop.

Tavolo con struttura in metallo sovrastampato con tecnopolimero, piano in Compactop o laminato. Con piano Compactop, adatto anche all'uso esterno.



Only for Compactop
Solo per Compactop



Frame Color / Colore Struttura

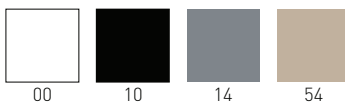

Compactop Color / Colore Piano Compactop

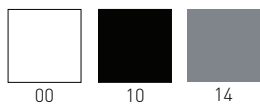

Laminated Top Color / Colore Piano Laminato



Special Finishes / Finiture Speciali

Compactop: Special Compactop Surfaces 10 (p. 378) available on demand (min. 20pcs each code)
Special Compactop Surfaces 10 (p. 378) disponibile su richiesta (min. 20pcs per codice).
Laminated: Special Laminated Surfaces Wood Effect 25 (p. 383) available on demand (min. 20pcs each code)
Special Laminated Surfaces Wood Effect 25 (p. 383) disponibile su richiesta (min. 20pcs per codice)
Special Laminated Surfaces Fenix 25 (p. 384) available on demand (min. 20pcs each code)
Special Laminated Surfaces Fenix 25 (p. 384) disponibile su richiesta (min. 20pcs per codice)

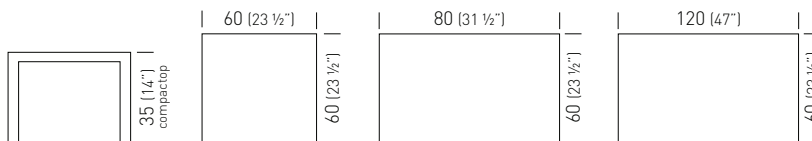

60x60compactop	TCLAC640. __-__ /H35		0.15m ³ / 17kg / 1pcs	DKK - kr	2.495
60x60laminated	TCLAL650. __-__ /H35		0.15m ³ / 17kg / 1pcs		2.395
60x60fullcolor (min 5pcs)	TCLAC641.00-__ /H35		0.15m ³ / 17kg / 1pcs		2.895
60x80compactop	TCLAC642. __-__ /H35		0.18m ³ / 19kg / 1pcs		2.695
60x80laminated	TCLAL652. __-__ /H35		0.18m ³ / 19kg / 1pcs		2.595
60x80fullcolor (min 5pcs)	TCLAC643.00-__ /H35		0.18m ³ / 19kg / 1pcs		3.195
60x120compactop	TCLAC644. __-__ /H35		0.36m ³ / 23kg / 1pcs		4.095
60x120laminated	TCLAL654. __-__ /H35		0.36m ³ / 23kg / 1pcs		3.995
60x120fullcolor (min 5pcs)	TCLAC645.00-__ /H35		0.36m ³ / 23kg / 1pcs		4.795

Claro Slim

Studio Eurolinea Design



Only for Compactop
Solo per Compactop

Frame Color / Colore Struttura

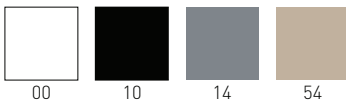

Compactop Color / Colore Piano Compactop

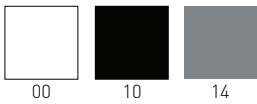

Laminated Top Color / Colore Piano Laminato



Special Finishes / Finiture Speciali

Compactop: Special Compactop Surfaces 10 (p. 378) available on demand (min. 20pcs each code)
Special Compactop Surfaces 10 (p. 378) disponibile su richiesta (min. 20pcs per codice)
Laminated: Special Laminated Surfaces Wood Effect 25 (p. 383) available on demand (min. 20pcs each code)
Special Laminated Surfaces Wood Effect 25 (p. 383) disponibile su richiesta (min. 20pcs per codice)
Special Laminated Surfaces Fenix 25 (p. 384) available on demand (min. 20pcs each code)
Special Laminated Surfaces Fenix 25 (p. 384) disponibile su richiesta (min. 20pcs per codice)

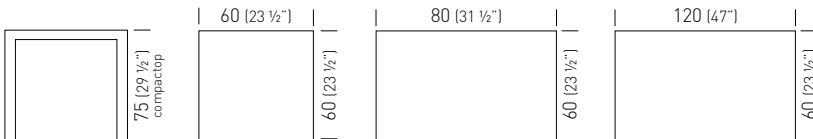

60x60compactop	TCLAC640.___/_/H75		0.15m ³ / 19kg / 1pcs	DKK - kr	2.595
60x60laminated	TCLAL650.___/_/H75		0.15m ³ / 19kg / 1pcs		2.495
60x60fullcolor (min 5pcs)	TCLAC641.00-___/H75		0.15m ³ / 19kg / 1pcs		2.995
60x80compactop	TCLAC642.___/_/H75		0.18m ³ / 21kg / 1pcs		2.795
60x80laminated	TCLAL652.___/_/H75		0.18m ³ / 21kg / 1pcs		2.695
60x80fullcolor (min 5pcs)	TCLAC643.00-___/H75		0.18m ³ / 21kg / 1pcs		3.195
60x120compactop	TCLAC644.___/_/H75		0.36m ³ / 25kg / 1pcs		4.195
60x120laminated	TCLAL654.___/_/H75		0.36m ³ / 25kg / 1pcs		3.995
60x120fullcolor (min 5pcs)	TCLAC645.00-___/H75		0.36m ³ / 25kg / 1pcs		4.795

Claro Slim

Studio Eurolinea Design

High table, Compactop or Laminated table top, painted metal frame.
Tavolo alto con struttura in metallo verniciato, piano in Compactop o Laminato.



Only for Compactop
Solo per Compactop



Frame Color / Colore Struttura

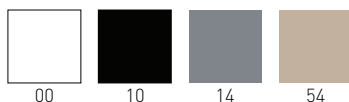

Compactop Color / Colore Piano Compactop

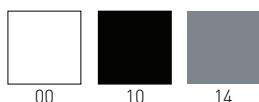

Laminated Top Color / Colore Piano Laminato



Special Finishes / Finiture Speciali

Compactop: Special Compactop Surfaces 10 (p. 325) available on demand (min. 20pcs each code)
Special Compactop Surfaces 10 (p. 325) disponibile su richiesta (min. 20pcs per codice)

Laminated: Special Laminated Surfaces Wood Effect 25 (p. 383) available on demand (min. 20pcs each code)
Special Laminated Surfaces Wood Effect 25 (p. 383) disponibile su richiesta (min. 20pcs per codice)
Special Laminated Surfaces Fenix 25 (p. 384) available on demand (min. 20pcs each code)
Special Laminated Surfaces Fenix 25 (p. 384) disponibile su richiesta (min. 20pcs per codice)

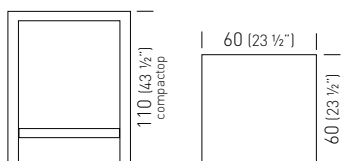

60x60compactop
60x60laminated
60x60fullcolor (min 5pcs)

TCLAC640. __-__ /H110 0.20m³ / 21kg / 1pcs
TCLAL650. __-__ /H110 0.20m³ / 21kg / 1pcs
TCLAC641.00-__ /H110 0.20m³ / 21kg / 1pcs

DKK - kr

3.095
2.995
3.495

Flipaway

Forsix Design



"Flipaway" table for conference environment, provided with laminated table top and breaking castors, ensures complete frontal stackability.

"Flipaway": tavolo con piano in laminato adatto ad ambienti conferenza, accatastabile frontalmente e dotato di ruote con freno.



Frame Color / Colore Struttura

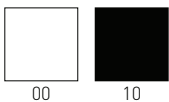

Laminated Top Color / Colore Piano Laminato

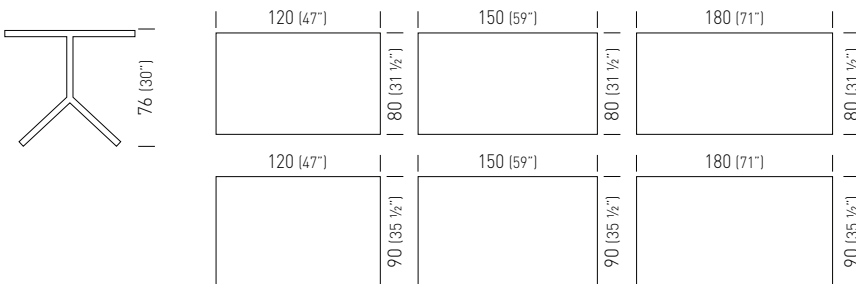
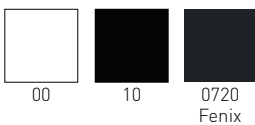

80x120laminated	TFLPL460.___-_/H76	0.6m ³ / 27kg / 1pcs	DKK - kr	5.895
80x120lam.fenix	TFLPL460.0720-_/H76	0.6m ³ / 27kg / 1pcs		6.195
80x150laminated	TFLPL461.___-_/H76	0.7m ³ / 30kg / 1pcs		7.295
80x150lam.fenix	TFLPL461.0720-_/H76	0.7m ³ / 30kg / 1pcs		7.495
80x180laminated	TFLPL462.___-_/H76	0.8m ³ / 33kg / 1pcs		7.895
80x180lam.fenix	TFLPL462.0720-_/H76	0.8m ³ / 33kg / 1pcs		8.295
90x120laminated	TFLPL463.___-_/H76	0.6m ³ / 30kg / 1pcs		6.095
90x120lam.fenix	TFLPL463.0720-_/H76	0.6m ³ / 30kg / 1pcs		6.395
90x150laminated	TFLPL464.___-_/H76	0.7m ³ / 33kg / 1pcs		7.495
90x150lam.fenix	TFLPL464.0720-_/H76	0.7m ³ / 33kg / 1pcs		7.795
90x180laminated	TFLPL465.___-_/H76	0.8m ³ / 36kg / 1pcs		8.195
90x180lam.fenix	TFLPL465.0720-_/H76	0.8m ³ / 36kg / 1pcs		8.495

Format

Studio Eurolinea Design

Table with metal painted frame and Compactop table top.
Suitable for outdoor purpose. Adjustable feet.
Tavolo con struttura in metallo verniciato, piano in Compactop.
Adatto anche all'uso esterno. Piedini regolabili.



Frame Color / Colore Struttura

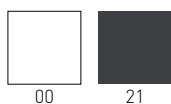

Compactop Color / Colore Piano Compactop

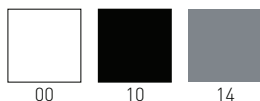

Special Finishes / Finiture Speciali

Compactop: Special Compactop Surfaces Fullcolor (p. 377) available on demand (min. 5pcs each code).
Special Compactop Surfaces Fullcolor (p. 377) disponibile su richiesta (min. 5pcs per codice).
Special Compactop Surfaces 10 (p. 378) available on demand (min. 20pcs each code).
Special Compactop Surfaces 10 (p. 378) disponibile su richiesta (min. 20pcs per codice).

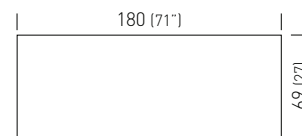
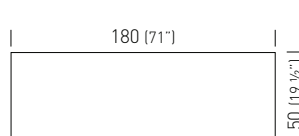
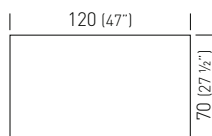
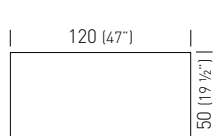
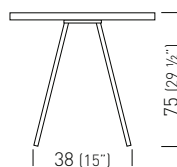

120x50
120x70
180x50
180x69

TFORC840.___/_/H75
TFORC842.___/_/H75
TFORC844.___/_/H75
TFORC846.___/_/H75

0.47m³ / 23kg / 1pcs
 0.48m³ / 24kg / 1pcs
 0.80m³ / 25kg / 1pcs
 0.80m³ / 26kg / 1pcs

DKK - kr

5.195
5.295
6.395
6.595

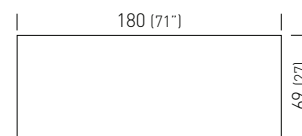
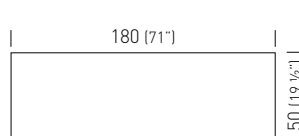
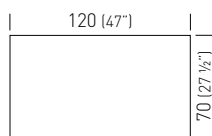
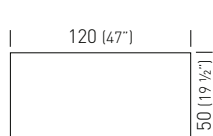
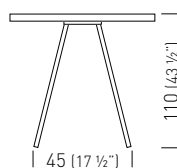

120x50
120x70
180x50
180x69

TFORC840.___/_/H110
TFORC842.___/_/H110
TFORC844.___/_/H110
TFORC846.___/_/H110

0.47m³ / 25kg / 1pcs
 0.48m³ / 26kg / 1pcs
 0.80m³ / 27kg / 1pcs
 0.80m³ / 28kg / 1pcs

5.295
5.395
6.495
6.695

Glitter

Forsix Design



Only Compactop
Solo piani Compactop

The Glitter table oozes simplicity and practicality. The sturdy steel structure with its three support points is also available at poseur height and features essential minimalist design, in order to fit in discreetly to any environment. Base are in epoxy powder coated steel with outdoor treatment, table tops are available in Compactop or Laminated.

Il tavolo Glitter esprime semplicità e praticità. La stabile struttura in acciaio a tre punti di appoggio, disponibile anche nell'altezza snack, è caratterizzata da un design essenziale e minimale, per potersi relazionare con discrezione agli ambienti di utilizzo. Le basi sono realizzate in acciaio verniciato a polveri epossidiche con trattamento per esterno, i piani possono essere realizzati in Compactop o Laminato.

Frame Color / Colore Struttura

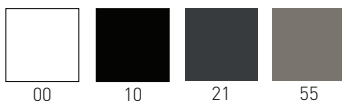

Compactop Color / Colore Piano Compactop

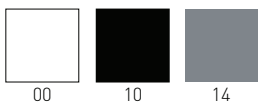

Laminated Top Color / Colore Piano Laminato



Special Finishes / Finiture Speciali

Compactop: Special Compactop Surfaces Fullcolor (p. 377) available on demand (min. 5pcs each code).
Special Compactop Surfaces Fullcolor (p. 377) disponibile su richiesta (min. 5pcs per codice).
Special Compactop Surfaces Fenix (p. 380) available on demand (min. 20pcs each code).
Special Compactop Surfaces Fenix (p. 380) disponibile su richiesta (min. 20pcs per codice).
Special Compactop Surfaces 10 (p. 378) available on demand (min. 20pcs each code).
Special Compactop Surfaces 10 (p. 378) disponibile su richiesta (min. 20pcs per codice).

Laminated: Special Laminated Surfaces Wood Effect (p. 383) available on demand (min. 20pcs each code).
Special Laminated Surfaces Wood Effect (p. 383) disponibile su richiesta (min. 20pcs per codice).
Special Laminated Surfaces Fenix (p. 384) available on demand (min. 20pcs each code).
Special Laminated Surfaces Fenix (p. 384) disponibile su richiesta (min. 20pcs per codice).

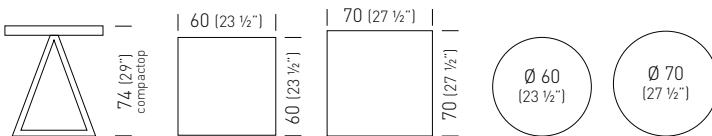

60x60 laminated	TGLTL557. __-__ /H74		0.23m ³ / 12.4kg / 1pc	DKK - kr	2.495
70x70 laminated	TGLTL559. __-__ /H74		0.25m ³ / 15.4kg / 1pc		2.595
diam.60 laminated	TGLTL556. __-__ /H74		0.23m ³ / 11.4kg / 1pc		2.495
diam.70 laminated	TGLTL558. __-__ /H74		0.25m ³ / 12.4kg / 1pc		2.795
60x60 compactop	TGLTC543. __-__ /H74		0.23m ³ / 11.9kg / 1pc		2.895
70x70 compactop	TGLTC549. __-__ /H74		0.25m ³ / 15.4kg / 1pc		3.095
diam.60 compactop	TGLTC540. __-__ /H74		0.23m ³ / 11.4kg / 1pc		3.195
diam.70 compactop	TGLTC546. __-__ /H74		0.25m ³ / 12.4kg / 1pc		3.495

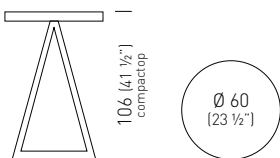

diam.60 laminated	TGLTL556. __-__ /H105		0.25m ³ / 12.05kg / 1pc	2.895
diam.60 compactop	TGLTC540. __-__ /H105		0.25m ³ / 12.05kg / 1pc	3.495

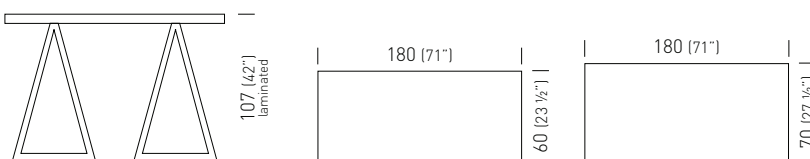

60x180 laminated	TGLTL561. __-__ /2H105		0.39m ³ / 27.5kg / 1pc	5.995
70x180 laminated	TGLTL562. __-__ /2H105		0.39m ³ / 29.9kg / 1pc	6.195

Hug

Studio Eurolinea Design

The Hug collection is characterized by the possibility of combine table tops in Compactop or Steel, which can also be used outdoors, or in Laminate, for the most specific indoor settings. The table is made with a 4-star aluminum base, equipped with adjustable feet, and aluminum column and cross.

La collezione Hug è caratterizzata dalla possibilità di poter abbinare piani tavoli in Compactop e Steel, utilizzabili anche all'esterno, o in Laminato per le più specifiche ambientazioni indoor. Il tavolo è realizzato con basamento 4 razze in alluminio, dotato di piedini regolabili, e da colonna e crociera in alluminio.



Only Steel and Compactop
Solo piani Acciaio e Compactop



Frame Color / Colore Struttura

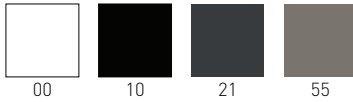

Compactop Color / Colore Piano Compactop

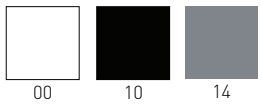

Laminated Top Color / Colore Piano Laminato



Special Finishes / Finiture Speciali

Compactop: Special Compactop Surfaces Fullcolor (p. 377) available on demand (min. 5pcs each code).
Special Compactop Surfaces Fullcolor (p. 377) disponibile su richiesta (min. 5pcs per codice).
Special Compactop Surfaces Fenix (p. 380) available on demand (min. 20pcs each code).
Special Compactop Surfaces Fenix (p. 380) disponibile su richiesta (min. 20pcs per codice).
Special Compactop Surfaces 10 (p. 378) available on demand (min. 20pcs each code).
Special Compactop Surfaces 10 (p. 378) disponibile su richiesta (min. 20pcs per codice).

Laminated: Special Laminated Surfaces Wood Effect (p. 383) available on demand (min. 20pcs each code).
Special laminated Surfaces Wood Effect (p. 383) disponibile su richiesta (min. 20pcs per codice).
Special Laminated Surfaces Fenix (p. 384) available on demand (min. 20pcs each code).
Special laminated Surfaces Fenix (p. 384) disponibile su richiesta (min. 20pcs per codice).

Steel Top Color / Colore Piano Acciaio

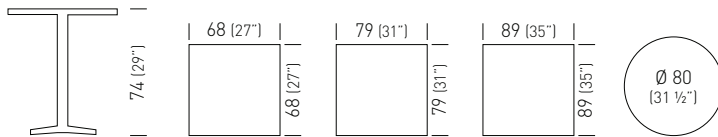
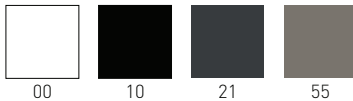

68x68compactop	THUGC200.__-__ /H74		0.17m³ / 15.1kg / 1pc	DKK - kr	2.995
79x79compactop	THUGC204.__-__ /H74		0.18m³ / 15.6kg / 1pc		3.195
89x89compactop	THUGC212.__-__ /H74		0.20m³ / 18.1kg / 1pc		3.695
diam.80compactop	THUGC208.__-__ /H74		0.18m³ / 15.1kg / 1pc		3.495

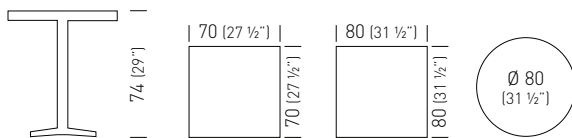

70x70 steel	THUGI217.__-__ /H74		0.17m³ / 15.0kg / 1pc		3.095
80x80 steel	THUGI218.__-__ /H74		0.18m³ / 16.0kg / 1pc		3.295
diam.80 steel	THUGI219.__-__ /H74		0.18m³ / 13.0kg / 1pc		3.695

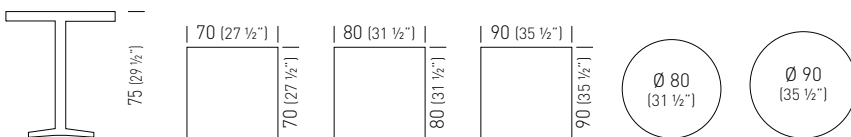

70x70laminated	THUGL220.__-__ /H75		0.17m³ / 15.1kg / 1pc		2.695
80x80laminated	THUGL222.__-__ /H75		0.18m³ / 17.6kg / 1pc		2.795
90x90laminated	THUGL224.__-__ /H75		0.20m³ / 19.1kg / 1pc		3.095
diam.80laminated	THUGL221.__-__ /H75		0.18m³ / 12.6kg / 1pc		3.295
diam.90laminated	THUGL223.__-__ /H75		0.20m³ / 13.6kg / 1pc		3.595

Hug Marble

Studio Eurolinea Design



The Hug tables collection, made with a 4-star aluminum base, equipped with adjustable feet, is enriched with new Marble tops, thus adapting to the most prestigious installations. The Marble tops, characterized by always different veins of natural stones, contribute to enhance elegance and refinement for the most demanding environments.

The solid Marble surfaces, shiny and glossy, are treated to reduce their porosity, however constant care and cleaning of the product is recommended.

La collezione di tavoli Hug, realizzata con basamento 4 raze in alluminio, dotata di piedini regolabili, si arricchisce di nuovi piani quadrati in Marmo, adattandosi così alle installazioni più prestigiose. I piani in Marmo, caratterizzati dalle sempre diverse venature della pietra naturale, offrono eleganza e raffinatezza, per completare con esclusività gli ambienti più ricercati. I solidi piani in Marmo, splendenti e lucidi, sono trattati per ridurre la porosità, tuttavia si consiglia pulizia costante e cura nell'utilizzo del prodotto.

Frame Color / Colore Struttura

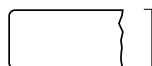
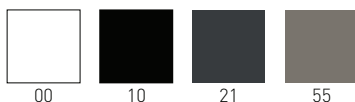

20 mm
(0.78")
DOUBLE-RADIUS STRAIGHT-EDGE
COSTA RETTA BISELLATA

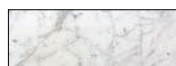

MBC
BIANCO CARRARA



MNM
NERO MARQUINA



MVG
VERDE GUATEMALA



MED
EMPERADOR DARK

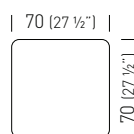
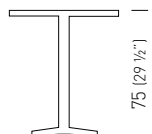

70x70

THUGM215._-_/H74



0.34m³ / 31.1kg / 1pc

DKK - kr

5.895

Hug Porcelain

Studio Eurolinea Design

The Hug tables collection, made with a 4-star aluminum base, equipped with adjustable feet, is enriched with new Porcelain tops, thus adapting to the most prestigious installations. The Porcelain stoneware tops stand out for their excellent technical performance, ideal for the most delicate uses where maximum hygiene and resistance must be guaranteed. Porcelain tops are compatible with foodstuffs, resistant to fungi and molds, suitable for both indoor and outdoor use, resistant to frost, heat and high temperatures, they can be cleaned very easily while maintaining the characteristics of the surface.

La collezione di tavoli Hug, realizzata con basamento 4 razze in alluminio, dotata di piedini regolabili, si arricchisce di nuovi piani quadrati in Gres Porcellanato, adattandosi così alle installazioni più prestigiose. I piani in Gres Porcellanato si distinguono per le eccellenti performance tecniche, ideali negli impieghi più delicati nei quali è necessario garantire la massima igiene e resistenza. I piani Porcelain sono compatibili con le sostanze alimentari, resistenti a funghi e muffe, idonei ad un utilizzo sia interno che esterno, resistenti al gelo, al calore a alle alte temperature, si possono pulire con estrema facilità mantenendo inalterate le caratteristiche della superficie.



Frame Color / Colore Struttura

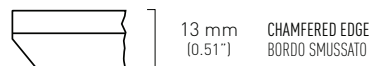
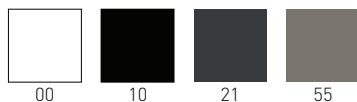

13 mm
(0.51") CHAMFERED EDGE
BORDO SMUSSATO



PCO
CALACATTA ORO



PNG
NERO GRECO

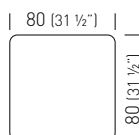
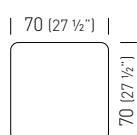
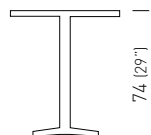

70x70
80x80

THUGP226._____/H74
THUGP227._____/H74



2.4m³ / 32.6kg / 1pc
2.4m³ / 39.1kg / 1pc

DKK - kr

13.695
13.895

Min. order 10pcs
each code
Ordine min 10pz
per codice



Frame Color / Colore Struttura

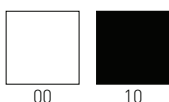

Compactop Color / Colore Piano Compactop



Laminated Top Color / Colore Piano Laminato



Special Finishes / Finiture Speciali

Compactop: Special Compactop Surfaces Fullcolor (p. 377) available on demand (min. 5pcs each code).
Special Compactop Surfaces Fullcolor (p. 377) disponibile su richiesta (min. 5pcs per codice).
Special Compactop Surfaces 10 (p. 378) available on demand (min. 20pcs each code).
Special Compactop Surfaces 10 (p. 378) disponibile su richiesta (min. 20pcs per codice).

Laminated: Special Laminated Surfaces Wood Effect 25 (p. 383) available on demand (min. 20pcs each code).
Special Laminated Surfaces Wood Effect 25 (p. 383) disponibile su richiesta (min. 20pcs per codice).
Special Laminated Surfaces Fenix 25 (p. 384) available on demand (min. 20pcs each code).
Special Laminated Surfaces Fenix 25 (p. 384) disponibile su richiesta (min. 20pcs per codice).

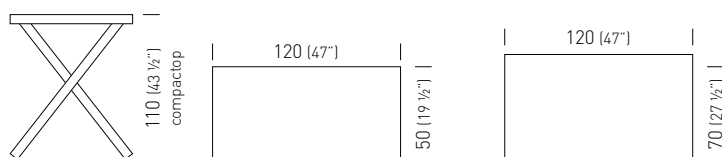

120x50compactop
120x50laminated
120x70compactop
120x70laminated

TICSC830._._/H110
TICSL836._._/H110
TICSC832._._/H110
TICSL838._._/H110

0.47m³ / 25kg / 1pcs
 0.47m³ / 25kg / 1pcs
 0.48m³ / 26kg / 1pcs
 0.48m³ / 26kg / 1pcs

DKK - kr

5.595
4.695
5.795
5.295

Link

Stefano Sandonà Design

Waiting areas and Coffee Table,
painted metal structure suitable
for outdoor purpose.

Tavolino attesa, struttura in metallo
verniciato per utilizzo esterno.



Frame Color / Colore Struttura

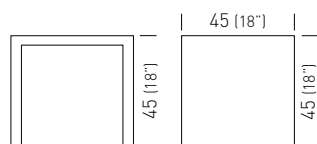
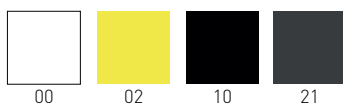

45x45

TLNKI025_/_/H45



0.18m³ / 7kg / 1pcs

DKK - kr

1.695

Login

Studio Eurolinea Design



Table with co-injected metal frame with techno polymer, wooden legs, Laminated Top.
Tavolo con struttura in metallo sovrastampato con tecnopolimero, gambe in legno massello di faggio o rovere, piani in Laminato.

Frame Color / Colore Struttura

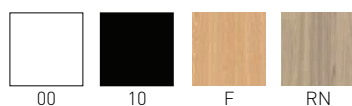

Laminated Top Color / Colore Piano Laminato



Special Finishes / Finiture Speciali

Laminated: Special Laminated Surfaces Wood Effect 25 (p. 383) available on demand (min. 20pcs each code)
Special Laminated Surfaces Wood Effect 25 (p. 383) disponibile su richiesta (min. 20pcs per codice)
Special Laminated Surfaces Fenix 25 (p. 384) available on demand (min. 20pcs each code)
Special Laminated Surfaces Fenix 25 (p. 384) disponibile su richiesta (min. 20pcs per codice)

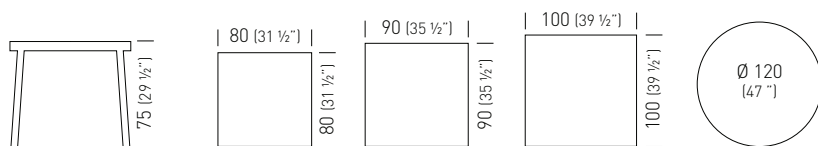

80x80laminated
90x90laminated
100x100laminated
diam. 120laminated

TLOGL230.___/_/H75  0.35m³ / 21kg / 1pcs
TLOGL232.___/_/H75  0.46m³ / 22kg / 1pcs
TLOGL234.___/_/H75  0.46m³ / 24kg / 1pcs
TLOGL236.___/_/H75  0.80m³ / 26kg / 1pcs

DKK - kr

4.495
4.995
5.295
7.095

Lol

Forsix Design

The "Lol" table collection is intended for outdoor use; youthfully simple and sunny, its design blends in discreetly with either the most sparkling or the most sober environments. The table tops with composite material core, as well as the bases, available with three or four spokes, are made up of a metal structure treated for outdoor use, and with a matt finish. The available colour palette is common to many Gaber seating collections, guaranteeing tone-on-tone colour co-ordination throughout designed settings rather than lively contrasts, defining various colour combinations between bases, tops and seating.

La collezione di tavoli Lol, disegnata da Forsix, è ideale per l'utilizzo all'aria aperta: giovane, semplice e solare, il suo design si fonde con discrezione dagli ambienti più sobri a quelli più frizzanti. I piani del tavolo, dal cuore in materiale composito, come anche i basamenti, disponibili a tre o quattro razze, sono costituiti da una struttura in metallo trattata per esterni, dalla finitura opaca. La palette di colori disponibile è comune a molte collezioni di sedute Gaber, garantendo abbinamenti tono su tono degli ambienti progettati, piuttosto che vivaci contrasti, definendo diverse combinazioni di colori tra basi, piani e sedute.



Colors / Colori

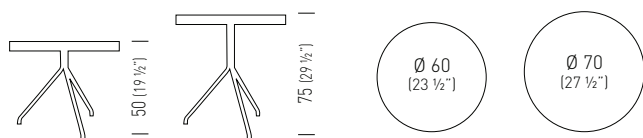
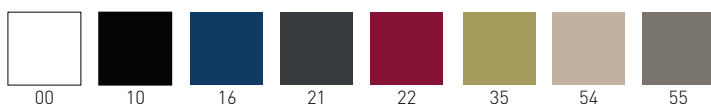

diam.60	TLL31034._._/H50	0.19m³ / 10.30kg / 1pc	DKK - kr	2.595
diam.70	TLL31036._._/H50	0.19m³ / 10.70kg / 1pc		2.595
diam.60	TLL31034._._/H75	0.26m³ / 10.90kg / 1pc		2.795
diam.70	TLL31036._._/H75	0.26m³ / 11.30kg / 1pc		2.895

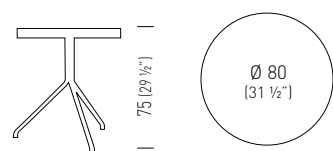

diam.80	TLL31038._._/H75	0.45m³ / 12.00kg / 1pc	3.595
---------	------------------	------------------------	--------------

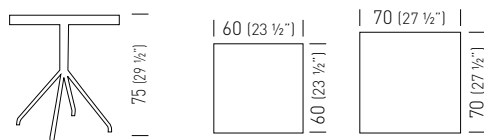

60x60	TLL41035._._/H75	0.26m³ / 13.00kg / 1pc	2.795
70x70	TLL41037._._/H75	0.26m³ / 14.60kg / 1pc	2.895

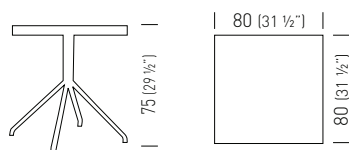

80x80	TLL41039._._/H75	0.38m³ / 16.30kg / 1pc	3.395
-------	------------------	------------------------	--------------

Lol Plus

Forsix Design



The Lol Plus tables collection is made of steel, the cross is made in aluminum, and provided with flip-top joint. The shape of the base and the flip-top mechanism allow the table to easily fold and stack, space-saving. The available colour palette is common to many Gaber seating collections, guaranteeing tone-on-tone colour co-ordination throughout designed settings rather than lively contrasts, defining various colour combinations between bases, tops and seating.

La Collezione di tavoli Lol Plus è realizzata in acciaio, la crociera è realizzata in alluminio, ed è dotata di giunto per la rotazione del piano. La forma della base e la meccanica che permette la rotazione del piano in posizione verticale, rendono il tavolo facilmente accatastabile in spazi ridotti. La palette di colori disponibile è comune a molte collezioni di sedute Gaber, garantendo abbinamenti tono su tono degli ambienti progettati, piuttosto che vivaci contrasti, definendo diverse combinazioni di colori tra basi, piani e sedute.

Frame Color / Colore Struttura

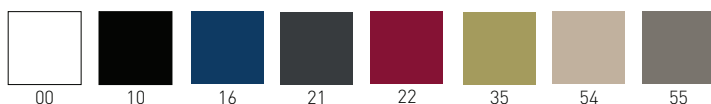

diam.60

TLLPI034._._/H75



0.26m³ / 12.10kg / 1pc

DKK - kr

2.995

60x60

TLLPI035._._/H75



0.26m³ / 13.50kg / 1pc

3.095

Lol Marble

Forsix Design

The Lol tables collection is enriched with new Marble tops, with round or square shapes, thus adapting to the most prestigious installations. The Marble tops, characterized by always different veins of natural stones, contribute to enhance elegance and refinement for the most demanding environments. The solid Marble surfaces, shiny and glossy, are treated to reduce their porosity, however constant care and cleaning of the product is recommended. La collezione di tavoli Lol si arricchisce di nuovi piani in Marmo, dalle forme rotonde o quadrate, adattandosi così alle più prestigiose installazioni. I piani in Marmo, caratterizzati dalle sempre diverse venature della pietra naturale, offrono eleganza e raffinatezza, per completare con esclusività gli ambienti più ricercati. I solidi piani in Marmo, splendenti e lucidi, sono trattati per ridurre la porosità, tuttavia si consiglia pulizia costante e cura nell'utilizzo del prodotto.



Frame Color / Colore Struttura

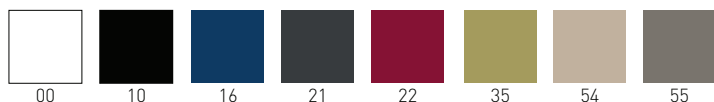

20 mm
(0.78")
DOUBLE-RADIUS STRAIGHT-EDGE
COSTA RETTA BISELLATA



MBC
BIANCO CARRARA



MNM
NERO MARQUINA



MVG
VERDE GUATEMALA

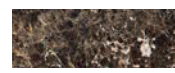

MED
EMPERADOR DARK



diam.60
diam.70

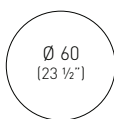

Ø 60
(23 1/2")

TLL3M238._._/H50
TLL3M240._._/H50

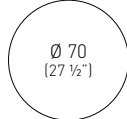

Ø 70
(27 1/2")

0.37m³ / 20kg / 1pc
 0.37m³ / 25kg / 1pc

DKK - kr

4.695
5.395

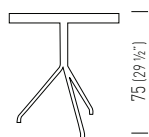

diam.60
diam.70
diam.80

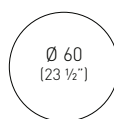

Ø 60
(23 1/2")

TLL3M238._._/H75
TLL3M240._._/H75
TLL3M242._._/H75

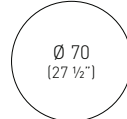

Ø 70
(27 1/2")

0.44m³ / 20.6kg / 1pc
 0.44m³ / 25.6kg / 1pc
 0.63m³ / 31.7kg / 1pc

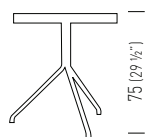

Ø 80
(31 1/2")

4.995
5.695
7.095

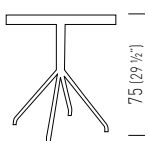

60x60
70x70

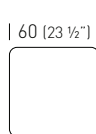

TLL4M239._._/H75
TLL4M241._._/H75

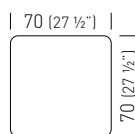

0.44m³ / 25.5kg / 1pc
 0.44m³ / 32kg / 1pc

4.995
5.695

Lol Porcelain

Forsix Design



The Lol tables collection is enriched with new Porcelain tops, with round or square shapes, thus adapting to the most prestigious installations. The Porcelain stoneware tops stand out for their excellent technical performance, ideal for the most delicate uses where maximum hygiene and resistance must be guaranteed. Porcelain tops are compatible with foodstuffs, resistant to fungi and molds, suitable for both indoor and outdoor use, resistant to frost, heat and high temperatures, they can be cleaned very easily while maintaining the characteristics of the surface.

La collezione di tavoli Lol si arricchisce di nuovi piani in Gres Porcellanato, dalle forme rotonde o quadrate, adattandosi così alle più prestigiose installazioni. I piani in Gres Porcellanato si distinguono per le eccellenti performance tecniche, ideali negli impieghi più delicati nei quali è necessario garantire la massima igiene e resistenza.

I piani Porcelain sono compatibili con le sostanze alimentari, resistenti a funghi e muffe, idonei ad un utilizzo sia interno che esterno, resistenti al gelo, al calore a alle alte temperature, si possono pulire con estrema facilità mantenendo inalterate le caratteristiche della superficie.

Frame Color / Colore Struttura

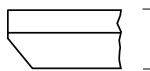
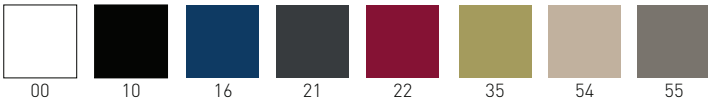

13 mm
(0.51")
CHAMFERED EDGE
BORDO SMUSSATO



PCO
CALACATTA ORO



PNG
NERO GRECO

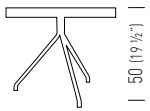

diam.60
diam.70

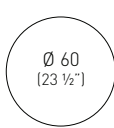

Ø 60
(23 1/2")

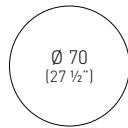

Ø 70
(27 1/2")

TLL3P244._._/H50
TLL3P246._._/H50

0.87m³ / 23.8kg / 1pc
 0.87m³ / 27kg / 1pc

DKK - kr

7.195
8.095

Min. order 10pcs
each code
Ordine min 10pz
per codice

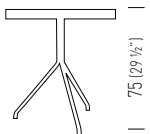

diam.60
diam.70
diam.80

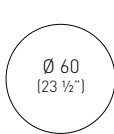

Ø 60
(23 1/2")

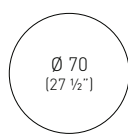

Ø 70
(27 1/2")

TLL3P244._._/H75
TLL3P246._._/H75
TLL3P248._._/H75

0.94m³ / 24.4kg / 1pc
 0.94m³ / 27.6kg / 1pc
 1.13m³ / 32.2kg / 1pc

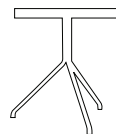

75 (29 1/2")

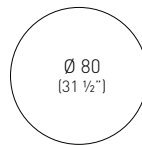

Ø 80
(31 1/2")

7.495
8.295
9.795

Min. order 10pcs
each code
Ordine min 10pz
per codice

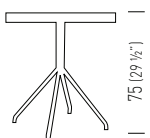

60x60
70x70
80x80

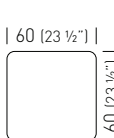

60 (23 1/2")
60 (23 1/2")

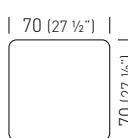

70 (27 1/2")
70 (27 1/2")

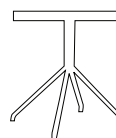

75 (29 1/2")

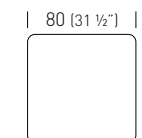

80 (31 1/2")
80 (31 1/2")

TLL4P245._._/H75
TLL4P247._._/H75
TLL4P249._._/H75

0.94m³ / 28.5kg / 1pc
 0.94m³ / 31.5kg / 1pc
 1.05m³ / 29.1kg / 1pc

6.995
8.395
8.895

Min. order 10pcs
each code
Ordine min 10pz
per codice

Minush

Studio Eurolinea Design

The Minush stackable coffee table, made of technopolymer, takes up the lines of some collections of Gaber chairs and sunbeds, but suit perfectly any outdoor seat as a practical support for small objects.

Il tavolino impilabile Minush, realizzato in tecnopolimero, riprende le linee di alcune collezioni di sedute e lettini Gaber, ma ben si adatta ad accompagnare qualunque seduta da esterno come pratico appoggio per piccoli oggetti.



Technopolymer Frame Color / Colore Struttura Tecnopolimero

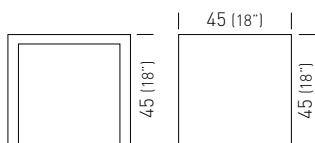
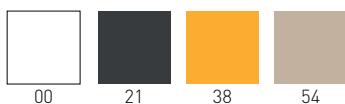

45x45

TMINT024.../H45

 0.13m³ / 8kg / 2pcs

DKK - kr

995

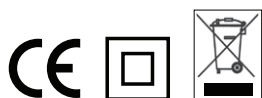

230V - 50Hz
1 X 16W - Led Modul
IP 65

H75 Table with Compactop, Technopolymer base.
Available illuminated and suitable for outdoor use.
Tavolo realizzato con piano in Compactop H75
e struttura in tecnopolimero.
Disponibile con versione luminosa
e adatti all'uso esterno.

Technopolymer Base Color / Colore Base Tecnopolimero



Led version with white transparent base.
Versione led con base in bianco trasparente.

Compactop Color / Colore Piano Compactop

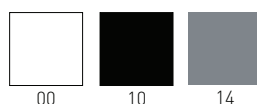

Special Finishes / Finiture Speciali

Compactop: Special Compactop Surfaces Fullcolor (p.377) white available on demand (min. 5pcs each code).
Special Compactop Surfaces Fullcolor (p.377) bianco disponibile su richiesta (min. 5pcs per codice).

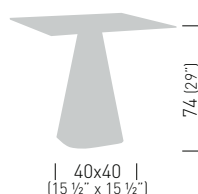

base74
base74 Led
base74+20

diam.60
diam.60 Led
diam.60+20

diam.68
diam.68 Led
diam.68+20

diam.80
diam.80 Led
diam.80+20

diam.100
diam.100 Led
diam.100+20

60 (23 1/2")



60x60
60x60 Led
60x60+20

68 (27")



68x68
68x68 Led
68x68+20

79 (31")



79x79
79x79 Led
79x79+20

89 (35")



89x89
89x89 Led
89x89+20

BMUG.__/H74 0.13m³ / 12.5kg / 1pcs
BMUG.__/H74L 0.13m³ / 14.7kg / 1pcs
BMUG.__/H74+20 0.13m³ / 32.5kg / 1pcs

TMUGC170.___/H74 0.21m³ / 18.0kg / 1pcs
TMUGC170.___/H74L 0.21m³ / 20.2kg / 1pcs
TMUGC170.___/H74+20 0.21m³ / 38.0kg / 1pcs

TMUGC178.___/H74 0.23m³ / 21.5kg / 1pcs
TMUGC178.___/H74L 0.23m³ / 23.7kg / 1pcs
TMUGC178.___/H74+20 0.23m³ / 41.5kg / 1pcs

TMUGC186.___/H74 0.5m³ / 23.5kg / 1pcs
TMUGC186.___/H74L 0.5m³ / 25.7kg / 1pcs
TMUGC186.___/H74+20 0.5m³ / 43.5kg / 1pcs

TMUGC198.___/H74 0.67m³ / 28.0kg / 1pcs
TMUGC198.___/H74L 0.67m³ / 32.2kg / 1pcs
TMUGC198.___/H74+20 0.67m³ / 48.0kg / 1pcs

TMUGC174.___/H74 0.21m³ / 20.0kg / 1pcs
TMUGC174.___/H74L 0.21m³ / 22.5kg / 1pcs
TMUGC174.___/H74+20 0.21m³ / 39.5kg / 1pcs

TMUGC182.___/H74 0.23m³ / 21.8kg / 1pcs
TMUGC182.___/H74L 0.23m³ / 24.0kg / 1pcs
TMUGC182.___/H74+20 0.23m³ / 41.8kg / 1pcs

TMUGC190.___/H74 0.50m³ / 25.0kg / 1pcs
TMUGC190.___/H74L 0.50m³ / 27.0kg / 1pcs
TMUGC190.___/H74+20 0.50m³ / 45.0kg / 1pcs

TMUGC194.___/H74 0.60m³ / 26.0kg / 1pcs
TMUGC194.___/H74L 0.60m³ / 28.0kg / 1pcs
TMUGC194.___/H74+20 0.60m³ / 46.0kg / 1pcs

DKK - kr **1.395**

3.495

1.595

2.895

4.895

3.095

3.195

5.195

3.395

4.295

6.295

4.495

5.695

7.395

5.895

2.595

4.695

2.895

2.795

4.895

3.095

3.895

5.895

4.095

4.895

6.695

5.095

Norman

Forsix Design

The Norman table collection is made using basic geometries to achieve distinctly shapes. Available with round or square Laminated, Compactop or Marble tops, Norman utilizes a 4 legged aluminum frame, available in many vibrant colours.

La collezione di Tavoli Norman è realizzata utilizzando geometrie semplici e forme essenziali. Disponibile con piani rotondi o quadrati in Laminato, Compactop o Marmo, Norman utilizza una struttura 4 gambe in alluminio, disponibile in vari colori di tendenza.



Only for Compactop and Steel tops
Solo per piani in compactop e acciaio



Frame Color / Colore Struttura



Compactop Color / Colore Piano Compactop

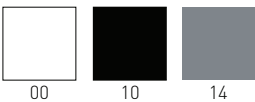

Laminated Top Color / Colore Piano Laminato



Steel Top Color / Colori Top Steel

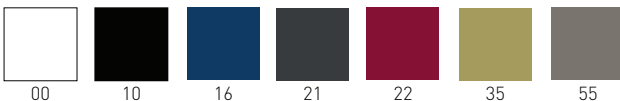

Special Finishes / Finiture Speciali

Compactop: Standard Compactop Surfaces 10 (p. 376) available on demand (min. 20pcs each code)
Standard Compactop Surfaces 10 (p. 376) disponibile su richiesta (min. 20pcs per codice)
Special Compactop Surfaces Fullcolor (p.377) white available on demand (min. 5pcs each code).
Special Compactop Surfaces Fullcolor (p.377) bianco disponibile su richiesta (min. 5pcs per codice).

Laminated: Special Laminated Surfaces Wood Effect 25 (p. 383) available on demand (min. 20pcs each code)
Special Laminated Surfaces Wood Effect 25 (p. 383) disponibile su richiesta (min. 20pcs per codice)
Special Laminated Surfaces Fenix 25 (p. 384) available on demand (min. 20pcs each code)
Special Laminated Surfaces Fenix 25 (p. 384) disponibile su richiesta (min. 20pcs per codice)

Laminated / Laminato

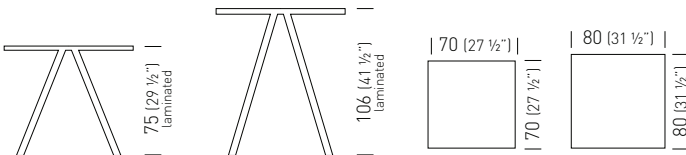

70x70	TNORL481. __-__ /H74		0.20m ³ / 16.20kg / 1pc	DKK - kr	2.395
80x80	TNORL483. __-__ /H74		0.22m ³ / 18.70kg / 1pc		
diam.70	TNORL480. __-__ /H74		0.20m ³ / 13.20kg / 1pc		2.695
diam.80	TNORL482. __-__ /H74		0.22m ³ / 16.70kg / 1pc		3.395
70x70	TNORL481. __-__ /H105		0.20m ³ / 17.34kg / 1pc		2.595
80x80	TNORL483. __-__ /H105		0.22m ³ / 19.84kg / 1pc		2.995
diam.70	TNORL480. __-__ /H105		0.20m ³ / 14.34kg / 1pc		2.895
diam.80	TNORL482. __-__ /H105		0.22m ³ / 17.84kg / 1pc		3.495



Only for Compact and Steel tops
Solo per piani in compact e acciaio

Frame Color / Colore Struttura



Compact Color / Colore Piano Compact

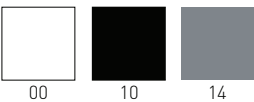

Laminated Top Color / Colore Piano Laminato



Special Finishes / Finiture Speciali

Compact: Standard Compactop Surfaces 10 (p. 376) available on demand (min. 20pcs each code)
Standard Compactop Surfaces 10 (p. 376) disponibile su richiesta (min. 20pcs per codice)
Special Compactop Surfaces Fullcolor (p.377) white available on demand (min. 5pcs each code).
Special Compactop Surfaces Fullcolor (p.377) bianco disponibile su richiesta (min. 5pcs per codice).

Laminated: Special Laminated Surfaces Wood Effect 25 (p. 383) available on demand (min. 20pcs each code)
Special Laminated Surfaces Wood Effect 25 (p. 383) disponibile su richiesta (min. 20pcs per codice)
Special Laminated Surfaces Fenix 25 (p. 384) available on demand (min. 20pcs each code)
Special Laminated Surfaces Fenix 25 (p. 384) disponibile su richiesta (min. 20pcs per codice)

Steel Top Color / Colori Top Steel



Compactop / Compactop

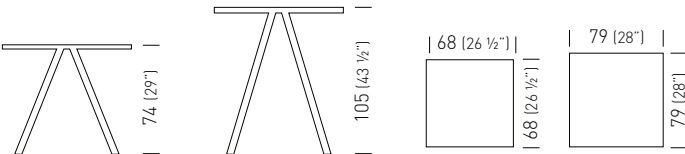

68x68
79x79
diam.68
diam.80

TNORC472._._/H74
TNORC476._._/H74
TNORC470._._/H74
TNORC474._._/H74

0.20m³ / 16.20kg / 1pc
 0.22m³ / 16.70kg / 1pc
 0.20m³ / 13.20kg / 1pc
 0.22m³ / 16.30kg / 1pc

DKK - kr

2.795
2.995
2.995
3.395

68x68
79x79
diam.68
diam.80

TNORC472._._/H105
TNORC476._._/H105
TNORC470._._/H105
TNORC474._._/H105

0.20m³ / 17.34kg / 1pc
 0.22m³ / 17.84kg / 1pc
 0.20m³ / 14.34kg / 1pc
 0.22m³ / 17.44kg / 1pc

2.995
3.195
3.195
3.595

Steel / Acciaio

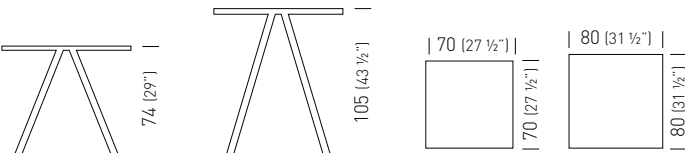

70x70
80x80
diam.70
diam.80

TNORI486._._/H74
TNORI488._._/H74
TNORI485._._/H74
TNORI487._._/H74

0.20m³ / 19.20kg / 1pc
 0.22m³ / 20.20kg / 1pc
 0.20m³ / 16.20kg / 1pc
 0.22m³ / 21.20kg / 1pc

2.995
3.695
2.995
3.695

70x70
80x80
diam.70
diam.80

TNORI486._._/H105
TNORI488._._/H105
TNORI485._._/H105
TNORI487._._/H105

0.20m³ / 20.34kg / 1pc
 0.22m³ / 21.34kg / 1pc
 0.20m³ / 17.34kg / 1pc
 0.22m³ / 22.34kg / 1pc

3.195
3.895
3.195
3.895

Norman Marble

Forsix Design

The Norman table collection utilizes a 4 legged aluminum frame, available in many vibrant colours. The Marble tops, characterized by always different veins of natural stones, contribute to enhance elegance and refinement for the most demanding environments. The solid Marble surfaces, shiny and glossy, are treated to reduce their porosity, however constant care and cleaning of the product is recommended.

La collezione di Tavoli Norman utilizza una struttura 4 gambe in alluminio, disponibile in vari colori di tendenza. I piani in Marmo, caratterizzati dalle sempre diverse venature della pietra naturale, offrono eleganza e raffinatezza, per completare con esclusività gli ambienti più ricercati.

I solidi piani in Marmo, splendenti e lucidi, sono trattati per ridurre la porosità, tuttavia si consiglia pulizia costante e cura nell'utilizzo del prodotto.



Frame Color / Colore Struttura

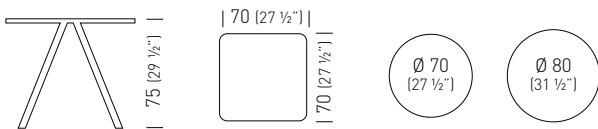
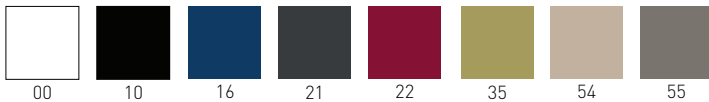

70x70	TNORM491.____/H75		0.34m³ / 30.20kg / 1pc	DKK - kr	5.095
diam.70	TNORM490.____/H75		0.34m³ / 24.70kg / 1pc		5.095
diam.80	TNORM492.____/H75		0.34m³ / 30.70kg / 1pc		5.695

Pareo

Forsix Design



Only for compactop
solo per compactop

The Pareo Collection offers a wide range of beautifully designed dining and coffee tables. Thanks to their clean yet detailed design, Pareo tables suit a variety of hospitality settings, available in square, rectangular and round versions. The aluminum table frame, combined with Compact or Porcelain table tops, fits perfectly into even outdoor environments. Pareo Tables are made to be easily assembled and are available in a wide variety of bright frame colours and top finishes, perfectly matching your custom projects.

La collezione Pareo offre una vasta gamma di tavoli e tavolini dal design accattivante. Grazie alle loro linee essenziali e curate, i tavoli Pareo si adattano a diversi stili dedicati all'ospitalità e sono disponibili nella versione quadrata, rettangolare o rotonda. La struttura del tavolo, realizzata in alluminio, abbinata ai piani in Compactop o Gres, si adatta perfettamente anche agli ambienti esterni. I tavoli Pareo sono realizzati per essere facilmente e velocemente assemblati e sono disponibili in un'ampia varietà di colori e finiture, perfetti per i vostri progetti personalizzati.

Frame Color / Colore Struttura

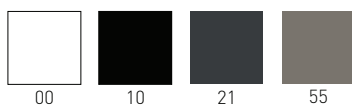

Compactop Color / Colore Piano Compactop

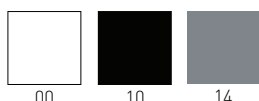

Special Finishes / Finiture Speciali

Compactop: Special Compactop Surfaces Fullcolor (p. 377) available on demand (min. 5pcs each code).
Special Compactop Surfaces Fullcolor (p. 377) disponibile su richiesta (min. 5pcs per codice).
Special Compactop Surfaces 10 (p. 378) available on demand (min. 20pcs each code).
Special Compactop Surfaces 10 (p. 378) disponibile su richiesta (min. 20pcs per codice).



Square section leg Sezione gamba quadrata

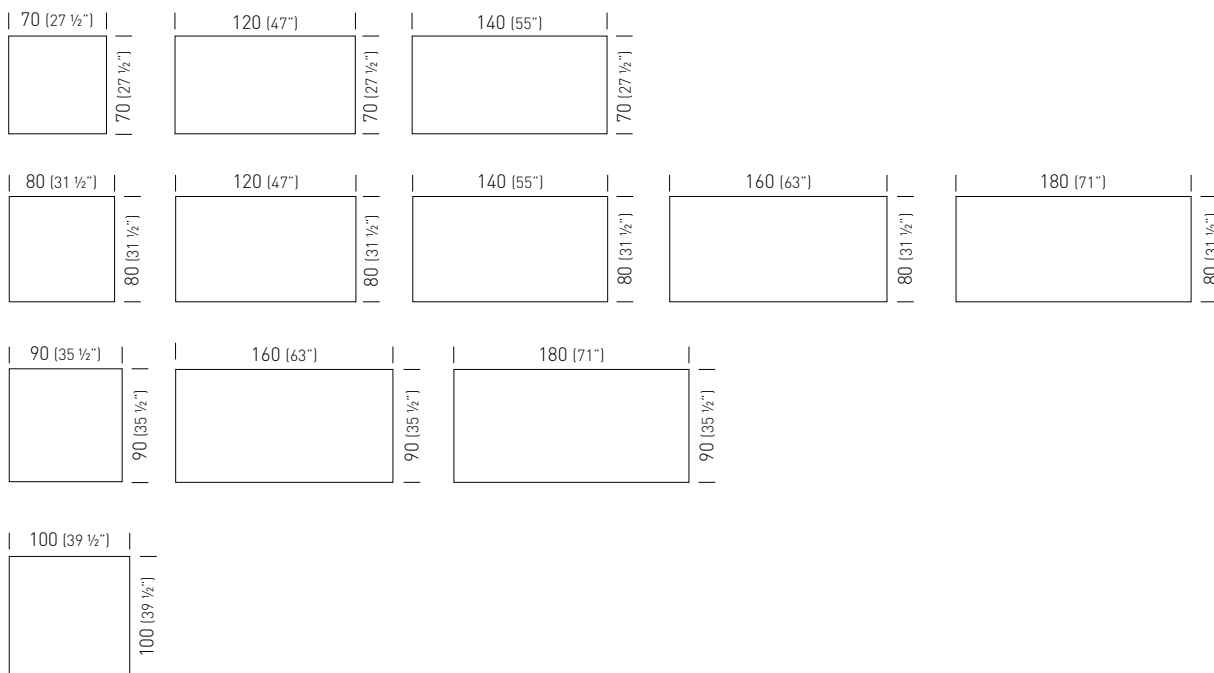

Size	Code	Volume	Weight	Unit	Price
70x70compactop	TPAQC700.___/H74	0.09m ³	19.30kg	1pc	2.495
80x80compactop	TPAQC708.___/H74	0.10m ³	19.80kg	1pc	2.895
90x90compactop	TPAQC718.___/H74	0.16m ³	22.30kg	1pc	3.495
100x100compactop	TPAQC728.___/H74	0.19m ³	26.30kg	1pc	3.995
120x70compactop	TPAQC702.___/H74	0.29m ³	36.80kg	1pc	4.295
120x80compactop	TPAQC710.___/H74	0.29m ³	39.30kg	1pc	4.595
140x70compactop	TPAQC704.___/H74	0.29m ³	41.80kg	1pc	5.295
140x80compactop	TPAQC712.___/H74	0.29m ³	43.10kg	1pc	5.695
160x80compactop	TPAQC714.___/H74	0.30m ³	45.80kg	1pc	6.695
160x90compactop	TPAQC724.___/H74	0.30m ³	48.80kg	1pc	7.195
180x80compactop	TPAQC716.___/H74	0.30m ³	48.80kg	1pc	7.195
180x90compactop	TPAQC726.___/H74	0.30m ³	51.80kg	1pc	7.695

DKK - kr

Pareo

Forsix Design

The Pareo Collection offers a wide range of beautifully designed dining and coffee tables. Thanks to their clean yet detailed design, Pareo tables suit a variety of hospitality settings, available in square, rectangular and round versions. The aluminum table frame, combined with Compact or Porcelain table tops, fits perfectly into even outdoor environments. Pareo Tables are made to be easily assembled and are available in a wide variety of bright frame colours and top finishes, perfectly matching your custom projects.

La collezione Pareo offre una vasta gamma di tavoli e tavolini dal design accattivante. Grazie alle loro linee essenziali e curate, i tavoli Pareo si adattano a diversi stili dedicati all'ospitalità e sono disponibili nella versione quadrata, rettangolare o rotonda. La struttura del tavolo, realizzata in alluminio, abbinata ai piani in Compact o Gres, si adatta perfettamente anche agli ambienti esterni. I tavoli Pareo sono realizzati per essere facilmente e velocemente assemblati e sono disponibili in un'ampia varietà di colori e finiture, perfetti per i vostri progetti personalizzati.



Frame Color / Colore Struttura

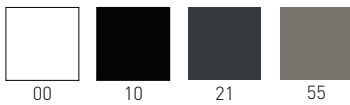

Laminated Top Color / Colore Piano Laminato



Special Finishes / Finiture Speciali

Laminated: Special Laminated Surfaces Wood Effect 25 (p. 383) available on demand (min. 20pcs each code)
 Special Laminated Surfaces Wood Effect 25 (p. 383) disponibile su richiesta (min. 20pcs per codice)
 Special Laminated Surfaces Fenix 25 (p. 384) available on demand (min. 20pcs each code)
 Special Laminated Surfaces Fenix 25 (p. 384) disponibile su richiesta (min. 20pcs per codice)

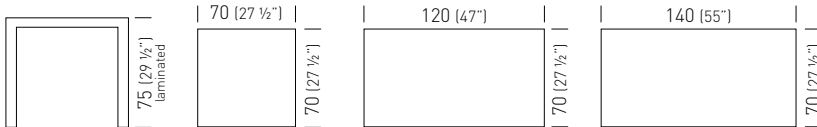

Square section leg Sezione gamba quadrata

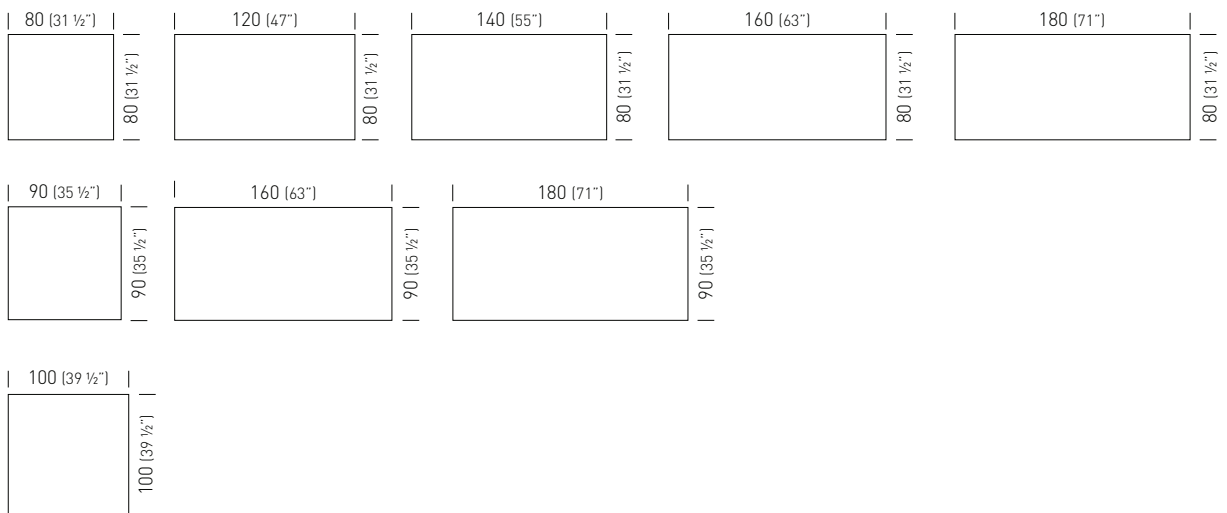

Table Size	Code	Weight	Price
70x70laminated	TPAQL740._._/H74	0.09m ³ / 19.30kg / 1pc	2.295
80x80laminated	TPAQL744._._/H74	0.10m ³ / 21.80kg / 1pc	2.695
90x90laminated	TPAQL749._._/H74	0.16m ³ / 23.30kg / 1pc	3.295
100x100laminated	TPAQL754._._/H74	0.19m ³ / 23.80kg / 1pc	3.795
120x70laminated	TPAQL741._._/H74	0.30m ³ / 35kg / 1pc	4.095
120x80laminated	TPAQL745._._/H74	0.30m ³ / 37.80kg / 1pc	4.395
140x70laminated	TPAQL742._._/H74	0.31m ³ / 39.80kg / 1pc	5.195
140x80laminated	TPAQL746._._/H74	0.31m ³ / 39.80kg / 1pc	5.495
160x80laminated	TPAQL747._._/H74	0.31m ³ / 40.80kg / 1pc	6.595
160x90laminated	TPAQL752._._/H74	0.31m ³ / 42.80kg / 1pc	6.995
180x80laminated	TPAQL748._._/H74	0.32m ³ / 42.80kg / 1pc	6.995
180x90laminated	TPAQL753._._/H74	0.32m ³ / 45.30kg / 1pc	7.595

DKK - kr

Pareo

Forsix Design



Only for compactop
solo per compactop

Frame Color / Colore Struttura

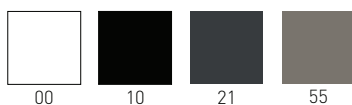

Compactop Color / Colore Piano Compactop

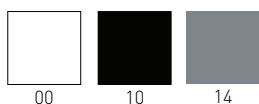

Laminated Top Color / Colore Piano Laminato



Special Finishes / Finiture Speciali

Compactop: Special Compactop Surfaces Fullcolor (p. 377) available on demand (min. 5pcs each code).
Special Compactop Surfaces Fullcolor (p. 377) disponibile su richiesta (min. 5pcs per codice).
Special Compactop Surfaces 10 (p. 378) available on demand (min. 20pcs each code).
Special Compactop Surfaces 10 (p. 378) disponibile su richiesta (min. 20pcs per codice).

Laminated: Special Laminated Surfaces Wood Effect 25 (p. 383) available on demand (min. 20pcs each code).
Special Laminated Surfaces Wood Effect 25 (p. 383) disponibile su richiesta (min. 20pcs per codice).
Special Laminated Surfaces Fenix 25 (p. 384) available on demand (min. 20pcs each code).
Special Laminated Surfaces Fenix 25 (p. 384) disponibile su richiesta (min. 20pcs per codice).

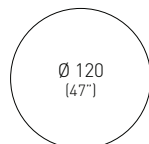
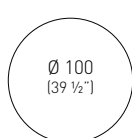

Round section leg
Sezione gamba rotonda

diam.100compactop	TPARC730.___/_/H74	0.30m ³ / 38.30kg / 1pc	DKK - kr	4.595	
diam.120compactop	TPARC732.___/_/H74	0.30m ³ / 43.80kg / 1pc			4.895
diam.100laminated	TPARL755.___/_/H74	0.28m ³ / 32.80kg / 1pc			4.295
diam.120laminated	TPARL756.___/_/H74	0.29m ³ / 36.30kg / 1pc			4.595

Pareo Marble

Forsix Design

The Pareo Marble tables utilizes a resistant aluminum and steel frame, fast and easy to assemble. The Marble tops, characterized by always different veins of natural stones, contribute to enhance elegance and refinement for the most demanding environments. The solid Marble surfaces, shiny and glossy, are treated to reduce their porosity, however constant care and cleaning of the product is recommended.

La collezione tavoli Pareo Marble utilizza un resistente telaio in alluminio e acciaio, facile ed intuitivo nell'assemblaggio. I piani in Marmo, caratterizzati dalle sempre diverse venature della pietra naturale, offrono eleganza e raffinatezza, per completare con esclusività gli ambienti più ricercati. I solidi piani in Marmo, splendenti e lucidi, sono trattati per ridurre la porosità, tuttavia si consiglia pulizia costante e cura nell'utilizzo del prodotto.



Frame Color / Colore Struttura

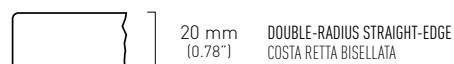
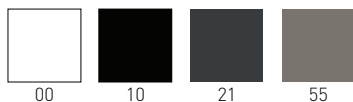

20 mm
(0.78")
DOUBLE-RADIUS STRAIGHT-EDGE
COSTA RETTA BISELLATA



MBC
BIANCO CARRARA



MNM
NERO MARQUINA



MVG
VERDE GUATEMALA



MED
EMPERADOR DARK

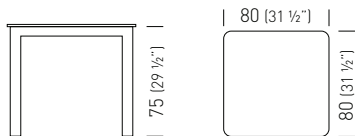

Round section leg
Sezione gamba rotonda

80x80

TPARAM760._._/H74



0.97m³ / 57.80kg / 1pc

DKK - kr

8.095

Pareo Porcelain

Forsix Design



The Pareo Porcelain tables utilizes a resistant aluminum and steel frame, fast and easy to assemble. The Porcelain stoneware tops stand out for their excellent technical performance, ideal for the most delicate uses where maximum hygiene and resistance must be guaranteed. Porcelain tops are compatible with foodstuffs, resistant to fungi and molds, suitable for both indoor and outdoor use, resistant to frost, heat and high temperatures, they can be cleaned very easily while maintaining the characteristics of the surface.

La collezione tavoli Pareo Porcelain utilizza un resistente telaio in alluminio e acciaio, facile ed intuitivo nell'assemblaggio. I piani in Gres Porcellanato si distinguono per le eccellenti performance tecniche, ideali negli impieghi più delicati nei quali è necessario garantire la massima igiene e resistenza. I piani Porcelain sono compatibili con le sostanze alimentari, resistenti a funghi e muffe, idonei ad un utilizzo sia interno che esterno, resistenti al gelo, al calore a alle alte temperature, si possono pulire con estrema facilità mantenendo inalterate le caratteristiche della superficie.

Frame Color / Colore Struttura

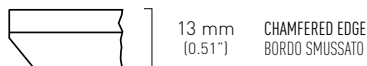
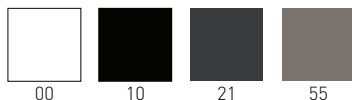

13 mm
(0.51") CHAMFERED EDGE
BORDO SMUSSATO



PCO
CALACATTA ORO



PNG
NERO GRECO

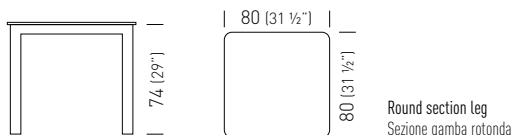

Round section leg
Sezione gamba rotonda

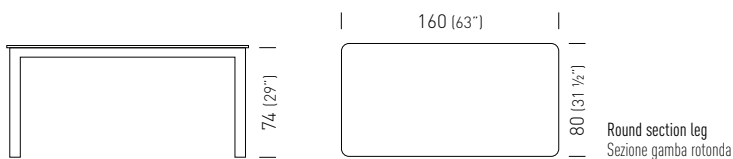

Round section leg
Sezione gamba rotonda

80x80
160x80

TPARP766.___/H74
TPARP768.___/H74

0.27m³ / 37,70kg / 1pc
 0.30m³ / 47,40kg / 1pc

DKK - kr

6.995
12.295

Min. order 10pcs
each code
Ordine min 10pz
per codice

Profilo

Studio Eurolinea Design

Compactop or Laminated table top
with painted metal frame. Adjustable feet.

Tavolo con struttura in metallo verniciato,
piano in Compactop o Laminato. Piedini regolabili



Frame Color / Colore Struttura



00

Compactop Color / Colore Piano Compactop



00



10



14

Laminated Top Color / Colore Piano Laminato



00



10



F



W



RN

Special Finishes / Finiture Speciali

Compactop: Special Compactop Surfaces Fullcolor (p. 377) available on demand (min. 5pcs each code).

Special Compactop Surfaces Fullcolor (p. 377) disponibile su richiesta (min. 5pcs per codice).

Special Compactop Surfaces 10 (p. 378) available on demand (min. 20pcs each code).

Special Compactop Surfaces 10 (p. 378) disponibile su richiesta (min. 20pcs per codice).

Laminated: Special Laminated Surfaces Wood Effect 25 (p. 383) available on demand (min. 20pcs each code).

Special Laminated Surfaces Wood Effect 25 (p. 383) disponibile su richiesta (min. 20pcs per codice).

Special Laminated Surfaces Fenix 25 (p. 384) available on demand (min. 20pcs each code).

Special Laminated Surfaces Fenix 25 (p. 384) disponibile su richiesta (min. 20pcs per codice).

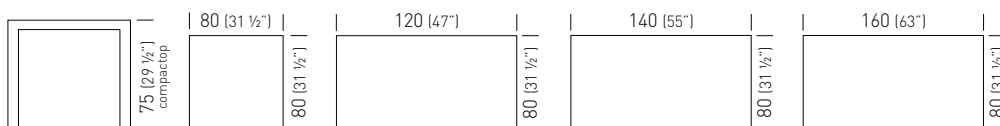

80x80compactop	TPROC500.___/_/H75		0.32m ³ / 24kg / 1pcs	DKK - kr	4.395
80x80laminated	TPROL518.___/_/H75		0.32m ³ / 24kg / 1pcs		3.895
80x120compactop	TPROC502.___/_/H75		0.43m ³ / 29kg / 1pcs		6.095
80x120laminated	TPROL520.___/_/H75		0.43m ³ / 29kg / 1pcs		4.795
80x140compactop	TPROC504.___/_/H75		0.48m ³ / 33kg / 1pcs		6.495
80x140laminated	TPROL522.___/_/H75		0.48m ³ / 33kg / 1pcs		5.295
80x160compactop	TPROC506.___/_/H75		0.53m ³ / 38kg / 1pcs		6.895
80x160laminated	TPROL524.___/_/H75		0.53m ³ / 38kg / 1pcs		5.695

Roller

Studio Eurolinea Design

Tables, chairs, benches and stools Collection.
 Compactop with technopolymer bases.
 Available illuminated and suitable for outdoor use.
 Collezione di tavoli, sedute, panche e sgabelli.
 I tavoli sono realizzati con piano Compactop
 e struttura in tecnopolimero.
 Disponibili con versione luminosa
 e adatti anche all'uso esterno.



Technopolymer Base Color / Colore Base Tecnopolimero

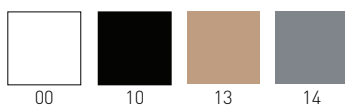

Compactop Color / Colore Piano Compactop

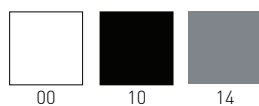

Special Finishes / Finiture Speciali

Compactop: Special Compactop Surfaces Fullcolor (p.377) white available on demand (min. 5pcs each code).
 Special Compactop Surfaces Fullcolor (p.377) bianco disponibile su richiesta (min. 5pcs per codice).

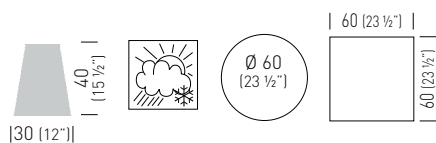

base	BROLLER._.__/H40	0.11m ³ / 2,5kg / 1pcs	DKK - kr	1.095
diam.60	TROLC040._.__/H40	0.18m ³ / 8kg / 1pcs		
60x60	TROLC044._.__/H40	0.18m ³ / 11,8kg / 1pcs		



Technopolymer Base Color / Colore Base Tecnopolimero

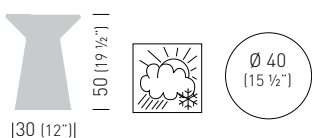
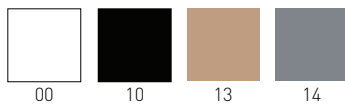

tavolino	244.--/A	0.1m ³ / 4kg / 1pcs	1.295
----------	----------	--------------------------------	--------------



Roller

Studio Eurolinea Design



230V – 50Hz
1 X 16W – Led Modul
IP 65

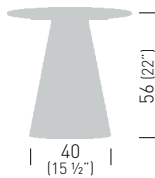

Technopolymer Base Color / Colore Base Tecnopolimero

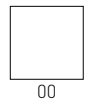

Led version with white transparent base.
Versione led con base in bianco trasparente.

Compact Color / Colore Piano Compacto

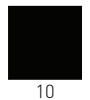
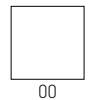

Special Finishes / Finiture Speciali

Compacto: Special Compacto Surfaces Fullcolor (p.377)
white available on demand (min. 5pcs each code).
Special Compacto Surfaces Fullcolor (p.377)
bianco disponibile su richiesta (min. 5pcs per codice).

base55	BROLLER.__/H55		0.13m ³ / 9.8kg / 1pcs	DKK - kr	1.295
base55 Led	BROLLER.__/H55L		0.13m ³ / 13kg / 1pcs		3.395



diam.60	TROLC040.__-/H55		0.21m ³ / 15.5kg / 1pcs		2.795
diam.60 Led	TROLC040.__-/H55L		0.21m ³ / 18.8kg / 1pcs		4.795



diam.68	TROLC048.__-/H55		0.23m ³ / 19kg / 1pcs		3.095
diam.68 Led	TROLC048.__-/H55L		0.23m ³ / 22.2kg / 1pcs		5.095

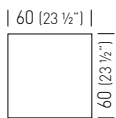

60x60	TROLC044.__-/H55		0.21m ³ / 17.5kg / 1pcs		2.495
60x60 Led	TROLC044.__-/H55L		0.21m ³ / 20.7kg / 1pcs		4.595

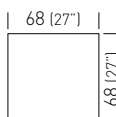

68x68	TROLC052.__-/H55		0.23m ³ / 20.5kg / 1pcs		2.695
68x68 Led	TROLC052.__-/H55L		0.23m ³ / 23.7kg / 1pcs		4.795

Roller

Studio Eurolinea Design



230V – 50Hz
1 X 16W – Led Modul
IP 65

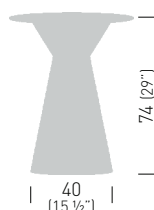

Technopolymer Base Color / Colore Base Tecnopolimero

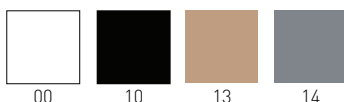

Compactop Color / Colore Piano Compactop

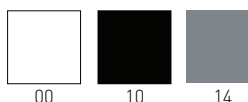

Special Finishes / Finiture Speciali

Compactop: Special Compactop Surfaces Fullcolor (p.377)
white available on demand (min. 5pcs each code).
Special Compactop Surfaces Fullcolor (p.377)
bianco disponibile su richiesta (min. 5pcs per codice).

Led version with white transparent base.
Versione led con base in bianco trasparente.

base74	BROLLER.__/H74	0.13m ³ / 11.30kg / 1pcs	DKK - kr	1.595
base74+20	BROLLER.__/H74+20	0.13m ³ / 31.30kg / 1pcs		1.795
base74 Led	BROLLER.__/H74L	0.13m ³ / 14.45kg / 1pcs		3.595
Ø 60 (23 1/2")	diam.60	TROLC040.___/H74	0.21m ³ / 16.8kg / 1pcs	2.995
	diam.60 Led	TROLC040.___/H74L	0.21m ³ / 19.9kg / 1pcs	5.095
Ø 68 (27")	diam.68	TROLC048.___/H74	0.23m ³ / 20.3kg / 1pcs	3.295
	diam.68 Led	TROLC048.___/H74L	0.23m ³ / 23.4kg / 1pcs	5.395
Ø 80 (31 1/2")	diam.80	TROLC056.___/H74	0.5m ³ / 22.3kg / 1pcs	4.395
	diam.80 Led	TROLC056.___/H74L	0.5m ³ / 25.5kg / 1pcs	6.495
Ø 100 (39 1/2")	diam.100	TROLC068.___/H74	0.67m ³ / 27kg / 1pcs	5.795
	diam.100 Led	TROLC068.___/H74L	0.67m ³ / 30kg / 1pcs	7.895
60 (23 1/2")	60x60	TROLC044.___/H74	0.21m ³ / 19.5kg / 1pcs	2.795
	60x60 Led	TROLC044.___/H74L	0.21m ³ / 22.5kg / 1pcs	4.795
68 (27")	68x68	TROLC052.___/H74	0.23m ³ / 21.8kg / 1pcs	2.995
	68x68 Led	TROLC052.___/H74L	0.23m ³ / 25kg / 1pcs	4.995
79 (31")	79x79	TROLC060.___/H74	0.50m ³ / 23.8kg / 1pcs	3.995
	79x79 Led	TROLC060.___/H74L	0.50m ³ / 27kg / 1pcs	6.095
89 (35")	89x89	TROLC064.___/H74	0.60m ³ / 24.8kg / 1pcs	4.995
	89x89 Led	TROLC064.___/H74L	0.60m ³ / 27.9kg / 1pcs	7.095

Roller

Studio Eurolinea Design

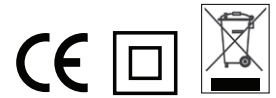

230V – 50Hz
1 X 16W – Led Modul
IP 65

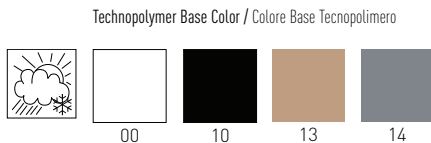
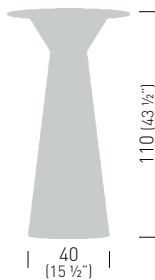

Technopolymer Base Color / Colore Base Tecnopolimero

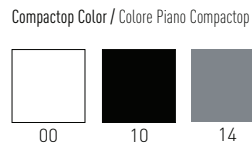

Compactop Color / Colore Piano Compactop

Special Finishes / Finiture Speciali

Compactop: Special Compactop Surfaces Fullcolor (p.377)
white available on demand (min. 5pcs each code).
Special Compactop Surfaces Fullcolor (p.377)
bianco disponibile su richiesta (min. 5pcs per codice).

Led version with white transparent base.
Versione led con base in bianco trasparente.

base110	BROLLER._/_/H110		0.2m ³ / 11.30kg / 1pcs	DKK - kr	2.395
base110+20	BROLLER._/_/H110+20		0.2m ³ / 31.30kg / 1pcs		2.595
base110 Led	BROLLER._/_/H110L		0.2m ³ / 14.45kg / 1pcs		4.395

Ø 60 (23 1/2")	diam.60	TROLC040._/_/H110		0.28m ³ / 20.6kg / 1pcs	3.795
	diam.60 Led	TROLC040._/_/H110L		0.28m ³ / 23.8kg / 1pcs	5.895

Ø 68 (27")	diam.68	TROLC048._/_/H110		0.31m ³ / 24.1kg / 1pcs	4.195
	diam.68 Led	TROLC048._/_/H110L		0.31m ³ / 27.3kg / 1pcs	6.195

Ø 80 (31 1/2")	diam.80	TROLC056._/_/H110		0.5m ³ / 26.1kg / 1pcs	4.995
	diam.80 Led	TROLC056._/_/H110L		0.5m ³ / 29.3kg / 1pcs	7.095

60 (23 1/2")	60x60	TROLC044._/_/H110		0.28m ³ / 22.8kg / 1pcs	3.595
	60x60 Led	TROLC044._/_/H110L		0.28m ³ / 26kg / 1pcs	5.595

68 (27")	68x68	TROLC052._/_/H110		0.31m ³ / 25.6kg / 1pcs	3.795
	68x68 Led	TROLC052._/_/H110L		0.31m ³ / 28.8kg / 1pcs	5.895

79 (31")	79x79	TROLC060._/_/H110		0.5m ³ / 27.6kg / 1pcs	4.595
	79x79 Led	TROLC060._/_/H110L		0.5m ³ / 30.8kg / 1pcs	6.695

Roller

Studio Eurolinea Design

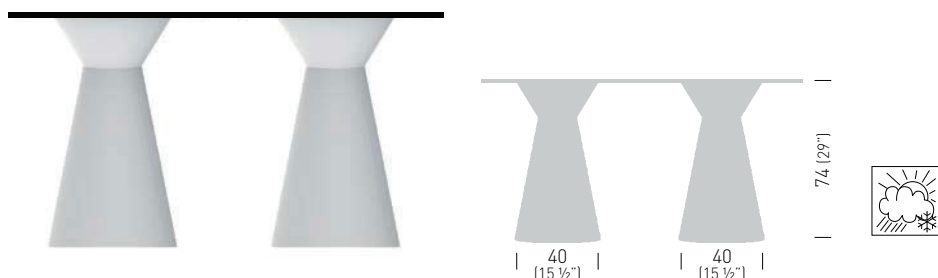

230V – 50Hz
1 X 16W – Led Modul
IP 65

Technopolymer Base Color / Colore Base Tecnochimero

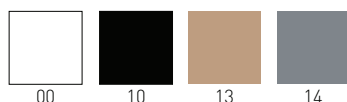

Compactop Color / Colore Piano Compactop

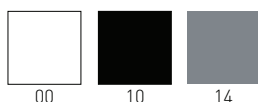

Special Finishes / Finiture Speciali

Compactop: Special Compactop Surfaces Fullcolor (p.377) white available on demand (min. 5pcs each code).
Special Compactop Surfaces Fullcolor (p.377) bianco disponibile su richiesta (min. 5pcs per codice).

Led version with white transparent base.
Versione led con base in bianco trasparente.

Dimensions (mm / inches)	Base	Code	Volume / Weight	Options	Price
120 (47")	base74	BROLLER.__/2H74	0.26m ³ / 22.60kg / 1pcs	DKK - kr	3.195
120x50 (19 1/2")	120x50	TROLC072.__-/2H74	0.56m ³ / 38.1kg / 1pcs		6.495
120x80 (31 1/2")	120x80	TROLC076.__-/2H74	0.56m ³ / 39.1kg / 1pcs		6.495
140 (55")	140x70	TROLC080.__-/2H74	0.66m ³ / 42.6kg / 1pcs		6.895
159 (62 1/2")	159x79	TROLC084.__-/2H74	0.94m ³ / 45.6kg / 1pcs		8.095
120 (47")	base110	BROLLER.__/2H110	0.38m ³ / 30.2kg / 1pcs		4.695
120x50 (19 1/2")	120x50	TROLC072.__-/H110	0.66m ³ / 45.7kg / 1pcs		7.995
120x80 (31 1/2")	120x80	TROLC076.__-/H110	0.66m ³ / 46.7kg / 1pcs		7.995
140 (55")	140x70	TROLC080.__-/H110	0.84m ³ / 50.2kg / 1pcs		8.695
159 (62 1/2")	159x79	TROLC084.__-/H110	1.04m ³ / 53.2kg / 1pcs		9.595

Saturno

Studio Eurolinea Design

Compactop with painted aluminum frame.
Tavolo con piano Compactop e struttura in alluminio verniciato.



Base Color / Colore Base



Top Color / Colore Piano

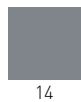

Special Finishes / Finiture Speciali

Compactop: Special Compactop Surfaces Fullcolor (p. 377) available on demand (min. 5pcs each code).
Special Compactop Surfaces Fullcolor (p. 377) disponibile su richiesta (min. 5pcs per codice).
Special Compactop Surfaces 10 (p. 378) available on demand (min. 20pcs each code).
Special Compactop Surfaces 10 (p. 378) disponibile su richiesta (min. 20pcs per codice).

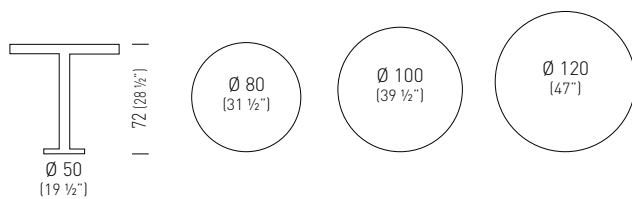

diam.80
diam.100
diam.120

TSATC142.___/H72
TSATC146.___/H72
TSATC150.___/H72

0.56m³ / 28kg / 1pcs
 0.74m³ / 30kg / 1pcs
 0.87m³ / 33kg / 1pcs

DKK - kr

9.295
11.195
12.995



diam.130
diam.140
diam.150
diam.160

TSATC153.___/H72
TSATC156.___/H72
TSATC159.___/H72
TSATC162.___/H72

0.90m³ / 50kg / 1pcs
 0.90m³ / 53kg / 1pcs
 0.90m³ / 56kg / 1pcs
 1.10m³ / 59kg / 1pcs

14.295
15.095
16.595
19.695

Saturnino

Studio Eurolinea Design



Waiting areas and Coffee Table,
Compactop with painted aluminum frame.
Tavolino attesa con piano Compactop
e struttura in alluminio verniciato.

Base Color / Colore Base



00

Top Color / Colore Piano



00
Fullcolor

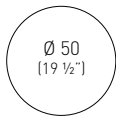
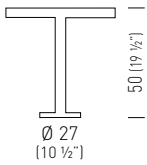

diam.50

TSATC140._._/H50

 0.3m³ / 10kg / 1pcs

DKK - kr

4.695

Simply

Studio Eurolinea Design

Stackable table with laminated or Iron top and painted metal frame.

Tavolo impilabile con piano in laminato o Iron e telaio in metallo verniciato.



Only Iron Top
Solo Iron top



Frame Color / Colore Struttura

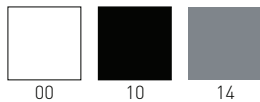

Iron Top Color / Colore Piano Iron

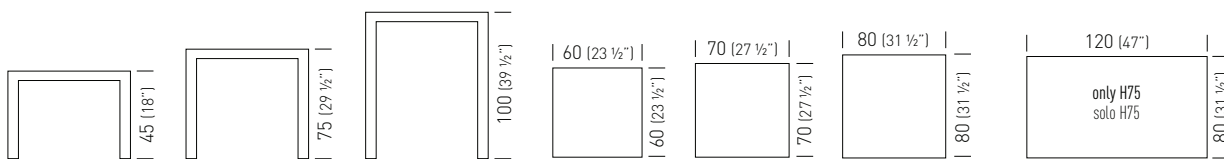
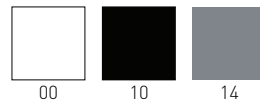

Dimensions	Code	Material	Volume / Weight	Material	Price
60x60	TSIMI430._._/H45		0.28m³ / 17.0kg / 1pcs	DKK - kr	3.095
60x60	TSIMI430._._/H75		0.28m³ / 17.5kg / 1pcs		3.095
60x60	TSIMI430._._/H100		0.28m³ / 18.5kg / 1pcs		3.395
70x70	TSIMI432._._/H45		0.28m³ / 18.0kg / 1pcs		3.195
70x70	TSIMI432._._/H75		0.28m³ / 18.5kg / 1pcs		3.195
70x70	TSIMI432._._/H100		0.28m³ / 19.5kg / 1pcs		3.495
80x80	TSIMI434._._/H45		0.40m³ / 19.0kg / 1pcs		3.695
80x80	TSIMI434._._/H75		0.40m³ / 19.5kg / 1pcs		3.695
80x80	TSIMI434._._/H100		0.40m³ / 20.5kg / 1pcs		3.995
120x80	TSIMI436._._/H75		0.40m³ / 25.0kg / 1pcs		4.695

Frame Color / Colore Struttura

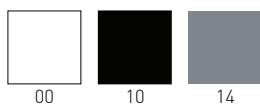

Laminated Top Color / Colore Piano Laminato



Special Finishes / Finiture Speciali

Laminated: Special Laminated Surfaces Wood Effect 25 (p. 383) available on demand (min. 20pcs each code).
Special Laminated Surfaces Wood Effect 25 (p. 383) disponibile su richiesta (min. 20pcs per codice).
Special Laminated Surfaces Fenix 25 (p. 384) available on demand (min. 20pcs each code).
Special Laminated Surfaces Fenix 25 (p. 384) disponibile su richiesta (min. 20pcs per codice).

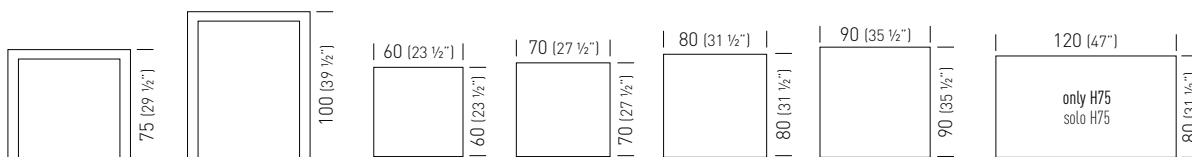

Dimensions	Code	Material	Volume / Weight	Price
60x60	TSIML438._._/H75		0.28m³ / 16kg / 1pcs	5.095
60x60	TSIML438._._/H100		0.28m³ / 17kg / 1pcs	5.095
70x70	TSIML440._._/H75		0.28m³ / 17kg / 1pcs	2.695
70x70	TSIML440._._/H100		0.28m³ / 18kg / 1pcs	2.895
80x80	TSIML442._._/H75		0.40m³ / 18.5kg / 1pcs	3.195
80x80	TSIML442._._/H100		0.40m³ / 19.5kg / 1pcs	3.495
90x90	TSIML444._._/H75		0.40m³ / 21kg / 1pcs	3.295
90x90	TSIML444._._/H100		0.40m³ / 22kg / 1pcs	3.495
120x80	TSIML446._._/H75		0.40m³ / 23.5kg / 1pcs	3.995

Space

Studio Eurolinea Design



Innovative and durable, the Space table is characterized by a thin Compactop profile and a solid four-legged structure in anodized aluminum. Resistant to stains, abrasions and thermal variations, the table can also be used for intensive use.

Innovativo e durevole, il tavolo Space è caratterizzato da un piano in Compactop dal profilo sottile e da una solida struttura a quattro gambe in alluminio anodizzato. Resistente alle macchie, alle abrasioni e alle variazioni termiche, il tavolo può essere utilizzato anche per utilizzi intensivi.

Frame Color / Colore Struttura



Anodized aluminum
Alluminio anodizzato

Compactop Color / Colore Piano Compactop



00



10



14

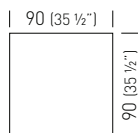
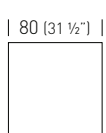
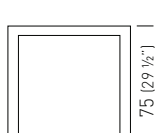

80x80
90x90

TSPAC410.__-/H75
TSPAC412.__-/H75



0.36m³ / 19kg / 1pcs
0.36m³ / 21kg / 1pcs

DKK - kr

5.895
6.295

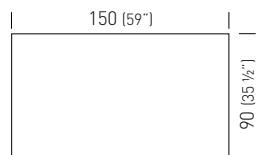
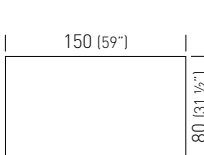
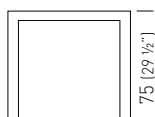

80x150
90x150

TSPAC414.__-/H75
TSPAC416.__-/H75



0.68m³ / 28kg / 1pcs
0.68m³ / 30kg / 1pcs

7.995
8.495

Stefano

Studio Eurolinea Design

Compactop table-top and beech legs.
Or with technopolymer legs,
suitable for outdoor use. Lightweight and functional.
Tavolo con piano Compactop e gambe in legno di faggio.
Disponibile anche con gambe in tecnopolimero,
adatte all'uso esterno. Leggero e funzionale.



Wooden Frame Color / Colore Struttura Legno

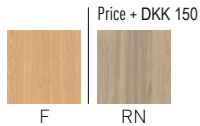

Top Color / Colore Piano

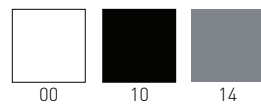

Special Finishes / Finiture Speciali

Compactop: Special Compactop Surfaces 10 (p. 378) available on demand (min. 20pcs each code).
Special Compactop Surfaces 10 (p. 378) disponibile su richiesta (min. 20pcs per codice).

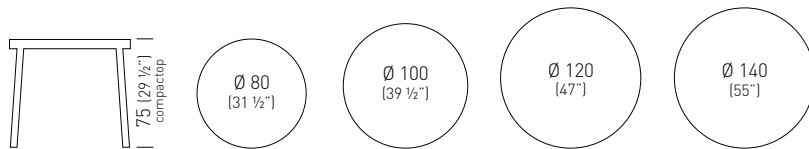

diam.80	TSTEC102. __-_/H75	0.4m ³ / 18kg / 1pcs	DKK - kr	4.295
diam.80 fullcolor straight edge / bordo dritto (min 5pcs)	TSTEC103. __-_/H75	0.4m ³ / 18kg / 1pcs		4.895
diam.80 fullcolor inclined edge / bordo inclinato (min 5pcs)	TSTEC104. __-_/H75	0.4m ³ / 18kg / 1pcs		4.895
diam.100	TSTEC114. __-_/H75	0.58m ³ / 19kg / 1pcs		5.495
diam.100 fullcolor straight edge / bordo dritto (min 5pcs)	TSTEC115. __-_/H75	0.58m ³ / 19kg / 1pcs		6.195
diam.100 fullcolor inclined edge / bordo inclinato (min 5pcs)	TSTEC116. __-_/H75	0.58m ³ / 19kg / 1pcs		6.195
diam.120	TSTEC122. __-_/H75	0.71m ³ / 20kg / 1pcs		6.595
diam.120 fullcolor straight edge / bordo dritto (min 5pcs)	TSTEC123. __-_/H75	0.71m ³ / 20kg / 1pcs		7.395
diam.120 fullcolor inclined edge / bordo inclinato (min 5pcs)	TSTEC124. __-_/H75	0.71m ³ / 20kg / 1pcs		7.395
diam.140	TSTEC129. __-_/H75	0.87m ³ / 24kg / 1pcs		7.595
diam.140 fullcolor straight edge / bordo dritto (min 5pcs)	TSTEC130. __-_/H75	0.87m ³ / 24kg / 1pcs		8.495
diam.140 fullcolor inclined edge / bordo inclinato (min 5pcs)	TSTEC131. __-_/H75	0.87m ³ / 24kg / 1pcs		8.495

Technopolymer Frame Color / Colore Struttura Tecnopolimero

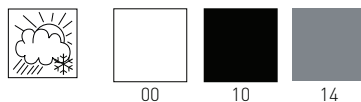

Top Color / Colore Piano

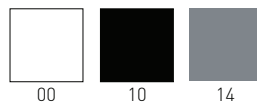

Special Finishes / Finiture Speciali

Compactop: Special Compactop Surfaces 10 (p. 378) available on demand (min. 20pcs each code).
Special Compactop Surfaces 10 (p. 378) disponibile su richiesta (min. 20pcs per codice).

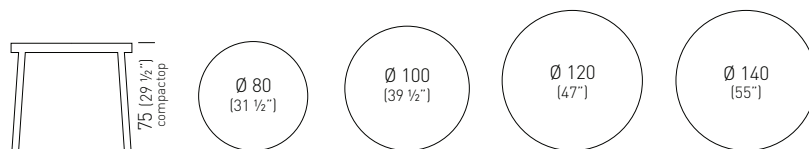

diam.80	TSTEC102. __-_/H75	0.4m ³ / 18kg / 1pcs	4.295
diam.80 fullcolor straight edge / bordo dritto (min 5pcs)	TSTEC103. __-_/H75	0.4m ³ / 18kg / 1pcs	4.895
diam.80 fullcolor inclined edge / bordo inclinato (min 5pcs)	TSTEC104. __-_/H75	0.4m ³ / 18kg / 1pcs	4.895
diam.100	TSTEC114. __-_/H75	0.58m ³ / 19kg / 1pcs	5.495
diam.100 fullcolor straight edge / bordo dritto (min 5pcs)	TSTEC115. __-_/H75	0.58m ³ / 19kg / 1pcs	6.195
diam.100 fullcolor inclined edge / bordo inclinato (min 5pcs)	TSTEC116. __-_/H75	0.58m ³ / 19kg / 1pcs	6.195
diam.120	TSTEC122. __-_/H75	0.71m ³ / 20kg / 1pcs	6.595
diam.120 fullcolor straight edge / bordo dritto (min 5pcs)	TSTEC123. __-_/H75	0.71m ³ / 20kg / 1pcs	7.395
diam.120 fullcolor inclined edge / bordo inclinato (min 5pcs)	TSTEC124. __-_/H75	0.71m ³ / 20kg / 1pcs	7.395
diam.140	TSTEC129. __-_/H75	0.87m ³ / 24kg / 1pcs	7.595
diam.140 fullcolor straight edge / bordo dritto (min 5pcs)	TSTEC130. __-_/H75	0.87m ³ / 24kg / 1pcs	8.495
diam.140 fullcolor inclined edge / bordo inclinato (min 5pcs)	TSTEC131. __-_/H75	0.87m ³ / 24kg / 1pcs	8.495

Stefano

Studio Eurolinea Design



Compactop table-top and beech legs.
Or with technopolymer legs,
suitable for outdoor use. Lightweight and functional.
Tavolo con piano Compactop e gambe in legno di faggio.
Disponibile anche con gambe in tecnopolimero,
adatte all'uso esterno. Leggero e funzionale.

Wooden Frame Color / Colore Struttura Legno

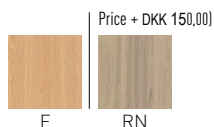

Top Color / Colore Piano

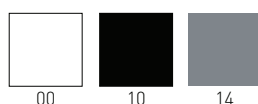

Special Finishes / Finiture Speciali

Compactop: Special Compactop Surfaces 10 (p. 378) available on demand (min. 20pcs each code).
Special Compactop Surfaces 10 (p. 378) disponibile su richiesta (min. 20pcs per codice).

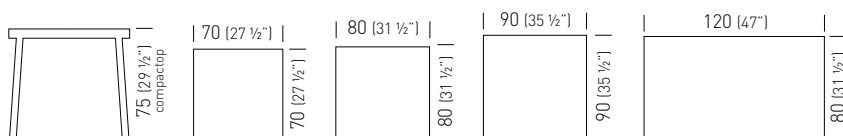

70x70	70x70 fullcolor straight edge / bordo dritto (min 5pcs)	70x70 fullcolor inclined edge / bordo inclinato (min 5pcs)
80x80	80x80 fullcolor straight edge / bordo dritto (min 5pcs)	80x80 fullcolor inclined edge / bordo inclinato (min 5pcs)
90x90	90x90 fullcolor straight edge / bordo dritto (min 5pcs)	90x90 fullcolor inclined edge / bordo inclinato (min 5pcs)
120x80	120x80 fullcolor straight edge / bordo dritto (min 5pcs)	120x80 fullcolor inclined edge / bordo inclinato (min 5pcs)

TSTEC098._._/H75	0.40m ³ / 17kg / 1pcs
TSTEC099._._/H75	0.40m ³ / 17kg / 1pcs
TSTEC100._._/H75	0.40m ³ / 17kg / 1pcs
TSTEC106._._/H75	0.40m ³ / 18kg / 1pcs
TSTEC107._._/H75	0.40m ³ / 18kg / 1pcs
TSTEC108._._/H75	0.40m ³ / 18kg / 1pcs
TSTEC110._._/H75	0.40m ³ / 18.5kg / 1pcs
TSTEC111._._/H75	0.40m ³ / 18.5kg / 1pcs
TSTEC112._._/H75	0.40m ³ / 18.5kg / 1pcs
TSTEC126._._/H75	0.52m ³ / 20kg / 1pcs
TSTEC127._._/H75	0.52m ³ / 20kg / 1pcs
TSTEC128._._/H75	0.52m ³ / 20kg / 1pcs

DKK - kr	3.95
	4.195
	4.195
	3.895
	4.395
	4.395
	4.295
	4.995
	4.995
	5.295
	5.995
	5.995

Technopolymer Frame Color / Colore Struttura Tecnopolimero

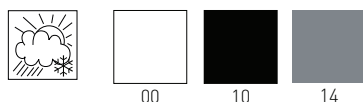

Top Color / Colore Piano

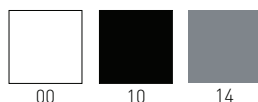

Special Finishes / Finiture Speciali

Compactop: Special Compactop Surfaces 10 (p. 378) available on demand (min. 20pcs each code).
Special Compactop Surfaces 10 (p. 378) disponibile su richiesta (min. 20pcs per codice).

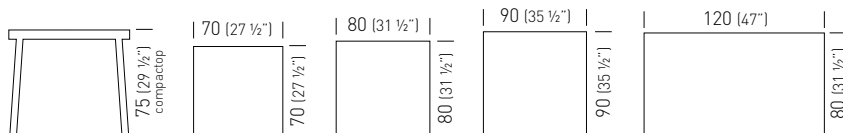

70x70	70x70 fullcolor straight edge / bordo dritto (min 5pcs)	70x70 fullcolor inclined edge / bordo inclinato (min 5pcs)
80x80	80x80 fullcolor straight edge / bordo dritto (min 5pcs)	80x80 fullcolor inclined edge / bordo inclinato (min 5pcs)
90x90	90x90 fullcolor straight edge / bordo dritto (min 5pcs)	90x90 fullcolor inclined edge / bordo inclinato (min 5pcs)
120x80	120x80 fullcolor straight edge / bordo dritto (min 5pcs)	120x80 fullcolor inclined edge / bordo inclinato (min 5pcs)

TSTEC098._._/H75	0.40m ³ / 17kg / 1pcs
TSTEC099._._/H75	0.40m ³ / 17kg / 1pcs
TSTEC100._._/H75	0.40m ³ / 17kg / 1pcs
TSTEC106._._/H75	0.40m ³ / 18kg / 1pcs
TSTEC107._._/H75	0.40m ³ / 18kg / 1pcs
TSTEC108._._/H75	0.40m ³ / 18kg / 1pcs
TSTEC110._._/H75	0.40m ³ / 18.5kg / 1pcs
TSTEC111._._/H75	0.40m ³ / 18.5kg / 1pcs
TSTEC112._._/H75	0.40m ³ / 18.5kg / 1pcs
TSTEC126._._/H75	0.52m ³ / 20kg / 1pcs
TSTEC127._._/H75	0.52m ³ / 20kg / 1pcs
TSTEC128._._/H75	0.52m ³ / 20kg / 1pcs

3.695
4.195
4.195
3.895
4.395
4.395
4.295
4.995
4.995
5.295
5.995
5.995

Stefano 3-Pod

Studio Eurolinea Design

Waiting areas and Coffee Table,
Compactop with three beech legs.
Tavolino attesa con piano Compactop
e tre gambe in legno di faggio.



Wooden Frame Color / Colore Struttura Legno

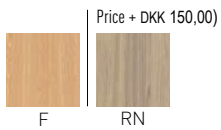

Top Color / Colore Piano

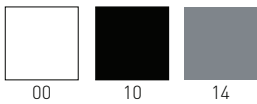

Special Finishes / Finiture Speciali

Compactop: Special Compactop Surfaces Fullcolor (p. 377) white available on demand (min. 5pcs each code).
Special Compactop Surfaces Fullcolor (p. 377) bianco disponibile su richiesta (min. 5pcs per codice).

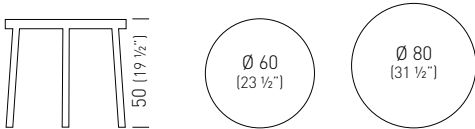

diam.60
diam.80

TSTEC090.___/3H50
TSTEC102.___/3H50

0.30m³ / 17kg / 1pcs
 0.40m³ / 18kg / 1pcs

DKK - kr

3.295
3.995

Stefanino

Studio Eurolinea Design

Waiting areas and Coffee Table,
Compactop with beech legs.
Tavolino attesa con piano Compactop
e gambe in legno di faggio.



Wooden Frame Color / Colore Struttura Legno



F

Top Color / Colore Piano



00



10



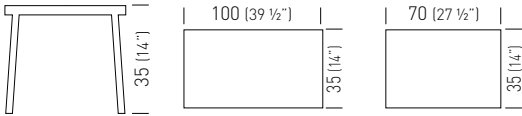

14

Fullcolor



100x35
70x35

TSTEC118.__-_/H35
TSTEC094.__-_/H35

 0.34m³ / 10kg / 1pcs
 0.34m³ / 7kg / 1pcs

DKK - kr

2.995
2.895

Step

Studio Eurolinea Design

High table, co-injected metal frame with techno polymer, Compactop.

Suitable for outdoor purpose.
Tavolo alto con struttura in metallo sovrastampato con tecnopolimero, piano in Compactop.
Adatto anche all'uso esterno.



Technopolymer Frame Color / Colore Struttura Tecnopolimero

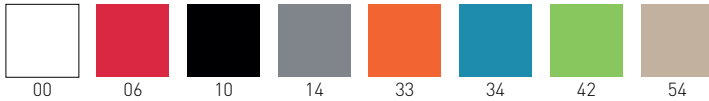

Compactop Color / Colore Piano Compactop

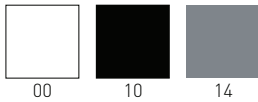

Special Finishes / Finiture Speciali

Compactop: Special Compactop Surfaces 10 (p. 378) available on demand (min. 20pcs each code).
Special Compactop Surfaces 10 (p. 378) disponibile su richiesta (min. 20pcs per codice).

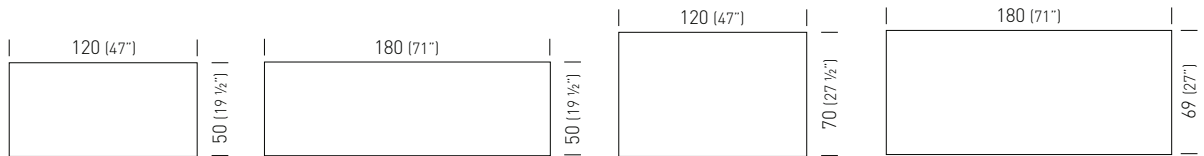

Size	Code	Weight	Material	Price
120x50	TSTPC820.___/H110	0.47m ³ / 35kg / 1pcs	DKK - kr	5.595
120x50fullcolor (min 5pcs)	TSTPC821.00-_/H110	0.47m ³ / 35kg / 1pcs		5.995
120x70	TSTPC822.___/H110	0.48m ³ / 36kg / 1pcs		5.895
120x70fullcolor (min 5pcs)	TSTPC823.00-_/H110	0.48m ³ / 36kg / 1pcs		6.695
180x50	TSTPC824.___/H110	0.60m ³ / 42kg / 1pcs		6.195
180x50fullcolor (min 5pcs)	TSTPC825.00-_/H110	0.60m ³ / 42kg / 1pcs		6.995
180x69	TSTPC826.___/H110	0.60m ³ / 43kg / 1pcs		6.395
180x69fullcolor (min 5pcs)	TSTPC827.00-_/H110	0.60m ³ / 43kg / 1pcs		7.295



Surfy 2027 Tables & Desks



Table collection, meeting tables and modular desks, part of the "2027" system, suitable for completing hospitality and office settings with integrated design. The tables are made with painted metal structures and Laminate or Compactop table-tops, available with metal fairlead solutions.

Collezione tavoli, tavoli meeting e scrivanie modulari, parte del sistema "2027", adatti a completare con lo stesso design progetti integrati di ospitalità ed ufficio. I tavoli sono realizzati con strutture in metallo verniciato e piani in Laminate o Compactop, disponibili con soluzioni passacavi in metallo. Strutture di sostegno con forma a cavalletto per essere snelle e resistenti, oltre che colorate a tutto tondo.

Finishings / Finiture

Frame colors / Colori struttura



00

10

16

21

22

35

55

Laminated top color / Colori piano laminato

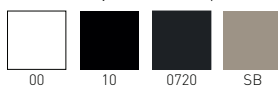

00

10

0720

Fenix

SB

SURFY HUB 2027 ROUND



Frame colors / Colori struttura

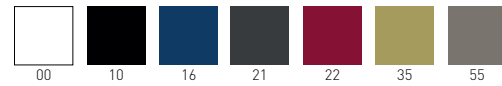

Laminated Top Color / Colore Piano Laminato



diam. 120laminated
diam. 120lam.fenix
diam. 140laminated
diam. 140lam.fenix
diam. 160laminated
diam. 160lam.fenix

TSRHL260.___/H74
TSRHL260.0720-_/H74
TSRHL262.___/H74
TSRHL262.0720-_/H74
TSRHL264.___/H74
TSRHL264.0720-_/H74

0.71m³ / 30kg / 1pcs
0.71m³ / 30kg / 1pcs
0.90m³ / 37kg / 1pcs
0.90m³ / 37kg / 1pcs
1.1m³ / 43kg / 1pcs
1.1m³ / 43kg / 1pcs

DKK - kr

6.995
8.395
8.995
11.395
14.095
18.295

SURFY HUB 2027 SQUARE



Frame colors / Colori struttura



Laminated Top Color / Colore Piano Laminato

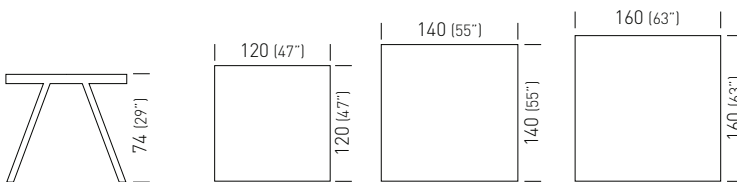

120x120laminated
120x120lam.fenix
140x140laminated
140x140lam.fenix
160x160laminated
160x160lam.fenix

TSRHL261.___/H74
TSRHL261.0720-_/H74
TSRHL263.___/H74
TSRHL263.0720-_/H74
TSRHL265.___/H74
TSRHL265.0720-_/H74

0.71m³ / 34kg / 1pcs
0.71m³ / 34kg / 1pcs
0.90m³ / 41kg / 1pcs
0.90m³ / 41kg / 1pcs
1.1m³ / 50kg / 1pcs
1.1m³ / 50kg / 1pcs

6.995
8.395
8.995
11.395
14.095
18.295

SURFY OUTDOOR 2027 ROUND



Frame colors / Colori struttura

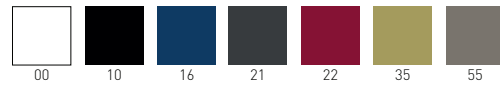

Laminated Top Color / Colore Piano Laminato

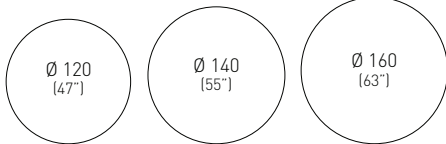
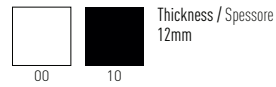

diam. 120Compactop
diam. 140Compactop
diam. 160Compactop

TSROC280._-_/H73
TSROC286._-_/H73
TSROC292._-_/H73

0.71m³ / 35kg / 1pcs
0.90m³ / 41kg / 1pcs
1.1m³ / 49kg / 1pcs

DKK - kr

8.095
11.195
16.895

SURFY OUTDOOR 2027 SQUARE



Frame colors / Colori struttura

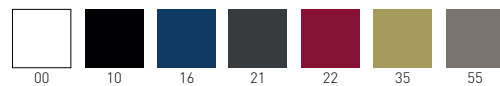

Laminated Top Color / Colore Piano Laminato

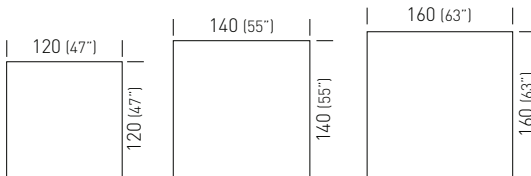
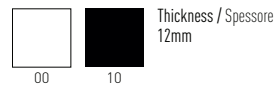

120x120Compactop
140x140Compactop
160x160Compactop

TSROC283._-_/H73
TSROC289._-_/H73
TSROC295._-_/H73

0.71m³ / 39kg / 1pcs
0.90m³ / 49kg / 1pcs
1.1m³ / 59kg / 1pcs

DKK - kr

8.095
11.195
16.895

SURFY HUB 2027 OVAL



Frame colors / Colori struttura

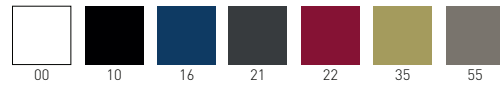

Laminated Top Color / Colore Piano Laminato

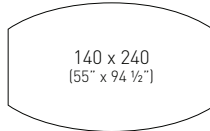
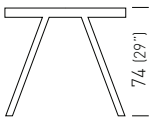
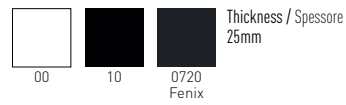

140x240laminated
140x240lam.fenix

TSRHL275.___/H74
TSRHL275.0720-_/H74

1.50m³ / 74kg / 1pcs
 1.50m³ / 74kg / 1pcs

20.795
23.095



Option: Cod. ACCV030.___
Metal Fairlead Solution
Tubo metallico passacavi
DKK 475

Colors / Colori

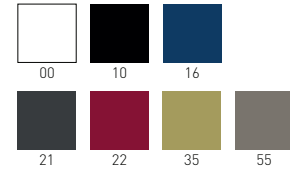

SURFY HUB 2027 RECTANGLE



Frame colors / Colori struttura

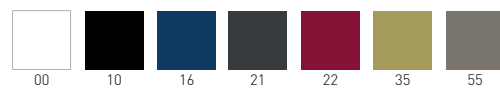

Laminated Top Color / Colore Piano Laminato

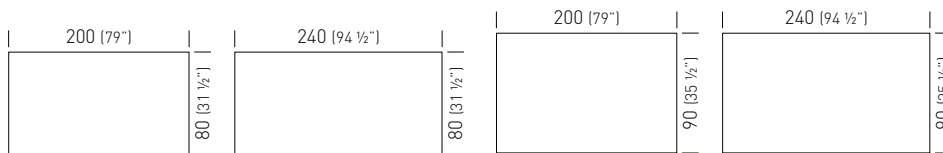
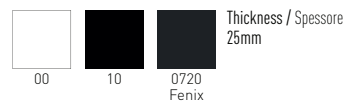

80x200laminated
80x200lam.fenix
80x240laminated
80x240lam.fenix
90x200laminated
90x200lam.fenix
90x240laminated
90x240lam.fenix

TSRHL266.___/H74
TSRHL266.0720-_/H74
TSRHL267.___/H74
TSRHL267.0720-_/H74
TSRHL268.___/H74
TSRHL268.0720-_/H74
TSRHL269.___/H74
TSRHL269.0720-_/H74

0.76m³ / 41kg / 1pcs
 0.76m³ / 41kg / 1pcs
 0.90m³ / 46kg / 1pcs
 0.90m³ / 46kg / 1pcs
 0.90m³ / 44kg / 1pcs
 0.90m³ / 44kg / 1pcs
 1.0m³ / 51kg / 1pcs
 1.0m³ / 51kg / 1pcs

DKK - kr

8.995
10.295
10.295
11.895
10.195
11.595
11.495
13.195



Option: Cod. ACCV030.___
Metal Fairlead Solution
Tubo metallico passacavi
DKK 475

Colors / Colori

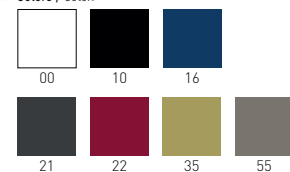

SURFY HUB 2027 RECTANGLE



Frame colors / Colori struttura

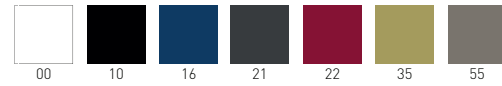

Laminated Top Color / Colore Piano Laminato

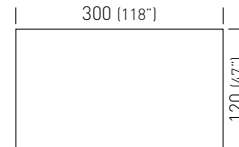
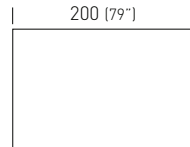

- 100x200laminated
- 100x200lam.fenix
- 100x300laminated
- 100x300lam.fenix
- 120x200laminated
- 120x200lam.fenix
- 120x300laminated
- 120x300lam.fenix

- TSRHL270.__-_/H74
- TSRHL270.0720-_/H74
- TSRHL271.__-_/H74
- TSRHL271.0720-_/H74
- TSRHL272.__-_/H74
- TSRHL272.0720-_/H74
- TSRHL273.__-_/H74
- TSRHL273.0720-_/H74

- 0.92m³ / 45kg / 1pcs DKK - kr
- 0.92m³ / 45kg / 1pcs
- 1.4m³ / 65kg / 1pcs
- 1.4m³ / 65kg / 1pcs
- 1.1m³ / 52kg / 1pcs
- 1.1m³ / 52kg / 1pcs
- 1.6m³ / 74kg / 1pcs
- 1.6m³ / 74kg / 1pcs

- 10.095
- 11.495
- 16.995
- 19.295
- 11.395
- 12.895
- 19.495
- 21.795



Option: Cod. ACCV030.___
Metal Fairlead Solution
Tubo metallico passacavi
DKK 475

Colors / Colori

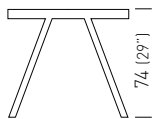
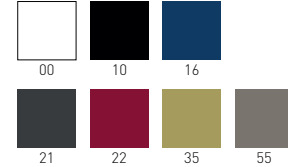

- 140x300laminated
- 140x300lam.fenix

- TSRHL276.__-_/H74
- TSRHL276.0720-_/H74

- 1.9m³ / 81kg / 1pcs
- 1.9m³ / 81kg / 1pcs

- 22.795
- 25.495



Option: Cod. ACCV030.___
Metal Fairlead Solution
Tubo metallico passacavi
DKK 475

Colors / Colori

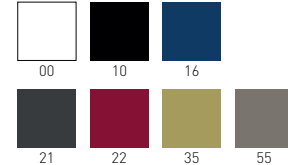

SURFY DESK 2027



Frame colors / Colori struttura

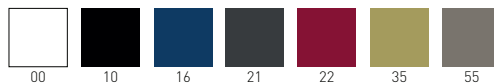

Option: Cod. 1101
Cable Routing Option,
anodized Aluminum 8x8 cm,
black brush
Opzione Passacavi,
Alluminio anodizzato 8x8 cm
spazzolina nera
DKK 750

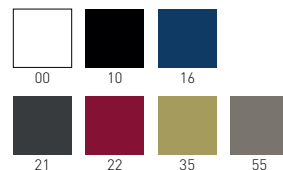

Option: Cod. ACCV030...
Metal Fairlead Solution
Tubo metallico passacavi
DKK 475

Colors / Colori

Laminated Top Color / Colore Piano Laminato

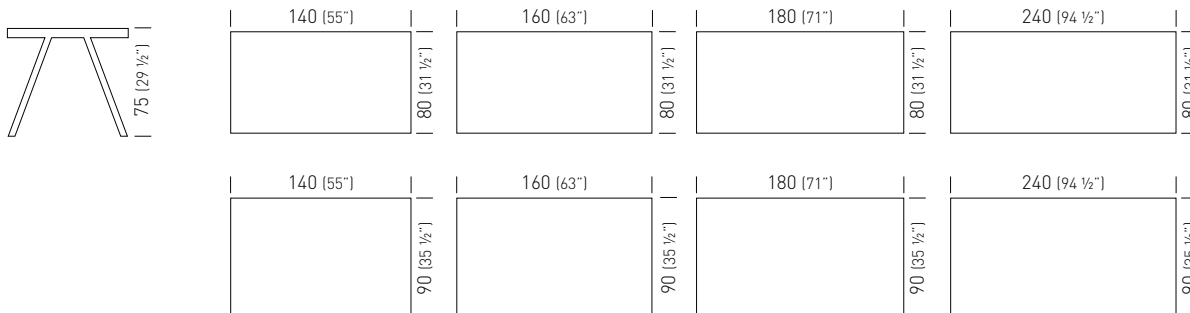
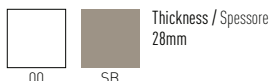

Desk Size	Model	Volume	Weight	Quantity	DKK - kr
80x140laminated	TSRDL300._._/H74	0.41m³	32kg	1pcs	6.795
80x160laminated	TSRDL320._._/H74	0.51m³	35kg	1pcs	7.895
80x180laminated	TSRDL301._._/H74	0.60m³	38kg	1pcs	8.295
80x240laminated	TSRDL302._._/H74	0.90m³	46.5kg	1pcs	10.595
90x140laminated	TSRDL303._._/H74	0.65m³	34kg	1pcs	8.095
90x160laminated	TSRDL321._._/H74	0.73m³	37kg	1pcs	8.795
90x180laminated	TSRDL304._._/H74	0.80m³	40kg	1pcs	9.195
90x240laminated	TSRDL305._._/H74	1.0m³	50kg	1pcs	11.895

Laminated Top Color / Colore Piano Laminato

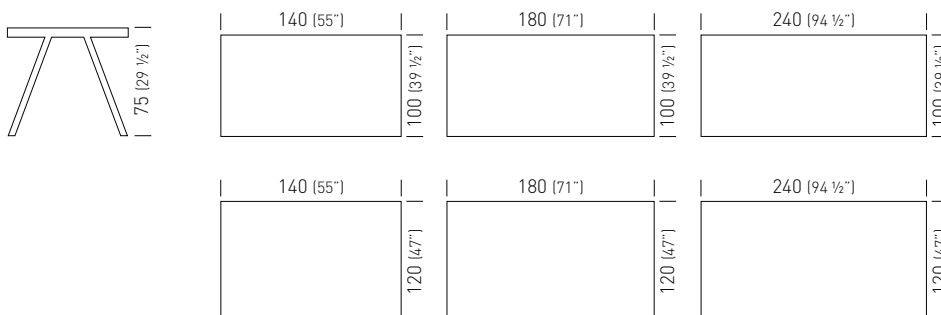

Option: Cod. 1101
Cable Routing Option,
anodized Aluminum 8x8 cm,
black brush
Opzione Passacavi,
Alluminio anodizzato 8x8 cm
spazzolina nera
DKK 750



Option: Cod. ACCV030...
Metal Fairlead Solution
Tubo metallico passacavi
DKK 475

Colors / Colori

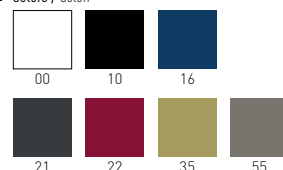

Desk Size	Model	Volume	Weight	Quantity	DKK - kr
100x140laminated	TSRDL306._._/H74	0.70m³	40.5kg	1pcs	8.795
100x180laminated	TSRDL307._._/H74	0.85m³	49kg	1pcs	9.895
100x240laminated	TSRDL308._._/H74	1.1m³	62kg	1pcs	13.095
120x140laminated	TSRDL309._._/H74	0.8m³	46kg	1pcs	10.095
120x180laminated	TSRDL310._._/H74	1.0m³	56kg	1pcs	11.495
120x240laminated	TSRDL311._._/H74	1.3m³	72kg	1pcs	15.095

SURFY DESK BRIDGE 2027



Frame colors / Colori struttura

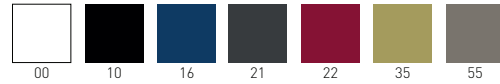

Laminated Top Color / Colore Piano Laminato

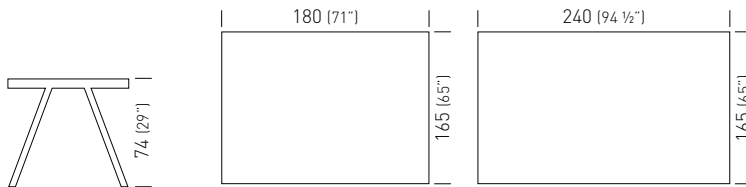
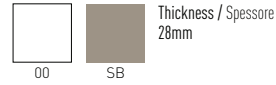

Option: Cod. 1101
Cable Routing Option,
anodized Aluminum 8x8 cm,
black brush
Opzione Passacavi,
Alluminio anodizzato 8x8 cm
spazzolina nera
DKK 750



Option: Cod. ACCV030...
Metal Fairlead Solution
Tubo metallico passacavi
DKK 475

165x180laminated TSRDL314.__-_/H74 0.90m³ / 87kg / 1pcs DKK - kr
165x240laminated TSRDL316.__-_/H74 1.20m³ / 109kg / 1pcs

17.195
20.195

Table Extension / Modulo Aggiuntivo
165x180laminated TSRDL315.__-_/H74 0.40m³ / 77kg / 1pcs
165x240laminated TSRDL317.__-_/H74 0.50m³ / 99kg / 1pcs

14.095
16.295

Colors / Colori

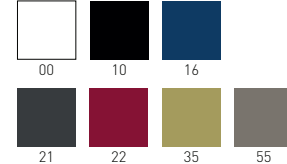

SURFY HIGH DESK 2027



Frame colors / Colori struttura

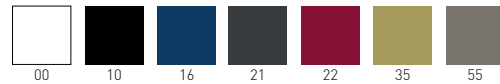

Laminated Top Color / Colore Piano Laminato

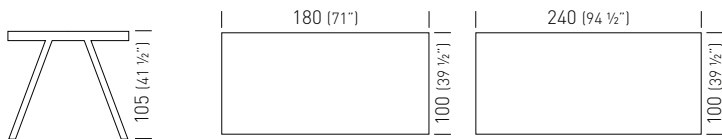
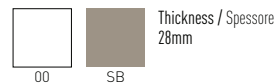

Option: Cod. 1101
Cable Routing Option,
anodized Aluminum 8x8 cm,
black brush
Opzione Passacavi,
Alluminio anodizzato 8x8 cm
spazzolina nera
DKK 750

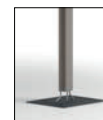

Option: Cod. ACCV030...
Metal Fairlead Solution
Tubo metallico passacavi
DKK 475

100x180laminated TSRDL307.__-_/H105 0.85m³ / 57kg / 1pcs DKK - kr
100x240laminated TSRDL308.__-_/H105 1.10m³ / 69kg / 1pcs

12.195
14.695

Colors / Colori

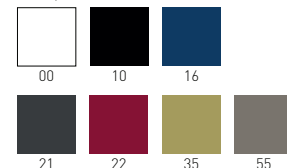

SURFY DESK 2027 L VERSION



Frame colors / Colori struttura



Laminated Top Color / Colore Piano Laminato

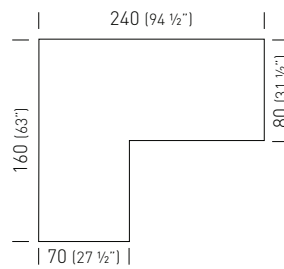
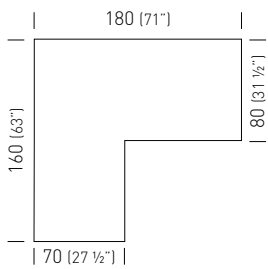
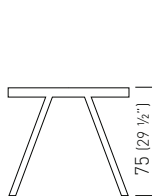
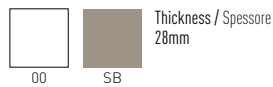

80x180laminated
80x240laminated

TSRDL330.__-__ / H75
TSRDL331.__-__ / H75

0.65m³ / 53kg / 1pc
 0.95m³ / 61.5kg / 1pc

DKK - kr

11.095
13.395



Option: Cod. 1101
Cable Routing Option,
anodized Aluminum 8x8 cm,
black brush
Opzione Passacavi,
Alluminio anodizzato 8x8 cm
spazzolina nera
DKK 750



Option: Cod. ACCV030.___
Metal Fairlead Solution
Tubo metallico passacavi
DKK 475

Colors / Colori

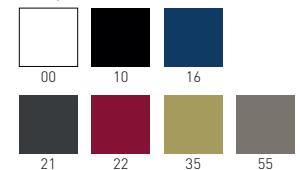

Surfy Outdoor 2027 Coffee Table

Studio Eurolinea Design

Waiting areas and Coffee Table, Compactop with
three metal legs frame.

Tavolino attesa con piano in Compactop e
struttura a tre gambe in metallo.



Frame colors / Colori struttura

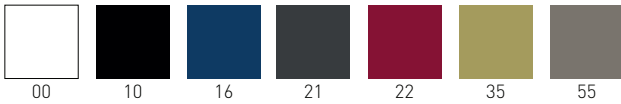

Compactop Color / Colore Piano Compactop

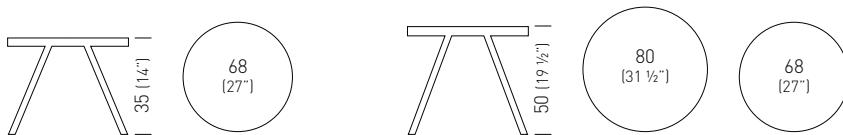
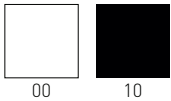

			DKK - kr
diam.68 compactop	TSROC278.___/H35	0.15m ³ / 11kg / 1pc	2.895
diam.68 fullcolor (min 5pcs)	TSROC279.___/H35	0.15m ³ / 11kg / 1pc	3.095
diam.68 compactop	TSROC278.___/H50	0.15m ³ / 11.50kg / 1pc	2.895
diam.68 fullcolor (min 5pcs)	TSROC279.___/H50	0.15m ³ / 11.50kg / 1pc	3.195
diam.80 compactop	TSROC297.___/H50	0.18m ³ / 14kg / 1pc	3.195
diam.80 fullcolor (min 5pcs)	TSROC298.___/H50	0.18m ³ / 14kg / 1pc	3.595

Surfy Hub 2027 Coffee Table

Studio Eurolinea Design

Waiting areas and Coffee Table, Laminated
Table Top with four metal legs frame.

Tavolino attesa con piano in Laminato e struttura
a 4 gambe in metallo.



Frame colors / Colori struttura



Laminated Top Color / Colore Piano Laminato

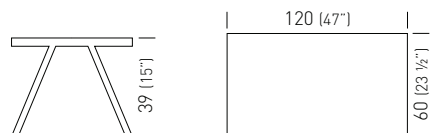
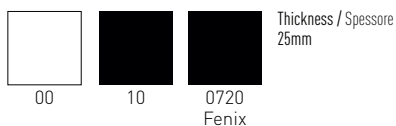

60x120 laminated
60x120 lam.fenix

TSRHL256.___/H39
TSRHL256.0720-_/H39

0.65m³ / 22Kg / 1pc
 0.65m³ / 22Kg / 1pc

DKK - kr

5.395
5.995

Tag Marble

Ilaria Marelli Design



The Marble tops, characterized by always different veins of natural stones, contribute to enhance elegance and refinement for the most demanding environments. The solid Marble surfaces, shiny and glossy, are treated to reduce their porosity, however constant care and cleaning of the product is recommended.

I piani in Marmo, caratterizzati dalle sempre diverse venature della pietra naturale, offrono eleganza e raffinatezza, per completare con esclusività gli ambienti più ricercati. I solidi piani in Marmo, splendenti e lucidi, sono trattati per ridurre la porosità, tuttavia si consiglia pulizia costante e cura nell'utilizzo del prodotto.

Frame Color / Colore Struttura

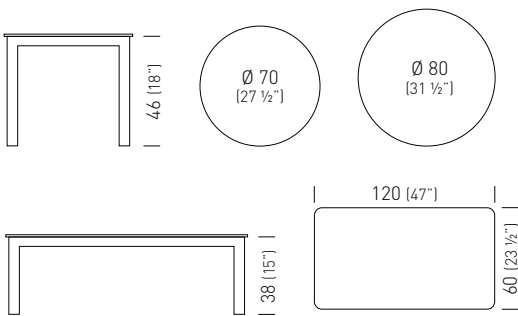
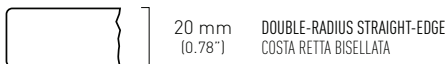
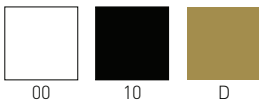

diam. 70
diam. 80
60x120

TTAGM403._-_/H45
TTAGM404._-_/H45
TTAGM405._-_/H37

0.55m³ / 25kg / 1pc
0.55m³ / 31kg / 1pc
0.50m³ / 42kg / 1pc

DKK - kr

6.195
6.995
8.995

Tag Porcelain

Ilaria Marelli Design

The Porcelain stoneware tops stand out for their excellent technical performance, ideal for the most delicate uses where maximum hygiene and resistance must be guaranteed. Porcelain tops are compatible with foodstuffs, resistant to fungi and molds, suitable for both indoor and outdoor use, resistant to frost, heat and high temperatures, they can be cleaned very easily while maintaining the characteristics of the surface.

I piani in Gres Porcellanato si distinguono per le eccellenti performance tecniche, ideali negli impieghi più delicati nei quali è necessario garantire la massima igiene e resistenza. I piani Porcelain sono compatibili con le sostanze alimentari, resistenti a funghi e muffe, idonei ad un utilizzo sia interno che esterno, resistenti al gelo, al calore a alle alte temperature, si possono pulire con estrema facilità mantenendo inalterate le caratteristiche della superficie.



Frame Color / Colore Struttura

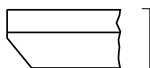
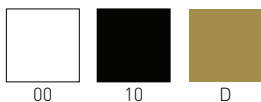

13 mm
(0.51")
CHAMFERED EDGE
BORDO SMUSSATO



PCO
CALACATTA ORO



PNG
NERO GRECO

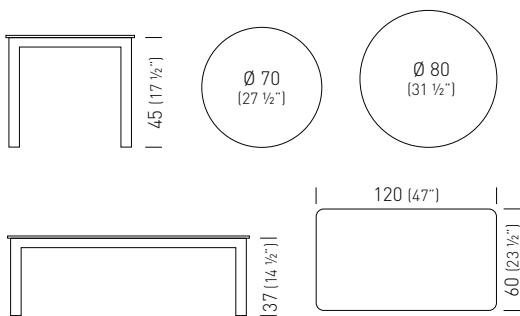

diam. 70
diam. 80
60x120

TTAGP407. __-_/H45  0.55m³ / 27kg / 1pc
TTAGP408. __-_/H45  0.55m³ / 31.5kg / 1pc
TTAGP409. __-_/H37  0.50m³ / 40kg / 1pc

DKK - kr

6.895
7.695
7.795

Min. order 10pcs
each code
Ordine min 10pz
per codice

Together

Mark Sadler Design



Natural Oak wood table top and polycarbonate legs:
transparent, solid white, solid black.
Tavolo con piano in legno di rovere,
gambe in policarbonato trasparente, bianche o nere.

Technopolymer Frame Color / Colore Struttura Tecnopolimero

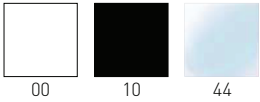

Top Color / Colore Piano

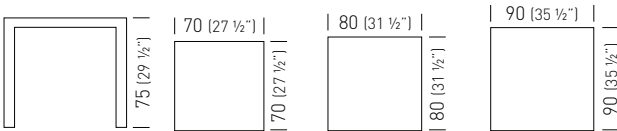

70x70
80x80
90x90

TTOGL420._._/H75
TTOGL422._._/H75
TTOGL424._._/H75

0.40m³ / 16kg / 1pcs
 0.40m³ / 18kg / 1pcs
 0.40m³ / 20kg / 1pcs

DKK - kr

6.895
7.195
7.495

Together

Mark Sadler Design

Together is a solid and versatile table, suitable to be utilized with elegance in all modern environments. The legs, made of natural solid oak, are combined with a natural oak veneered top, thus obtaining a pleasant visual play of solid interlocking between the leg and the top. With a simple and elegant design, Together adapts to any decorative context, expressing the warmth of wood and its small details. The legs are always at the extreme of tops sizes. Together è un tavolo solido e versatile, adatto ad essere inserito con eleganza in tutti gli ambienti moderni. Le gambe, realizzate in rovere massello naturale, sono abbinata ad un piano impiallacciato rovere naturale, ottenendo così un piacevole gioco visivo di solido incastro tra la gamba e il piano. Dal design semplice ed elegante, Together si adatta a qualunque contesto decorativo esprimendo il calore del legno ed i suoi piccoli dettagli. Le gambe restano sempre all' estremo.



Wooden Frame Color / Colore Struttura Legno Top Color / Colore Piano



RN



RN

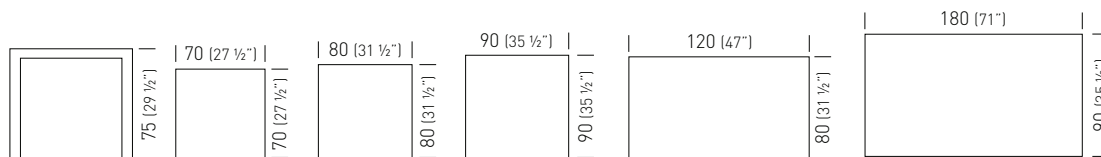

70x70	TTOGL420._._/H75	0.40m³ / 16kg / 1pcs	DKK - kr	6.895
80x80	TTOGL422._._/H75	0.40m³ / 18kg / 1pcs		7.195
90x90	TTOGL424._._/H75	0.40m³ / 20kg / 1pcs		7.495
120x80	TTOGL426._._/H75	0.48m³ / 24kg / 1pcs		11.195
180x90	TTOGL428._._/H75	0.80m³ / 33kg / 1pcs		16.195

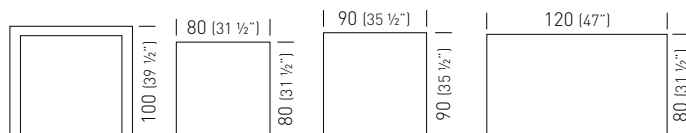

80x80	TTOGL422._._/H100	0.42m³ / 22kg / 1pcs	DKK - kr	8.095
90x90	TTOGL424._._/H100	0.42m³ / 24kg / 1pcs		8.395
120x80	TTOGL426._._/H100	0.50m³ / 27kg / 1pcs		12.295

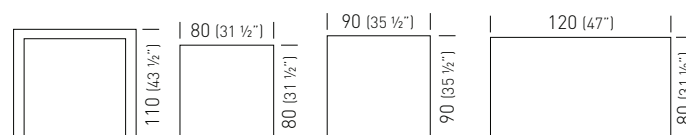

80x80	TTOGL422._._/H110	0.42m³ / 22kg / 1pcs	DKK - kr	8.495
90x90	TTOGL424._._/H110	0.42m³ / 24kg / 1pcs		8.695
120x80	TTOGL426._._/H110	0.50m³ / 27kg / 1pcs		12.395

Woody

Favaretto & Partners Design

Waiting areas and Coffee Table,
double Compactop deck and beech legs.
Tavolino attesa con doppio piano Compactop
e gambe in legno di faggio.



Wooden Frame Color / Colore Struttura Legno



F

Top Color / Colore Piano



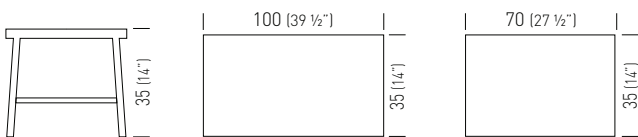

00

Fullcolor



100x35
70x35

TWOOC132.00-F/H35
TWOOC130.00-F/H35

 0.18m³ / 12kg / 1pcs
 0.13m³ / 9kg / 1pcs

DKK - kr

2.895
2.595

TKITT Collection

TABLES FOR INDOOR AND OUT



TKITT.BG3K

H75 Table with technopolymer top, BG3K 3-spur metal-technopolymer co-injected table base, Ø 80mm anodized aluminum column.

Tavolo con piano in tecnopolimero H75, basamento BG3K a tre razze in metallo sovrastampato con tecnopolimero, colonna in alluminio anodizzato Ø 80mm.

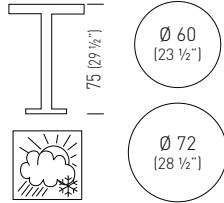

■ TKITT04._/BG3K
■ TKITT04._/BG3K.10

0.13m³ / 13.8kg / 1pcs
0.13m³ / 13.8kg / 1pcs

DKK - kr

1.895
1.995

■ TKITT03._/BG3K
■ TKITT03._/BG3K.10

0.15m³ / 14.5kg / 1pcs
0.15m³ / 14.5kg / 1pcs

2.095
2.195

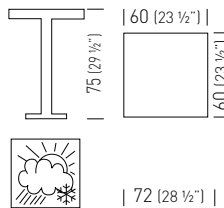

■ TKITT20._/BG3K
■ TKITT20._/BG3K.10

0.13m³ / 14.6kg / 1pcs
0.13m³ / 14.6kg / 1pcs

1.895
2.095

■ TKITT06._/BG3K
■ TKITT06._/BG3K.10

0.15m³ / 15.8kg / 1pcs
0.15m³ / 15.8kg / 1pcs

2.195
2.395

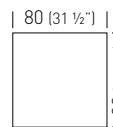

■ TKITT23._/BG3K
■ TKITT23._/BG3K.10

0.16m³ / 18.4kg / 1pcs
0.16m³ / 18.4kg / 1pcs

2.295
2.495

Top Color / Colore Piano

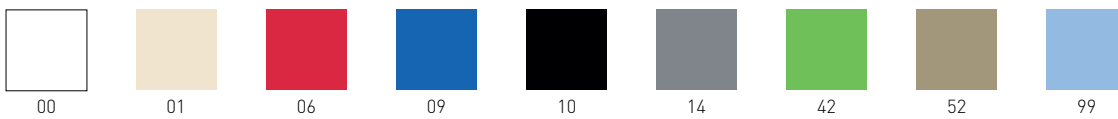

TKITT.BG3L

H75 Table with technopolymer top, BG3L 3-spur metal-technopolymer co-injected table base, Ø 80mm anodized aluminum column.

Tavolo con piano in tecnopolimero H75, basamento BG3L a tre razze in metallo sovrastampato con tecnopolimero, colonna in alluminio anodizzato Ø 80mm.

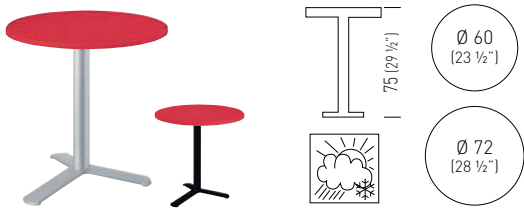

■ TKITT04._/BG3L		0.14m³ / 15kg / 1pcs	DKK - kr	1.895
■ TKITT04._/BG3L.10		0.14m³ / 15kg / 1pcs		1.995

■ TKITT03._/BG3L		0.16m³ / 15.7kg / 1pcs		2.095
■ TKITT03._/BG3L.10		0.16m³ / 15.7kg / 1pcs		2.195

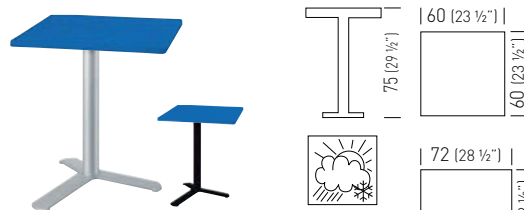

■ TKITT20._/BG3L		0.14m³ / 15.8kg / 1pcs		1.995
■ TKITT20._/BG3L.10		0.14m³ / 15.8kg / 1pcs		2.095

■ TKITT06._/BG3L		0.16m³ / 17kg / 1pcs		2.195
■ TKITT06._/BG3L.10		0.16m³ / 17kg / 1pcs		2.395

■ TKITT23._/BG3L		0.17m³ / 19.6kg / 1pcs		2.395
■ TKITT23._/BG3L.10		0.17m³ / 19.6kg / 1pcs		2.495

TKITT.BGA3L

H110 Table with technopolymer top, BG3L 3-spur metal-technopolymer co-injected table base, Ø 80mm anodized aluminum column.

Tavolo con piano in tecnopolimero H110, basamento BG3L a tre razze in metallo sovrastampato con tecnopolimero, colonna in alluminio anodizzato Ø 80mm.

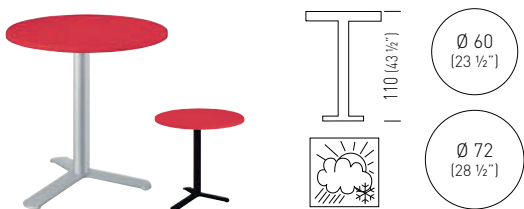

■ TKITT04._/BGA3L		0.18m³ / 15.8kg / 1pcs	DKK - kr	2.095
■ TKITT04._/BGA3L.10		0.18m³ / 15.8kg / 1pcs		2.295

■ TKITT03._/BGA3L		0.20m³ / 16.5kg / 1pcs		2.295
■ TKITT03._/BGA3L.10		0.20m³ / 16.5kg / 1pcs		2.495

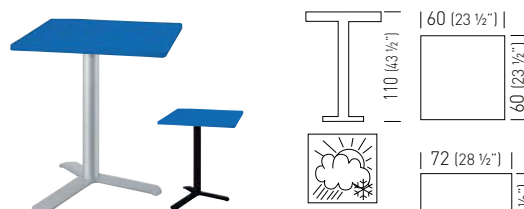

■ TKITT20._/BGA3L		0.18m³ / 16.6kg / 1pcs		2.195
■ TKITT20._/BGA3L.10		0.18m³ / 16.6kg / 1pcs		2.395

■ TKITT06._/BGA3L		0.20m³ / 17.8kg / 1pcs		2.195
■ TKITT06._/BGA3L.10		0.20m³ / 17.8kg / 1pcs		2.395

Top Color / Colore Piano

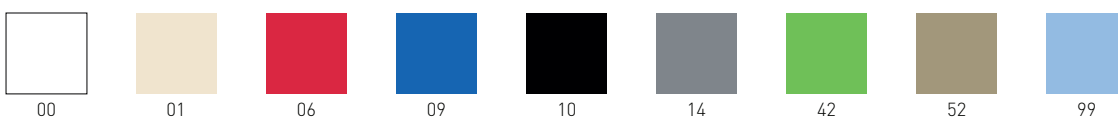

TKITT.BG4K

H75 Table with technopolymer top, BG4K 4-spur metal-technopolymer co-injected table base, Ø 80mm anodized aluminum column.

Tavolo con piano in tecnopolimero H75, basamento BG4K a quattro razze in metallo sovrastampato con tecnopolimero, colonna in alluminio anodizzato Ø 80mm.

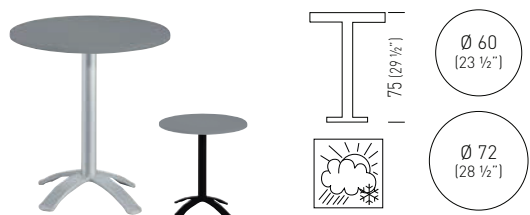

■ TKITT04._/BG4K		0.13m³ / 16.5kg / 1pcs	DKK - kr	1.895
■ TKITT04._/BG4K.10		0.13m³ / 16.5kg / 1pcs		2.095

■ TKITT03._/BG4K		0.15m³ / 17.2kg / 1pcs		2.095
■ TKITT03._/BG4K.10		0.15m³ / 17.2kg / 1pcs		2.295

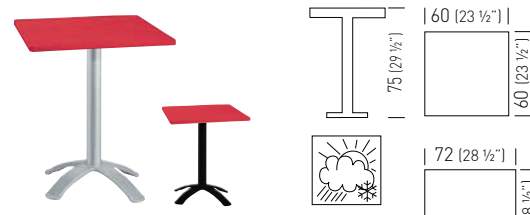

■ TKITT20._/BG4K		0.13m³ / 17.3kg / 1pcs		1.995
■ TKITT20._/BG4K.10		0.13m³ / 17.3kg / 1pcs		2.195

■ TKITT06._/BG4K		0.15m³ / 18.5kg / 1pcs		2.295
■ TKITT06._/BG4K.10		0.15m³ / 18.5kg / 1pcs		2.495

■ TKITT23._/BG4K		0.16m³ / 21.1kg / 1pcs		2.395
■ TKITT23._/BG4K.10		0.16m³ / 21.1kg / 1pcs		2.595

TKITT.BGA4K

H115 Table with technopolymer top, BG4K 4-spur metal-technopolymer co-injected table base, Ø 80mm anodized aluminum column.

Tavolo con piano in tecnopolimero H115, basamento BG4K a quattro razze in metallo sovrastampato con tecnopolimero, colonna in alluminio anodizzato Ø 80mm.

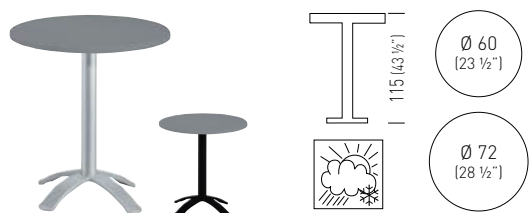

■ TKITT04._/BGA4K		0.17m³ / 17.3kg / 1pcs	DKK - kr	2.595
■ TKITT04._/BGA4K.10		0.17m³ / 17.3kg / 1pcs		2.795

■ TKITT03._/BGA4K		0.19m³ / 18kg / 1pcs		2.695
■ TKITT03._/BGA4K.10		0.19m³ / 18kg / 1pcs		2.995

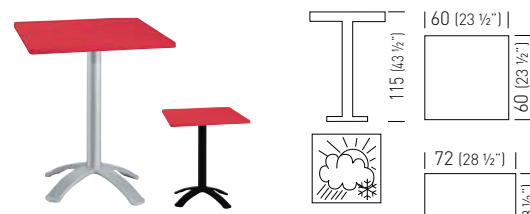

■ TKITT20._/BGA4K		0.17m³ / 18.1kg / 1pcs		2.595
■ TKITT20._/BGA4K.10		0.17m³ / 18.1kg / 1pcs		2.895

■ TKITT06._/BGA4K		0.19m³ / 19.3kg / 1pcs		2.895
■ TKITT06._/BGA4K.10		0.19m³ / 19.3kg / 1pcs		3.195

Top Color / Colore Piano



TKITT.BG4J

H73 Table with technopolymer top, BG4J 4-spur metal-technopolymer co-injected table base, 80x80mm anodized aluminum column.

Tavolo con piano in tecnopolimero H73, basamento BG4J a quattro razze in metallo sovrastampato con tecnopolimero, colonna in alluminio anodizzato 80x80mm.

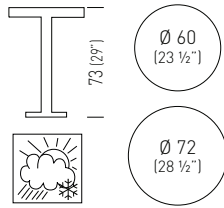

■ TKITT04._/BG4J		0.16m ³ / 16.8kg / 1pcs	DKK - kr	2.095
■ TKITT04._/BG4J.10		0.16m ³ / 16.8kg / 1pcs		2.295

■ TKITT03._/BG4J		0.18m ³ / 17.5kg / 1pcs		2.295
■ TKITT03._/BG4J.10		0.18m ³ / 17.5kg / 1pcs		2.495

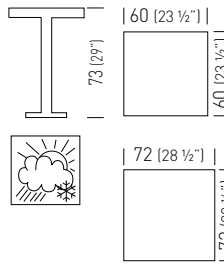

■ TKITT20._/BG4J		0.16m ³ / 17.6kg / 1pcs		2.195
■ TKITT20._/BG4J.10		0.16m ³ / 17.6kg / 1pcs		2.395

■ TKITT06._/BG4J		0.18m ³ / 18.8kg / 1pcs		2.495
■ TKITT06._/BG4J.10		0.18m ³ / 18.8kg / 1pcs		2.595

■ TKITT23._/BG4J		0.19m ³ / 21.4kg / 1pcs		2.595
■ TKITT23._/BG4J.10		0.19m ³ / 21.4kg / 1pcs		2.795

TKITT.BGPK

H75 folding table with technopolymer top, BG4J 4-spur metal-technopolymer co-injected base, Ø 80mm anodized aluminum column with flip-top mechanism.

Tavolo pieghevole con piano in tecnopolimero H75, basamento BGPK a quattro razze in metallo sovrastampato con tecnopolimero, colonna in alluminio anodizzato Ø 80mm.

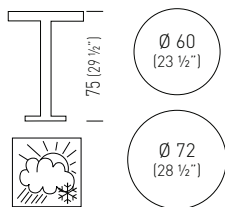

■ TKITT04._/BGPK		0.13m ³ / 17.5kg / 1pcs	DKK - kr	2.695
■ TKITT04._/BGPK.10		0.13m ³ / 17.5kg / 1pcs		2.895

■ TKITT03._/BGPK		0.15m ³ / 18.2kg / 1pcs		2.895
■ TKITT03._/BGPK.10		0.15m ³ / 18.2kg / 1pcs		3.095

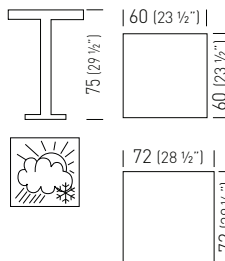

■ TKITT20._/BGPK		0.13m ³ / 18.3kg / 1pcs		2.795
■ TKITT20._/BGPK.10		0.13m ³ / 18.3kg / 1pcs		2.995

■ TKITT06._/BGPK		0.15m ³ / 19.5kg / 1pcs		2.995
■ TKITT06._/BGPK.10		0.15m ³ / 19.5kg / 1pcs		3.295

■ TKITT23._/BGPK		0.16m ³ / 22.1kg / 1pcs		3.095
■ TKITT23._/BGPK.10		0.16m ³ / 22.1kg / 1pcs		3.395

Top Color / Colore Piano

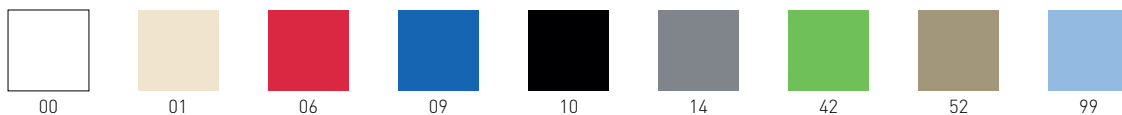

TKITT.BGPJ

H75 folding table with technopolymer top, BG4J 4-spur metal-technopolymer co-injected base, 80x80mm anodized aluminum column with flip-top mechanism.

Tavolo pieghevole con piano in tecnopolimero H75, basamento BGPJ a quattro razze in metallo sovrastampato con tecnopolimero, colonna in alluminio anodizzato 80x80mm.

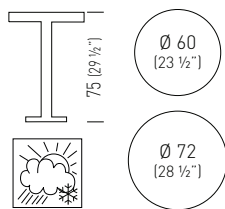

- TKITT04._/BGPJ
- TKITT04._/BGPJ.10

- 0.16m³ / 17.8kg / 1pcs
- 0.16m³ / 17.8kg / 1pcs

DKK - kr

2.795
3.095

- TKITT03._/BGPJ
- TKITT03._/BGPJ.10

- 0.18m³ / 18.5kg / 1pcs
- 0.18m³ / 18.5kg / 1pcs

2.995
3.295

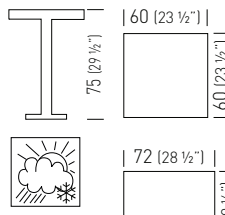

- TKITT20._/BGPJ
- TKITT20._/BGPJ.10

- 0.16m³ / 18.6kg / 1pcs
- 0.16m³ / 18.6kg / 1pcs

2.895
3.195

- TKITT06._/BGPJ
- TKITT06._/BGPJ.10

- 0.18m³ / 19.8kg / 1pcs
- 0.18m³ / 19.8kg / 1pcs

3.195
3.495

- TKITT23._/BGPJ
- TKITT23._/BGPJ.10

- 0.19m³ / 22.4kg / 1pcs
- 0.19m³ / 22.4kg / 1pcs

3.295
3.595

TKITT.BG4IP

Folding and stacking H75 table with technopolymer top, BG4IP 4-spur metal-technopolymer co-injected table base, Ø 80mm anodized aluminum column with flip-top mechanism and adjustable feet.

Tavolo pieghevole e accatastabile con piano in tecnopolimero H75, basamento BG4IP a quattro razze in metallo sovrastampato con tecnopolimero, colonna in alluminio anodizzato Ø 80mm e piedini regolabili.

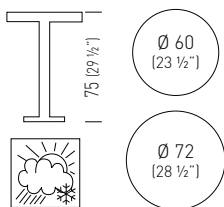

- TKITT04._/BG4IP
- TKITT04._/BG4IP.10

- 0.13m³ / 14kg / 1pcs
- 0.13m³ / 14kg / 1pcs

DKK - kr

2.995
3.295

- TKITT03._/BG4IP
- TKITT03._/BG4IP.10

- 0.15m³ / 14.7kg / 1pcs
- 0.15m³ / 14.7kg / 1pcs

3.295
3.495

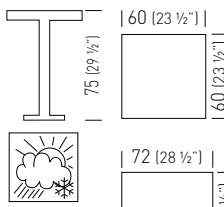

- TKITT20._/BG4IP
- TKITT20._/BG4IP.10

- 0.13m³ / 14.8kg / 1pcs
- 0.13m³ / 14.8kg / 1pcs

3.095
3.395

- TKITT06._/BG4IP
- TKITT06._/BG4IP.10

- 0.15m³ / 16kg / 1pcs
- 0.15m³ / 16kg / 1pcs

3.395
3.695

- TKITT23._/BG4IP
- TKITT23._/BG4IP.10

- 0.16m³ / 18.5kg / 1pcs
- 0.16m³ / 18.5kg / 1pcs

3.495
3.795

Top Color / Colore Piano

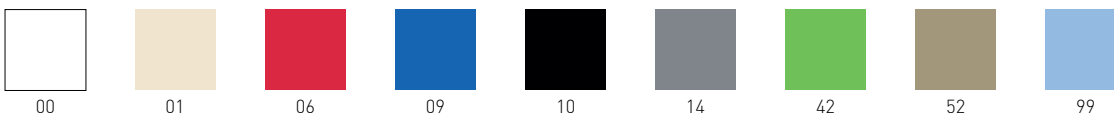

TKITT.BTK

H75 Table with technopolymer top, round BTK metal-technopolymer co-injected base, Ø 80mm anodized aluminum column.

Tavolo con piano in tecnopolimero H75, basamento BTK rotondo in metallo sovrastampato con tecnopolimero, colonna in alluminio anodizzato Ø 80mm.

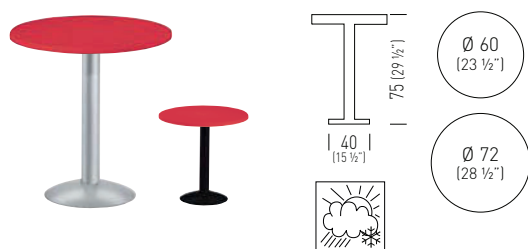

■ TKITT04._/BTK	0.16m³ / 13.8kg / 1pcs	DKK - kr	1.795
■ TKITT04._/BTK.10	0.16m³ / 13.8kg / 1pcs		1.895
■ TKITT03._/BTK	0.18m³ / 14.5kg / 1pcs		1.995
■ TKITT03._/BTK.10	0.18m³ / 14.5kg / 1pcs		2.095

TKITT.BTAK

H110 Table with technopolymer top, round BTAK metal-technopolymer co-injected base, Ø 80mm anodized aluminum column.

Tavolo con piano in tecnopolimero H110, basamento BTAK rotondo in metallo sovrastampato con tecnopolimero, colonna in alluminio anodizzato Ø 80mm.

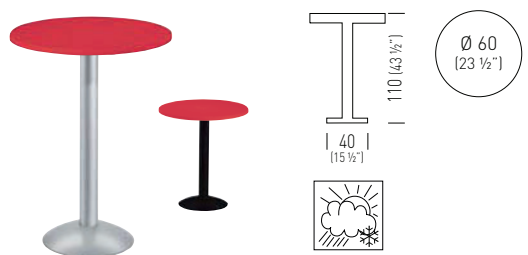

■ TKITT04._/BTAK	0.17m³ / 14.8kg / 1pcs	DKK - kr	2.095
■ TKITT04._/BTAK.10	0.17m³ / 14.8kg / 1pcs		2.295

Top Color / Colore Piano

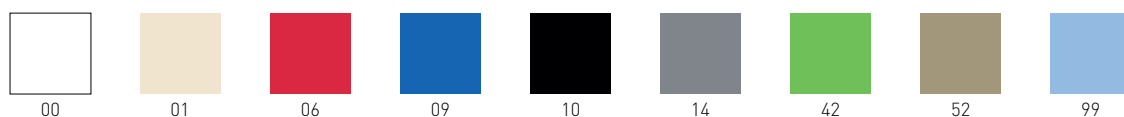

TKITT.BTK54

H75 Table with technopolymer top, round BTK54 metal-technopolymer co-injected table base, Ø 80mm anodized aluminum column.

Tavolo con piano in tecnopolimero H75, basamento BTK54 rotondo in metallo sovrastampato con tecnopolimero, colonna in alluminio anodizzato Ø 80mm.

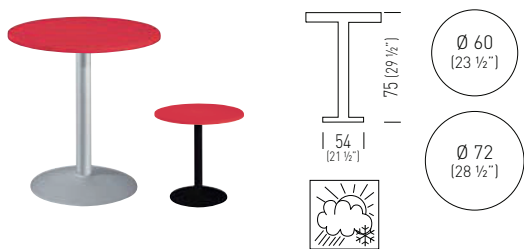

■ TKITT04._/BTK54		0.16m³ / 16.3kg / 1pcs	DKK - kr	1.895
■ TKITT04._/BTK54.10		0.16m³ / 16.3kg / 1pcs		2.095
■ TKITT03._/BTK54		0.18m³ / 17kg / 1pcs		2.095
■ TKITT03._/BTK54.10		0.18m³ / 17kg / 1pcs		2.295

TKITT.BTAK54

H110 Table with technopolymer top, round BTK54 metal-technopolymer co-injected table base, Ø 80mm anodized aluminum column.

Tavolo con piano in tecnopolimero H110, basamento BTAK54 rotondo in metallo sovrastampato con tecnopolimero, colonna in alluminio anodizzato Ø 80mm.

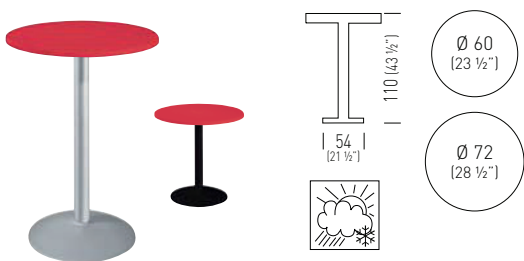

■ TKITT04._/BTAK54		0.17m³ / 17.3kg / 1pcs	DKK - kr	2.295
■ TKITT04._/BTAK54.10		0.17m³ / 17.3kg / 1pcs		2.495
■ TKITT03._/BTAK54		0.19m³ / 18kg / 1pcs		2.495
■ TKITT03._/BTAK54.10		0.19m³ / 18kg / 1pcs		2.695

Top Color / Colore Piano

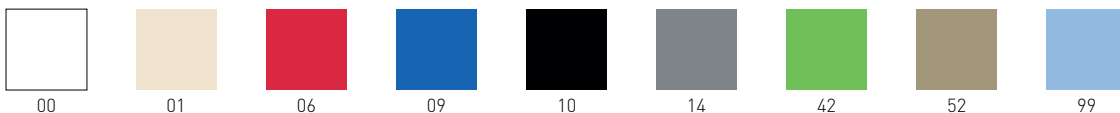

TKITT.DPBT54

H110 double table with technopolymer tops, round DPBT54 metal-technopolymer co-injected base, Ø 80mm anodized aluminum column.

Tavolo con doppio piano in tecnopolimero H110, basamento DPBT54 rotondo in metallo sovrastampato con tecnopolimero, colonna in alluminio anodizzato Ø 80mm.

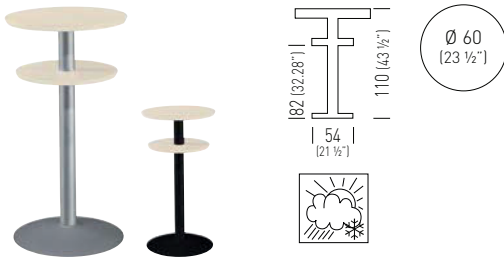

■ TKITT08._/DPBT54	 0.15m ³ / 16.5kg / 1pcs
■ TKITT08._/DPBT54.10	 0.15m ³ / 16.5kg / 1pcs

DKK - kr

2.595
2.895

TKITT.BRK

H75 Table with technopolymer top, round BRK metal-technopolymer co-injected base, Ø 80mm anodized aluminum column.

Tavolo con piano in tecnopolimero H75, basamento BRK rotondo in metallo sovrastampato con tecnopolimero, colonna in alluminio anodizzato Ø 80mm.

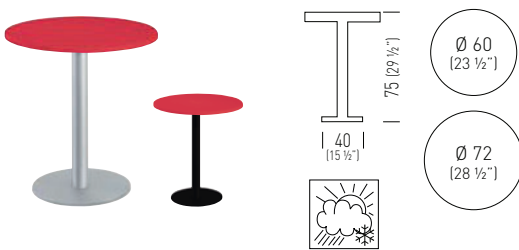

■ TKITT04._/BRK	 0.13m ³ / 14.3kg / 1pcs
■ TKITT04._/BRK.10	 0.13m ³ / 14.3kg / 1pcs

DKK - kr

1.695
1.795

■ TKITT03._/BRK	 0.15m ³ / 15kg / 1pcs
■ TKITT03._/BRK.10	 0.15m ³ / 15kg / 1pcs

1.895
2.095

Top Color / Colore Piano

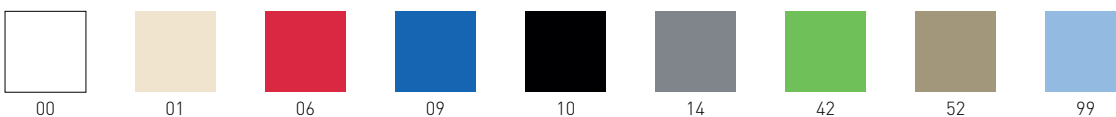

TKITT.BQJ

H74 Table with technopolymer top, square BQJ metal-technopolymer co-injected table base, 80x80mm anodized aluminum column.

Tavolo con piano in tecnopolimero H74, basamento BQJ quadrato in metallo sovrastampato con tecnopolimero, colonna in alluminio anodizzato 80x80mm.

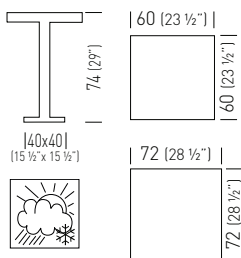

- TKITT20._/BQJ
- TKITT20._/BQJ.10

- 0.13m³ / 17.1kg / 1pcs
- 0.13m³ / 17.1kg / 1pcs

DKK - kr

1.895
1.995

- TKITT06._/BQJ
- TKITT06._/BQJ.10

- 0.15m³ / 18.3kg / 1pcs
- 0.15m³ / 18.3kg / 1pcs

2.195
2.295

TKITT.BQAJ

H103 Table with technopolymer top, square BQJ metal-technopolymer co-injected table base, 80x80mm anodized aluminum column.

Tavolo con piano in tecnopolimero H103, basamento BQJ quadrato in metallo sovrastampato con tecnopolimero, colonna in alluminio anodizzato 80x80mm.

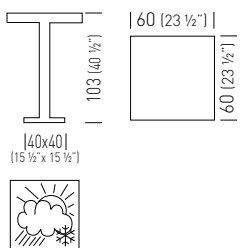

- TKITT20._/BQAJ
- TKITT20._/BQAJ.10

- 0.14m³ / 17.6kg / 1pcs
- 0.14m³ / 17.6kg / 1pcs

DKK - kr

2.295
2.495

Top Color / Colore Piano

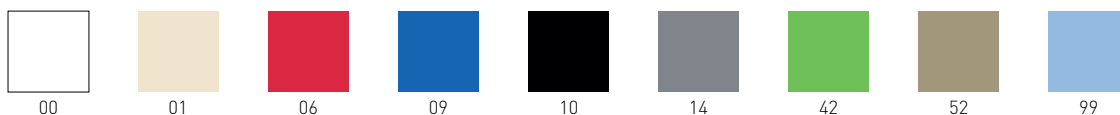

TIMPT.STAKY

Stackable table collection, suitable for outdoor use.
Techno polymer tops and anodized aluminum frames.

Collezione di tavoli impilabili, adatti all'uso esterno.
I tavoli sono realizzati con piani in tecnopolimero e struttura in alluminio anodizzato.

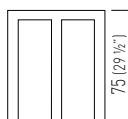

TIMPT04._/H75

0.08m³ / 7.1kg / 1pcs

DKK - kr

1.295



TIMPT03._/H75

0.08m³ / 7.3kg / 1pcs

1.395

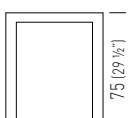

TIMPT20._/H75

0.05m³ / 7.6kg / 1pcs

DKK - kr

1.495



TIMPT23._/H75

0.09m³ / 8kg / 1pcs

1.795

Top Color / Colore Piano



00



01



06



09



10



14



42



52



99

TCONT.STEADY

Counterbalanced tables collection, suitable for outdoor use.
Techno polymer tops and anodized aluminum frames.

Collezione di tavoli a contrappesi, adatti all'uso esterno.
I tavoli sono realizzati con piani in tecnopolimero e struttura
in alluminio anodizzato.

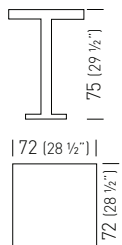

TCONT06._/H75

 0.08m³ / 12.8kg / 1pcs DKK - kr

1.795

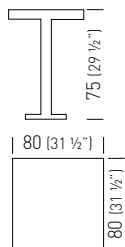

TCONT23._/H75

 0.10m³ / 13kg / 1pcs

1.995

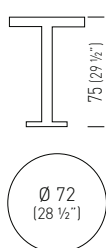

TCONT03._/H75

 0.08m³ / 12.6kg / 1pcs

1.695

Top Color / Colore Piano



00



01



06



09



10



14



42



52



99

Standard Compactop Surfaces



Flat black edge
Bordo piatto nero

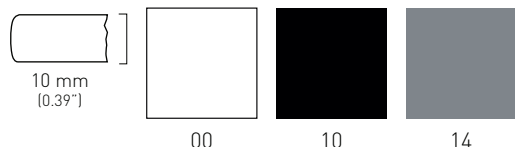

Flat black edge
Bordo piatto nero

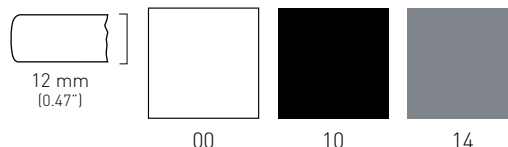

Sizes / Misure	Code / Codice		DKK - kr
Ø 60 (23 1/2")	PTC101._	0.054m³ / 11kg / 2pcs	1.195
Ø 68 (27")	PTC103._	0.074m³ / 13kg / 2pcs	1.495
59x59 (23"x23")	PTC102._	0.054m³ / 12kg / 2pcs	995
68x68 (27"x27")	PTC104._	0.074m³ / 19kg / 2pcs	1.195
79x79 (31"x31")	PTC106._	0.090m³ / 20kg / 2pcs	1.395
89x89 (35"x35")	PTC107._	0.11m³ / 25kg / 2pcs	1.795

Sizes / Misure	Code / Codice		DKK - kr
Ø 80 (31 1/2")	PTC105._	0.09m³ / 19kg / 2pcs	1.795
Ø 100 (39 1/2")	PTC108._	0.20m³ / 31kg / 2pcs	2.895
Ø 120 (47")	PTC109._	0.26m³ / 44kg / 2pcs	3.995
Ø 140 (55")	PTC115._	0.30m³ / 50kg / 2pcs	4.095
120x50 (47"x19 1/2")	PTC110._	0.20m³ / 23kg / 2pcs	2.095
140x70 (55"x27 1/2")	PTC111._	0.20m³ / 40kg / 2pcs	2.695
120x80 (47"x31 1/2")	PTC112._	0.20m³ / 33kg / 2pcs	2.595
159x79 (62 1/2"x31")	PTC114._	0.26m³ / 46kg / 2pcs	3.095

ABOUT COMPACTOP: MUCH MORE THAN A MERE SURFACE

Gaber Compactops are made of high-pressure laminate, consisting of numerous layers of paper saturated with thermosetting resins and bonded through the combined action of heat and high pressure. The paper used on Compactop (around 70% of the complete composition) comes from production processes that conform with the FSC chain of custody; phenolic and melamine resins are all strictly water-based.

The result is a stable, non-reactive, homogenous, non-porous, antistatic, high-density product with a totally distinct physical and chemical profile from that of its constituent parts. Thanks to the heat and high-pressure treatment it they undergo, Gaber Compactops are exceptionally tough and resistant to scratches, abrasions, chemicals and heat, making them ideal for a wide range of contract applications. Tops come pre-bored for Gaber kit bases.

Gaber Compactops conform to EN 438/1. According to this norm, the most important characteristics of Gaber Compactops are: their resistance to bumps, scratches, and wear and tear; color-fastness; easy cleanability; suitable for contact with food and general hygiene.

UNI EN 438 is the reference standard for Compactop Gaber tops. This standard prescribes tolerances in the flatness of the product and on possible stains and other similar surface defects, for which the admissible size is based on a maximum contamination area equivalent to 1mm² / m² of laminate, concentrated in a single point or distributed in more points, proportional to the size of the sheet under inspection.

MAINTENANCE & CLEANING

No specific maintenance other than normal cleaning is required. The compact, non porous surface can easily be cleaned and disinfected with hot water, steam and any common non-abrasive household detergents and disinfectants, as long as these are not highly alkaline. Just a couple of precautions are necessary: avoid using strong acids and bases and avoid wiping with highly abrasive substances or equipment.

CHE COS'È IL COMPACTOP? MOLTO PIÙ DI UNA SEMPLICE SUPERFICIE

Il Compactop che Gaber utilizza per i propri tavoli è un laminato realizzato ad alta pressione, costituito da numerosi strati di carta impregnati con resine termoindurenti fenoliche e melaminiche, compattati attraverso l'azione combinata di calore ed alta pressione. Le carte utilizzate (circa il 70% della composizione dei piani) derivano da processi che seguono il protocollo della catena di custodia certificata FSC; le resine fenoliche e melaminiche sono tutte rigorosamente realizzate su base acquosa.

Il risultato è un prodotto stabile, non reattivo, omogeneo, non poroso, antistatico e di alta densità. Grazie al trattamento di alta temperatura e pressione cui è sottoposto, il Compactop è un materiale estremamente robusto: resistente a graffi, urti, abrasioni, sostanze chimiche e calore; caratteristiche che lo rendono il materiale ideale per una vasta gamma di applicazioni. I fissaggi dei piani Compactop sono già predisposti per i basamenti Gaber.

Il Compactop è conforme alla norma EN 438/1, secondo la quale, queste sono le principali caratteristiche di qualità di questo materiale: Resistente all'impatto, ai graffi e all'usura, stabile alla luce, facile da pulire, igienico, adatto al contatto con i cibi.

La UNI EN 438 è la norma di riferimento dei piani in Compactop Gaber. Tale normativa prescrive tolleranze nella planarità del prodotto e su possibili macchie e altri difetti superficiali simili, per i quali la dimensione ammissibile è basata su un'area di contaminazione massima equivalente a 1mm²/m² di laminato, concentrata in un unico punto o dispersa in più punti, proporzionale alla dimensione del foglio sottoposto a ispezione.

MANUTENZIONE E PULIZIA

Il Compactop non richiede alcuna manutenzione particolare al di là della normale pulizia.

La sua superficie compatta e non porosa può essere facilmente pulita e disinfettata con acqua calda, vapore e tutti i tipi dei più comuni detergenti e disinfettanti per uso domestico, purché non alcalini. Sono necessarie solo poche precauzioni, quali evitare l'uso di acidi o basi forti, evitare di strofinare con sostanze o strumenti fortemente abrasivi.

Special Compactop Surfaces

Fullcolor



The white color of Compactop Fullcolor Surface is specific as it is combined with the color of the edge.
Il colore bianco del Compactop Fullcolor è specifico in quanto abbinato al colore del bordo



Chamfered edge
Bordo smussato

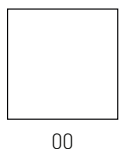
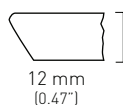

(min. 5pcs each code)
(min. 5pcs per codice)

Flat edge
Bordo piatto

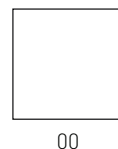
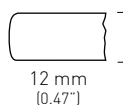

(min. 5pcs each code)
(min. 5pcs per codice)

Sizes / Misure	Code / Codice		DKK - kr	Sizes / Misure	Code / Codice		DKK - kr
Ø 60 (23 1/2")	PTC301.00	0.054m ³ / 12kg / 2pcs	1.495	Ø 60 (23 1/2")	PTC201.00	0.054m ³ / 12kg / 2pcs	1.495
Ø 68 (27")	PTC303.00	0.074m ³ / 14kg / 2pcs	1.795	Ø 68 (27")	PTC203.00	0.074m ³ / 14kg / 2pcs	1.795
Ø 80 (31 1/2")	PTC305.00	0.09m ³ / 19kg / 2pcs	2.095	Ø 80 (31 1/2")	PTC205.00	0.09m ³ / 19kg / 2pcs	2.095
Ø 100 (39 1/2")	PTC308.00	0.20m ³ / 31kg / 2pcs	4.695	Ø 100 (39 1/2")	PTC208.00	0.20m ³ / 31kg / 2pcs	4.695
Ø 120 (47")	PTC309.00	0.26m ³ / 44kg / 2pcs	4.895	Ø 120 (47")	PTC209.00	0.26m ³ / 44kg / 2pcs	4.895
Ø 140 (55")	PTC315.00	0.30m ³ / 50kg / 2pcs	5.295	Ø 140 (55")	PTC215.00	0.30m ³ / 50kg / 2pcs	5.295
59x59 (23"x23")	PTC302.00	0.054m ³ / 13kg / 2pcs	1.195	59x59 (23"x23")	PTC202.00	0.054m ³ / 13kg / 2pcs	1.195
68x68 (27"x27")	PTC304.00	0.074m ³ / 21kg / 2pcs	1.395	68x68 (27"x27")	PTC204.00	0.074m ³ / 21kg / 2pcs	1.395
79x79 (31"x31")	PTC306.00	0.090m ³ / 22kg / 2pcs	1.595	79x79 (31"x31")	PTC206.00	0.090m ³ / 22kg / 2pcs	1.595
89x89 (35"x35")	PTC307.00	0.11m ³ / 27kg / 2pcs	2.195	89x89 (35"x35")	PTC207.00	0.11m ³ / 27kg / 2pcs	2.195
120x50 (47"x19 1/2")	PTC310.00	0.20m ³ / 23kg / 2pcs	2.395	120x50 (47"x19 1/2")	PTC210.00	0.20m ³ / 23kg / 2pcs	2.395
140x70 (55"x27 1/2")	PTC311.00	0.20m ³ / 40kg / 2pcs	3.195	140x70 (55"x27 1/2")	PTC211.00	0.20m ³ / 40kg / 2pcs	3.195
120x80 (47"x31 1/2")	PTC312.00	0.20m ³ / 33kg / 2pcs	3.095	120x80 (47"x31 1/2")	PTC212.00	0.20m ³ / 33kg / 2pcs	3.095
159x79 (62 1/2"x31")	PTC314.00	0.26m ³ / 46kg / 2pcs	3.595	159x79 (62 1/2"x31")	PTC214.00	0.26m ³ / 46kg / 2pcs	3.595

ABOUT COMPACTOP: MUCH MORE THAN A MERE SURFACE

Gaber Compactops are made of high-pressure laminate, consisting of numerous layers of paper saturated with thermosetting resins and bonded through the combined action of heat and high pressure. The paper used on Compactop (around 70% of the complete composition) comes from production processes that conform with the FSC chain of custody; phenolic and melamine resins are all strictly water-based.

The result is a stable, non-reactive, homogenous, non-porous, antistatic, high-density product with a totally distinct physical and chemical profile from that of its constituent parts. Thanks to the heat and high-pressure treatment it they undergo, Gaber Compactops are exceptionally tough and resistant to scratches, abrasions, chemicals and heat, making them ideal for a wide range of contract applications. Tops come pre-bored for Gaber kit bases.

Gaber Compactops conform to EN 438/1. According to this norm, the most important characteristics of Gaber Compactops are: their resistance to bumps, scratches, and wear and tear; color-fastness; easy cleanability; suitable for contact with food and general hygiene.

UNI EN 438 is the reference standard for Compactop Gaber tops. This standard prescribes tolerances in the flatness of the product and on possible stains and other similar surface defects, for which the admissible size is based on a maximum contamination area equivalent to 1mm² / m² of laminate, concentrated in a single point or distributed in more points, proportional to the size of the sheet under inspection.

MAINTENANCE & CLEANING

No specific maintenance other than normal cleaning is required. The compact, non porous surface can easily be cleaned and disinfected with hot water, steam and any common non-abrasive household detergents and disinfectants, as long as these are not highly alkaline. Just a couple of precautions are necessary: avoid using strong acids and bases and avoid wiping with highly abrasive substances or equipment.

CHE COS'È IL COMPACTOP? MOLTO PIÙ DI UNA SEMPLICE SUPERFICIE

Il Compactop che Gaber utilizza per i propri tavoli è un laminato realizzato ad alta pressione, costituito da numerosi strati di carta impregnati con resine termoindurenti fenoliche e melaminiche, compattati attraverso l'azione combinata di calore ed alta pressione. Le carte utilizzate (circa il 70% della composizione dei piani) derivano da processi che seguono il protocollo della catena di custodia certificata FSC; le resine fenoliche e melaminiche sono tutte rigorosamente realizzate su base acquosa.

Il risultato è un prodotto stabile, non reattivo, omogeneo, non poroso, antistatico e di alta densità. Grazie al trattamento di alta temperatura e pressione cui è sottoposto, il Compactop è un materiale estremamente robusto: resistente a graffi, urti, abrasioni, sostanze chimiche e calore; caratteristiche che lo rendono il materiale ideale per una vasta gamma di applicazioni. I fissaggi dei piani Compactop sono già predisposti per i basamenti Gaber.

Il Compactop è conforme alla norma EN 438/1, secondo la quale, queste sono le principali caratteristiche di qualità di questo materiale: Resistente all'impatto, ai graffi e all'usura, stabile alla luce, facile da pulire, igienico, adatto al contatto con i cibi.

La UNI EN 438 è la norma di riferimento dei piani in Compactop Gaber. Tale normativa prescrive tolleranze nella planarità del prodotto e su possibili macchie e altri difetti superficiali simili, per i quali la dimensione ammissibile è basata su un'area di contaminazione massima equivalente a 1mm²/m² di laminato, concentrata in un unico punto o dispersa in più punti, proporzionale alla dimensione del foglio sottoposto a ispezione.

MANUTENZIONE E PULIZIA

Il Compactop non richiede alcuna manutenzione particolare al di là della normale pulizia.

La sua superficie compatta e non porosa può essere facilmente pulita e disinfettata con acqua calda, vapore e tutti i tipi dei più comuni detergenti e disinfettanti per uso domestico, purché non alcalini. Sono necessarie solo poche precauzioni, quali l'evitare l'uso di acidi o basi forti, evitare di strofinare con sostanze o strumenti fortemente abrasivi.

Special Compactop Surfaces

10



Flat black edge
Bordo piatto nero

10 mm
(0.39")

(min. 20pcs each code)
(min. 20pcs per codice)

Solid

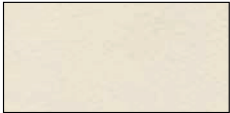

244

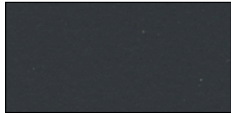

526

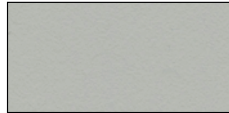

527

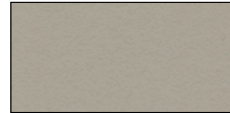

247

Stone, Concrete effect

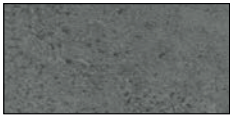

3192

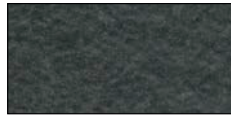

3349



3276



3329

Wood effect



4529

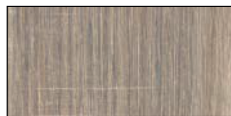

4543



4587



4511

Marble effect

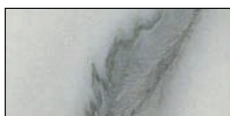

5547





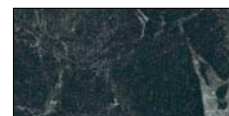

6075



6076



6089

	Sizes / Misure	Code / Codice		DKK - kr
	Ø 60 (23 ½")	PTC501. __	0.700m ³ / 95kg / 20pcs	1.295
	Ø 68 (27")	PTC503. __	0.700m ³ / 120kg / 20pcs	1.495
	Ø 80 (31 ½")	PTC505. __	0.84m ³ / 185kg / 20pcs	1.795
	Ø 100 (39 ½")	PTC508. __	1.20m ³ / 285kg / 20pcs	2.695
	Ø 120 (47")	PTC509. __	1.20m ³ / 405kg / 20pcs	3.695
	Ø 140 (55")	PTC515. __	1.60m ³ / 535kg / 20pcs	3.895
	59x59 (23"x23")	PTC502. __	0.700m ³ / 115kg / 20pcs	995
	68x68 (27"x27")	PTC504. __	0.700m ³ / 155kg / 20pcs	1.195
	79x79 (31"x31")	PTC506. __	0.840m ³ / 195kg / 20pcs	1.295
	89x89 (35"x35")	PTC507. __	0.840m ³ / 245kg / 20pcs	1.795
	120x50 (47"x19 ½")	PTC510. __	0.84m ³ / 225kg / 20pcs	1.895
	140x70 (55"x27 ½")	PTC511. __	0.95m ³ / 355kg / 20pcs	2.595
	120x80 (47"x31 ½")	PTC512. __	0.84m ³ / 345kg / 20pcs	2.395
	159x79 (62 ½"x31")	PTC514. __	1.20m ³ / 455kg / 20pcs	2.895

ABOUT COMPACTOP: MUCH MORE THAN A MERE SURFACE

Gaber Compactops are made of high-pressure laminate, consisting of numerous layers of paper saturated with thermosetting resins and bonded through the combined action of heat and high pressure. The paper used on Compactop (around 70% of the complete composition) comes from production processes that conform with the FSC chain of custody; phenolic and melamine resins are all strictly water-based. The result is a stable, non-reactive, homogenous, non-porous, antistatic, high-density product with a totally distinct physical and chemical profile from that of its constituent parts. Thanks to the heat and high-pressure treatment it undergoes, Gaber Compactops are exceptionally tough and resistant to scratches, abrasions, chemicals and heat, making them ideal for a wide range of contract applications. Tops come pre-bored for Gaber kit bases. Gaber Compactops conform to EN 438/1. According to this norm, the most important characteristics of Gaber Compactops are: their resistance to bumps, scratches, and wear and tear; color-fastness; easy cleanability; suitable for contact with food and general hygiene. UNI EN 438 is the reference standard for Compactop Gaber tops. This standard prescribes tolerances in the flatness of the product and on possible stains and other similar surface defects, for which the admissible size is based on a maximum contamination area equivalent to 1mm² / m² of laminate, concentrated in a single point or distributed in more points, proportional to the size of the sheet under inspection.

MAINTENANCE & CLEANING

No specific maintenance other than normal cleaning is required. The compact, non porous surface can easily be cleaned and disinfected with hot water, steam and any common non-abrasive household detergents and disinfectants, as long as these are not highly alkaline. Just a couple of precautions are necessary: avoid using strong acids and bases and avoid wiping with highly abrasive substances or equipment.

CHE COS'È IL COMPACTOP? MOLTO PIÙ DI UNA SEMPLICE SUPERFICIE

Il Compactop che Gaber utilizza per i propri tavoli è un laminato realizzato ad alta pressione, costituito da numerosi strati di carta impregnati con resine termoindurenti fenoliche e melaminiche, compattati attraverso l'azione combinata di calore ed alta pressione. Le carte utilizzate (circa il 70% della composizione dei piani) derivano da processi che seguono il protocollo della catena di custodia certificata FSC; le resine fenoliche e melaminiche sono tutte rigorosamente realizzate su base acquosa. Il risultato è un prodotto stabile, non reattivo, omogeneo, non poroso, antistatico e di alta densità. Grazie al trattamento di alta temperatura e pressione cui è sottoposto, il Compactop è un materiale estremamente robusto: resistente a graffi, urti, abrasioni, sostanze chimiche e calore; caratteristiche che lo rendono il materiale ideale per una vasta gamma di applicazioni. I fissaggi dei piani Compactop sono già predisposti per i basamenti Gaber. Il Compactop è conforme alla norma EN 438/1, secondo la quale, queste sono le principali caratteristiche di qualità di questo materiale: Resistente all'impatto, ai graffi e all'usura, stabile alla luce, facile da pulire, igienico, adatto al contatto con i cibi.

La UNI EN 438 è la norma di riferimento dei piani in Compactop Gaber. Tale normativa prescrive tolleranze nella planarità del prodotto e su possibili macchie e altri difetti superficiali simili, per i quali la dimensione ammissibile è basata su un'area di contaminazione massima equivalente a 1mm²/m² di laminato, concentrata in un unico punto o dispersa in più punti, proporzionale alla dimensione del foglio sottoposto a ispezione.

MANUTENZIONE E PULIZIA

Il Compactop non richiede alcuna manutenzione particolare al di là della normale pulizia.

La sua superficie compatta e non porosa può essere facilmente pulita e disinfettata con acqua calda, vapore e tutti i tipi dei più comuni detergenti e disinfettanti per uso domestico, purché non alcalini. Sono necessarie solo poche precauzioni, quali l'evitare l'uso di acidi o basi forti, evitare di strofinare con sostanze o strumenti fortemente abrasivi.

Special Compactop Surfaces

Fenix

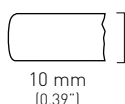

Flat black edge
Bordo piatto nero

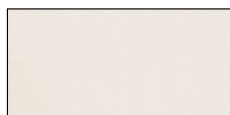

(min. 20pcs each code)
(min. 20pcs per codice)



0029



0720

	Sizes / Misure	Code / Codice		DKK - kr
	Ø 60 (23 ½")	PTC401. __	0.70m³ / 95kg / 20pcs	1.495
	Ø 68 (27")	PTC403. __	0.70m³ / 120kg / 20pcs	1.795
	59x59 (23"x23")	PTC402. __	0.70m³ / 115kg / 20pcs	1.195
	68x68 (27"x27")	PTC404. __	0.70m³ / 155kg / 20pcs	1.395
	79x79 (31"x31")	PTC406. __	0.84m³ / 195kg / 20pcs	1.595
	89x89 (35"x35")	PTC407. __	0.84m³ / 245kg / 20pcs	2.095

ABOUT FENIX COMPACTOP

Gaber's Fenix Compactop differ from standards as they are built with new generation materials on exposed coated surfaces, made using nanoparticles and acrylic resins. This coating avoid fingerprints on the material, make it soft-touch, heat-repairing, opaque and extremely resistant to bumps and scratches. In addition to this, the material is water repellent, hygienic, easy to clean and suitable for food-contact.

MAINTENANCE & CLEANING

No specific maintenance other than normal cleaning is required. The compact, non porous surface can easily be cleaned and disinfected with a soft cloth dampened with hot water, steam and any common non-abrasive household detergents and disinfectants, as long as these are not highly alkaline. Just a couple of precautions are necessary: avoid using strong acids and bases and avoid wiping with highly abrasive substances or equipment.

CHE COS'E' IL FENIX COMPACTOP

I piani Compactop Fenix di Gaber differiscono dagli standard in quanto prevedono l'utilizzo delle superfici esposte rivestite con materiali di nuova generazione, realizzati per mezzo dell'uso di nanoparticelle e resine acriliche. Tali rivestimenti rendono il materiale anti-impronta, morbido al tatto, termo-riparatore, opaco ed estremamente resistente ad urti e graffi. Oltre a ciò, il materiale è idrorepellente, igienico, resistente alle muffe, facile da pulire e adatto al contatto con alimenti.

MANUTENZIONE E PULIZIA

Il Compactop non richiede alcuna manutenzione particolare al di là della normale pulizia.

La sua superficie compatta e non porosa può essere facilmente pulita e disinfettata con un panno umido, acqua calda, vapore e tutti i tipi dei più comuni detergenti e disinfettanti per uso domestico, purché non alcalini. Sono necessarie solo poche precauzioni, quali l'evitare l'uso di acidi o basi forti, evitare di strofinare con sostanze o strumenti fortemente abrasivi.

Standard Laminated Surfaces

22



Bottom surfaces of our laminated tops are in white, black or dark grey colors.
Il fondo del piano laminato può essere con colore bianco, nero o grigio antracite.



22 mm
(0.86")



25 mm
(0.98")



F

W





RN

00



10

For orders under 10no. surcharge 150 DKK each

	Sizes / Misure	Code / Codice		DKK - kr
	Ø 60 (23 ½")	PTL101.__	0.054m³ / 11kg / 2pcs	895
	Ø 70 (27 ½")	PTL103.__	0.074m³ / 13kg / 2pcs	1.095
	Ø 80 (31 ½")	PTL105.__	0.090m³ / 14kg / 2pcs	1.495
	Ø 90 (35 ½")	PTL127.__	0.110m³ / 16kg / 2pcs	1.795
	Ø 100 (39 ½")	PTL108.__	0.200m³ / 20kg / 2pcs	2.595
	Ø 120 (47")	PTL109.__	0.260m³ / 27kg / 2pcs	3.095
	Ø 140 (55")	PTL115.__	0.300m³ / 33kg / 2pcs	3.695
	60x60 (23 ½"X23 ½")	PTL102.__	0.054m³ / 13kg / 2pcs	795
	70x70 (27 ½"X27 ½")	PTL104.__	0.074m³ / 19kg / 2pcs	895
	80x80 (31 ½"X31 ½")	PTL106.__	0.090m³ / 24kg / 2pcs	995
	90x90 (35 ½"X35 ½")	PTL107.__	0.110m³ / 27kg / 2pcs	1.295
	100x100 (39 ½"X39 ½")	PTL128.__	0.200m³ / 28kg / 2pcs	1.995
	120x50 (47"X19 ½")	PTL110.__	0.110m³ / 27kg / 2pcs	1.295
	120x80 (47"X31 ½")	PTL112.__	0.200m³ / 30kg / 2pcs	1.495
	140x70 (55"X27 ½")	PTL111.__	0.200m³ / 34kg / 2pcs	1.595
	160x80 (63"X31 ½")	PTL114.__	0.260m³ / 36kg / 2pcs	2.395

ABOUT LAMINATED TABLE TOPS

Gaber's laminate table tops are composed of a high-pressure decorative laminate layer, with a recycled-wood chipboard core and ABS edging. Gaber's support materials are E1 according to tests stipulated by the European standards EN717 and EN120 regarding formaldehyde emission. Laminate tops come ready for Gaber kit bases.

The result is homogeneous, static, lightweight and highly customizable in terms of shapes and finishes.

Our laminate tops are manufactured according to the following European Standards related to fire reaction: EN 13501-1:2009 B -s2, d0.

MAINTENANCE & CLEANING

Gaber laminated table tops do not require any special maintenance beyond normal cleaning.

Laminated surfaces can be easily cleaned with a soft cloth dampened with water, even with cleaning agents, but not alkaline and generally aggressive. Avoid the use of strong acids or bases, avoid wiping with abrasive substances or equipment.

COSA SONO I PIANI DEI TAVOLI IN LAMINATO?

I ripiani laminati che Gaber utilizza per i propri tavoli sono composti da uno strato di laminato decorativo ad alta pressione, supportato da un pannello di truciolare; quest'ultimo realizzato con i materiali di scarto delle normali lavorazioni del legno. I piani sono bordati con bordo in Abs. La tipologia di supporto utilizzato da Gaber per i propri piani è di classe E1 secondo i test espressi dalle normative europee EN717 e EN120 in materia di emissione di formaldeide. I fissaggi dei ripiani in laminato sono già predisposti per i basamenti Gaber.

Il risultato è un prodotto omogeneo, antistatico, leggero e facilmente personalizzabile in forme e finiture.

I nostri piani in laminato sono realizzati secondo la normativa europea di reazione al fuoco EN 13501-1:2009 B -s2, d0.

MANUTENZIONE E PULIZIA

I piani laminati di Gaber non richiedono alcuna manutenzione particolare al di là della normale pulizia.

La sua superficie può essere facilmente pulita con un panno morbido imbevuto di acqua, anche con detersivi per uso domestico, purché non alcalini ed in genere aggressivi. Evitare l'uso di acidi o basi forti, evitare di strofinare con sostanze o strumenti abrasivi.

Standard Laminated Surfaces

50





Bottom surfaces of our laminated tops are in white, black or dark grey colors. Il fondo del piano laminato può essere con colore bianco, nero o grigio antracite.

50 mm (1.96")
20 mm
42 mm



F W RN 00 10

For orders under 10no. surcharge DKK 150 each

	Sizes / Misure	Code / Codice		DKK - kr
	60x60 (23 1/2"X23 1/2")	PTL202.__	0.054m ³ / 7kg / 1pcs	895
	70x70 (27 1/2"X27 1/2")	PTL204.__	0.074m ³ / 9kg / 1pcs	1.295
	80x80 (31 1/2"X31 1/2")	PTL206.__	0.090m ³ / 13kg / 1pcs	1.795
	90x90 (35 1/2"X35 1/2")	PTL207.__	0.110m ³ / 15kg / 1pcs	1.895
	100x100 (39 1/2"X39 1/2")	PTL228.__	0.200m ³ / 16kg / 1pcs	2.495
	120x80 (47"X31 1/2")	PTL212.__	0.200m ³ / 17kg / 1pcs	2.195

ABOUT LAMINATED TABLE TOPS

Gaber's laminate table tops are composed of a high-pressure decorative laminate layer, with a recycled-wood chipboard core and ABS edging. Gaber's support materials are E1 according to tests stipulated by the European standards EN717 and EN120 regarding formaldehyde emission. Laminate tops come ready for Gaber kit bases.

The result is homogeneous, static, lightweight and highly customizable in terms of shapes and finishes.

Our laminate tops are manufactures according the following European Standards related to fire reaction: EN 13501-1:2009 B -s2, d0.

MAINTENANCE & CLEANING

Gaber laminated table tops do not require any special maintenance beyond normal cleaning.

Laminated surfaces can be easily cleaned with a soft cloth dampened with water, even with cleaning agents, but not alkaline and generally aggressive. Avoid the use of strong acids or bases, avoid wiping with abrasive substances or equipment.

COSA SONO I PIANI DEI TAVOLI IN LAMINATO?

I ripiani laminati che Gaber utilizza per i propri tavoli sono composti da uno strato di laminato decorativo ad alta pressione, supportato da un pannello di truciolare; quest'ultimo realizzato con i materiali di scarto delle normali lavorazioni del legno. I piani sono bordati con bordo in Abs. La tipologia di supporto utilizzato da Gaber per i propri piani è di classe E1 secondo i test espressi dalle normative europee EN717 e EN120 in materia di emissione di formaldeide. I fissaggi dei ripiani in Laminato sono già predisposti per i basamenti Gaber.

Il risultato è un prodotto omogeneo, antistatico, leggero e facilmente personalizzabile in forme e finiture.

I nostri piani in laminato sono realizzati secondo la normativa europea di reazione al fuoco EN 13501-1:2009 B -s2, d0.

MANUTENZIONE E PULIZIA

I piani Laminati di Gaber non richiedono alcuna manutenzione particolare al di là della normale pulizia.

La sua superficie può essere facilmente pulita con un panno morbido imbevuto di acqua, anche con detersivi per uso domestico, purché non alcalini ed in genere aggressivi. Evitare l'uso di acidi o basi forti, evitare di strofinare con sostanze o strumenti abrasivi.

Special Laminated Surfaces

Wood Effect 25



 25 mm (0.98") (min. 20pcs each code) (min. 20pcs per codice)

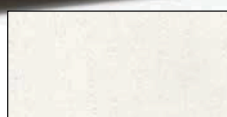

B01

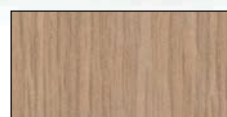

X41



61M

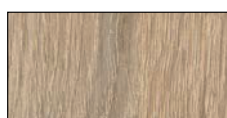





V32

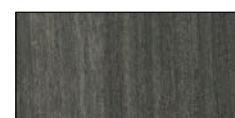

WG8



WG9

	Sizes / Misure	Code / Codice		DKK - kr
	Ø 60 (23 1/2")	PTL301.__	0.700m ³ / 85kg / 20pcs	995
	Ø 70 (27 1/2")	PTL303.__	0.700m ³ / 105kg / 20pcs	1.195
	Ø 80 (31 1/2")	PTL305.__	0.840m ³ / 125kg / 20pcs	1.695
	Ø 90 (35 1/2")	PTL327.__	0.840m ³ / 155kg / 20pcs	1.995
	Ø 100 (39 1/2")	PTL308.__	1.200m ³ / 190kg / 20pcs	2.695
	Ø 120 (47")	PTL309.__	1.200m ³ / 270kg / 20pcs	3.095
	Ø 140 (55")	PTL315.__	1.600m ³ / 325kg / 20pcs	3.695
	60x60 (23 1/2"X23 1/2")	PTL302.__	0.700m ³ / 95kg / 20pcs	895
	70x70 (27 1/2"X27 1/2")	PTL304.__	0.700m ³ / 125kg / 20pcs	995
	80x80 (31 1/2"X31 1/2")	PTL306.__	0.840m ³ / 160kg / 20pcs	1.095
	90x90 (35 1/2"X35 1/2")	PTL307.__	0.840m ³ / 195kg / 20pcs	1.395
	100x100 (39 1/2"X39 1/2")	PTL328.__	1.200m ³ / 235kg / 20pcs	2.095
	120x50 (47"X19 1/2")	PTL310.__	0.840m ³ / 155kg / 20pcs	1.495
	120x80 (47"X31 1/2")	PTL312.__	0.840m ³ / 235kg / 20pcs	1.495
	140x70 (55"X27 1/2")	PTL311.__	0.950m ³ / 240kg / 20pcs	1.695
	160x80 (63"X31 1/2")	PTL314.__	1.200m ³ / 300kg / 20pcs	2.395

ABOUT LAMINATED TABLE TOPS

Gaber's laminate table tops are composed of a high-pressure decorative laminate layer, with a recycled-wood chipboard core and ABS edging. Gaber's support materials are E1 according to tests stipulated by the European standards EN717 and EN120 regarding formaldehyde emission. Laminate tops come ready for Gaber kit bases.

The result is homogeneous, static, lightweight and highly customizable in terms of shapes and finishes.

To optimize the production process, sizes may vary in tolerance ± 5 mm.

MAINTENANCE & CLEANING

Gaber laminated table tops do not require any special maintenance beyond normal cleaning.

Laminated surfaces can be easily cleaned with a soft cloth dampened with water, even with cleaning agents, but not alkaline and generally aggressive. Avoid the use of strong acids or bases, avoid wiping with abrasive substances or equipment.

COSA SONO I PIANI DEI TAVOLI IN LAMINATO?

I ripiani laminati che Gaber utilizza per i propri tavoli sono composti da uno strato di laminato decorativo ad alta pressione, supportato da un pannello di truciolare; quest'ultimo realizzato con i materiali di scarto delle normali lavorazioni del legno. I piani sono bordati con bordo in Abs. La tipologia di supporto utilizzato da Gaber per i propri piani è di classe E1 secondo i test espressi dalle normative europee EN717 e EN120 in materia di emissione di formaldeide. I fissaggi dei ripiani in Laminato sono già predisposti per i basamenti Gaber.

Il risultato è un prodotto omogeneo, antistatico, leggero e facilmente personalizzabile in forme e finiture.

Ad ottimizzazione delle lavorazioni, le dimensioni possono variare nella tolleranza di ± 5 mm.

MANUTENZIONE E PULIZIA

I piani Laminati di Gaber non richiedono alcuna manutenzione particolare al di là della normale pulizia.

La sua superficie può essere facilmente pulita con un panno morbido imbevuto di acqua, anche con detersivi per uso domestico, purché non alcalini ed in genere aggressivi. Evitare l'uso di acidi o basi forti, evitare di strofinare con sostanze o strumenti abrasivi.

Special Laminated Surfaces

Fenix 25



 25 mm (0.98") (min. 20pcs each code) (min. 20pcs per codice)

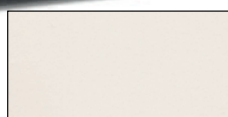

0029

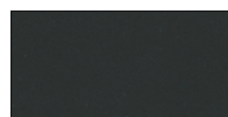

720

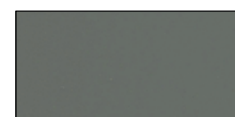

718







2630



2629



2628

	Sizes / Misure	Code / Codice		DKK - kr
	Ø 60 (23 1/2")	PTL401.__	0.700m ³ / 85kg / 20pcs	995
	Ø 70 (27 1/2")	PTL403.__	0.700m ³ / 105kg / 20pcs	1.195
	Ø 80 (31 1/2")	PTL405.__	0.840m ³ / 125kg / 20pcs	1.695
	Ø 90 (35 1/2")	PTL427.__	0.840m ³ / 155kg / 20pcs	1.995
	Ø 100 (39 1/2")	PTL408.__	1.200m ³ / 190kg / 20pcs	2.695
	Ø 120 (47")	PTL409.__	1.200m ³ / 270kg / 20pcs	3.095
	Ø 140 (55")	PTL415.__	1.600m ³ / 325kg / 20pcs	3.695
	60x60 (23 1/2"X23 1/2")	PTL402.__	0.700m ³ / 95kg / 20pcs	895
	70x70 (27 1/2"X27 1/2")	PTL404.__	0.700m ³ / 125kg / 20pcs	995
	80x80 (31 1/2"X31 1/2")	PTL406.__	0.840m ³ / 160kg / 20pcs	1.095
	90x90 (35 1/2"X35 1/2")	PTL407.__	0.840m ³ / 195kg / 20pcs	1.395
	100x100 (39 1/2"X39 1/2")	PTL428.__	1.200m ³ / 235kg / 20pcs	2.095
	120x50 (47"X19 1/2")	PTL410.__	0.840m ³ / 155kg / 20pcs	1.495
	120x80 (47"X31 1/2")	PTL412.__	0.840m ³ / 235kg / 20pcs	1.495
	140x70 (55"X27 1/2")	PTL411.__	0.950m ³ / 240kg / 20pcs	1.695
	160x80 (63"X31 1/2")	PTL414.__	1.200m ³ / 300kg / 20pcs	2.395

ABOUT FENIX LAMINATED TABLE TOPS

Gaber's Fenix laminated table tops are composed of a decorative Fenix laminate layer, with a recycled-wood chipboard core. Tops utilize ABS edging, made using nanoparticles and acrylic resins. This coating avoids fingerprints on the material, makes it soft-touch, heat-repairing, opaque and extremely resistant to bumps and scratches. In addition to this, the material is water repellent, hygienic, easy to clean and suitable for food-contact. Gaber's support materials are E1 according to tests stipulated by the European standards EN717 and EN120 regarding formaldehyde emission. Laminated tops come ready for Gaber kit bases. To optimize the production process, sizes may vary in tolerance ±5mm.

MAINTENANCE & CLEANING

Gaber laminated table tops do not require any special maintenance beyond normal cleaning.

Laminated surfaces can be easily cleaned with a soft cloth dampened with water, even with cleaning agents, but not alkaline and generally aggressive. Avoid the use of strong acids or bases, avoid wiping with abrasive substances or equipment.

CHE COSA SONO I PIANI DEI TAVOLI IN LAMINATO FENIX?

I ripiani laminati che Gaber utilizza per i propri tavoli sono composti da uno strato di laminato Fenix decorativo, supportato da un pannello truciolare; quest'ultimo realizzato con i materiali di scarto delle normali lavorazioni del legno. I piani sono bordati in ABS, realizzato per mezzo dell'uso di nanoparticelle e resine acriliche. Tali rivestimenti rendono il materiale anti-impronta, morbido al tatto, termoriparatore, opaco ed estremamente resistente ad urti e graffi. Oltre a ciò il materiale è idrorepellente, igienico, resistente alle muffe, facile da pulire e adatto al contatto con alimenti. La tipologia di supporto utilizzato da Gaber per i propri piani è di classe E1 secondo i test espressi dalle normative europee EN717 e EN120 in materia di emissione di formaldeide. I fissaggi dei ripiani in Laminato sono già predisposti per i basamenti Gaber. Ad ottimizzazione delle lavorazioni, le dimensioni possono variare nella tolleranza di ±5mm.



MANUTENZIONE E PULIZIA

I piani laminati di Gaber non richiedono alcuna manutenzione particolare al di là della normale pulizia.

La sua superficie può essere facilmente pulita con un panno morbido imbevuto di acqua, anche con detersivi per uso domestico, purché non alcalini ed in genere aggressivi. Evitare l'uso di acidi o basi forti, evitare di strofinare con sostanze o strumenti abrasivi.

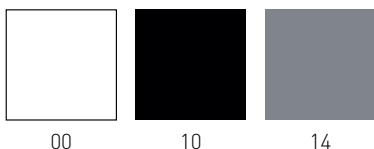
Iron Surfaces



	Sizes / Misure	Code / Codice		DKK - kr
	60x60 (23 1/2" X 23 1/2")	PTI102._	0.054m ³ / 16.4kg / 2pcs	1.395
	70x70 (27 1/2" X 27 1/2")	PTI104._	0.074m ³ / 21.6kg / 2pcs	1.495
	80x80 (31 1/2" X 31 1/2")	PTI106._	0.090m ³ / 22kg / 2pcs	1.695
	120x80 (47" X 31 1/2")	PTI112._	0.20m ³ / 31.2kg / 2pcs	3.595

ABOUT IRON TABLE TOPS

Gaber's Iron table tops are made of composite materials: a non-deformable water-repellent multilayer wood-based core, covered in steel. The slim line result is elegant, stylish and practical. Iron tops come pre-bored for Gaber kit bases. These tough materials make iron tops suitable for indoor as well as outdoor use.

MAINTENANCE & CLEANING

Gaber's Iron table tops do not require any special maintenance beyond normal cleaning.

Its surface can be easily cleaned with a soft cloth dampened with water, even with household cleaning detergent, provided they are not alkaline and generally aggressive. Avoid the use of strong acids or bases, avoid rubbing with abrasive substances or devices.

COSA SONO I PIANI DEI TAVOLI IRON?

I sistemi Iron che Gaber utilizza per i propri piani dei tavoli sono realizzati da materiali compositi: il cuore del sistema è realizzato con un materiale multistrato, a base legnosa, resistente all'umidità, di grande stabilità. Il rivestimento in acciaio e lo spessore contenuto rendono il prodotto elegante, raffinato e pratico. I fissaggi dei piani Iron sono già predisposti per i basamenti Gaber. Le finiture disponibili lo rendono adatto anche all'uso per outdoor, grazie all'ottimale resistenza agli agenti atmosferici.



MANUTENZIONE E PULIZIA

I piani Iron di Gaber non richiedono alcuna manutenzione particolare al di là della normale pulizia.

La sua superficie può essere facilmente pulita con un panno morbido imbevuto di acqua, anche con detersivi per uso domestico, purché non alcalini ed in genere aggressivi. Evitare l'uso di acidi o basi forti, evitare di strofinare con sostanze o strumenti abrasivi.

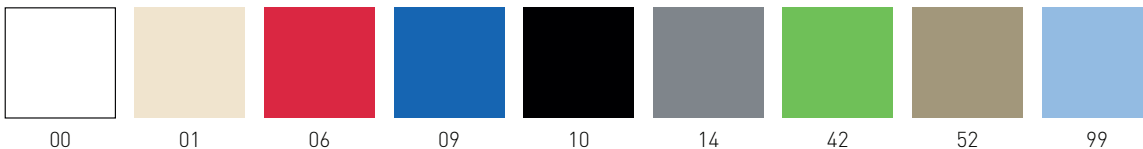
Techno Polymer Table Tops



	Sizes / Misure	Code / Codice		DKK - kr
	Ø 60 (23 ½")	PTT04._	0.054m³ / 4kg / 1pcs	695
	Ø 72 (28 ½")	PTT03._	0.074m³ / 4.7kg / 1pcs	895
	60x60 (23 ½"X23 ½")	PTT20._	0.054m³ / 4.8kg / 1pcs	895
	72x72 (28 ½"X28 ½")	PTT06._	0.074m³ / 6kg / 1pcs	1.095
	80x80 (31 ½"X31 ½")	PTT23._	0.090m³ / 8.6kg / 1pcs	1.195

ABOUT TECHNO POLYMER TABLE-TOPS

The Techno Polymer Compounds Gaber uses on its table tops have high structural, heat and abrasion resistance. Gaber's technopolymer table tops are practical, shock-resistant, colorful and inexpensive.

Gaber technopolymers are non-toxic, stain-resistant, antistatic and UV-resistant and consequently have excellent resistance to atmospheric agents. All these materials are recyclable in the full respect of our Natural Environment. Gaber produces plastic injected materials without added chemicals and, as far as possible, recycled pre-used technopolymers are sourced as a base raw material. Technopolymer table top colors perfectly match the colors of Gaber's seating collection.

MAINTENANCE & CLEANING

The plastic surfaces of Gaber products can generally be cleaned with a cloth and warm water. For the most persistent stains, a small amount of liquid soap diluted in water may be used. Do not use acetone, trichloroethylene, ammonia, alcoholic substances and detergents that contain even just a small amount of these substances. We also recommend avoiding all types of abrasive and solvent substances or rough sponges.

COME SONO FATTI I RIPIANI IN TECNOPOLIMERO?

I piani in Tecnopolimero utilizzati da Gaber per i propri tavoli sono realizzati per mezzo del processo di iniezione plastica. I piani così realizzati sono pratici, resistenti agli urti, colorati ed economici. I compound di tecnopolimeri utilizzati da Gaber nella realizzazione dei propri prodotti sono caratterizzati da un'elevata resistenza strutturale, termica e all'abrasione. Il tecnopolimero è atossico, antimacchia, antistatico e anti-uv: qualità che lo rendono ottimamente resistente agli agenti atmosferici. I tecnopolimeri utilizzati da Gaber sono integralmente riciclabili, nel pieno rispetto del nostro Ambiente Naturale. Gaber produce articoli termoplastici senza additivi chimici e, ove possibile, vengono utilizzati tecnopolimeri riciclati derivanti da post-consumo. I colori dei ripiani dei tavoli corrispondono ai colori della vasta collezione di sedute Gaber.

MANUTENZIONE E PULIZIA

Le superfici in tecno polimero dei piani dei tavoli Gaber possono essere pulite con un panno umido e soffice imbevuto in acqua. Per le macchie più ostinate è possibile diluire in acqua del sapone neutro liquido con moderazione. Non utilizzare acetone, trielina, ammoniaca, sostanze alcoliche o detersivi che contengano anche piccole quantità di tali detersivi. Non utilizzare a contatto con il prodotto sostanze abrasive o solventi, strumenti di pulizia ruvidi.

TABLE BASES Collection

ARKET 3 BASE

H49-H73-H109 3 spur aluminum casted base, column made in aluminum extruded tube, aluminum cross and adjustable feet. Basamento per tavolo H49-H73-H109 con 3 razze e crociera in alluminio pressofuso, colonna in alluminio estruso. Piedini regolabili.

Top max dimensions / Massima dimensione piano

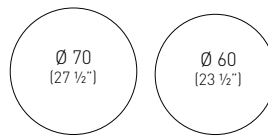

Available table tops / Piani tavolo disponibili

compactop laminated



Frame Color / Colore Struttura

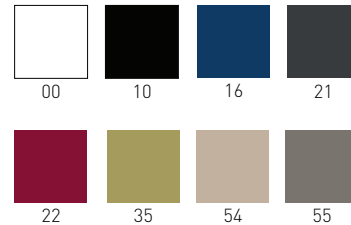

H49	BAK3B._		0.055m³ / 3.5kg / 1pcs	DKK - kr	1.295
H73	BAK3._		0.055m³ / 4.0kg / 1pcs		1.295
H109	BAK3A._		0.085m³ / 4.2kg / 1pcs		1.695

Minimum order 20 pcs each code, unless combined with Gaber table tops. Ordine minimo 20 pezzi per codice, se non abbinato a piani Gaber.

ARKET 4 BASE

H49-H73-H109 4 spur aluminum casted base, column made in aluminum extruded tube, aluminum cross and adjustable feet. Basamento per tavolo H49-H73-H109 con 4 razze e crociera in alluminio pressofuso, colonna in alluminio estruso. Piedini regolabili.

Top max dimensions / Massima dimensione piano

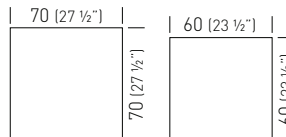

Available table tops / Piani tavolo disponibili

compactop laminated



Frame Color / Colore Struttura

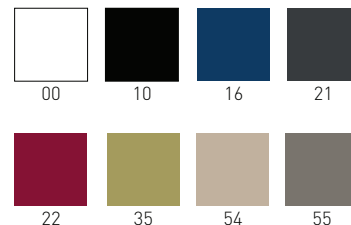

H49	BAK4B._		0.055m³ / 4.2kg / 1pcs	DKK - kr	1.295
H73	BAK4._		0.055m³ / 4.5kg / 1pcs		1.395
H109	BAK4A._		0.085m³ / 4.8kg / 1pcs		1.795

Minimum order 20 pcs each code, unless combined with Gaber table tops. Ordine minimo 20 pezzi per codice, se non abbinato a piani Gaber.

ARKET PLUS

H73 3 spur metal-technopolymer co-injected table base, aluminum column and cross, flip-top mechanism. Base per tavolo pieghevole H73 a tre razze in metallo sovrastampato con tecnopolimero, colonna e crociera in alluminio.

Top max dimensions / Massima dimensione piano

Available table tops / Piani tavolo disponibili

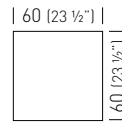
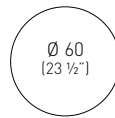

compactop laminated

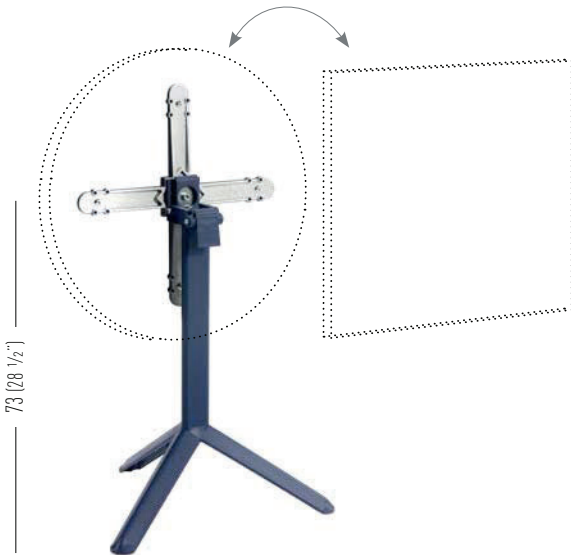

Frame Color / Colore Struttura

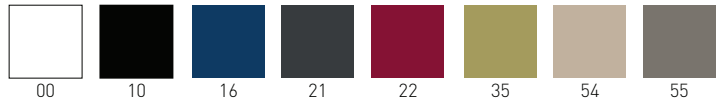

BAKP. __



0.12m³ / 5.5kg / 1pc

DKK - kr

1.695

BG3K

H73 3-spur metal-technopolymer co-injected table base, Ø 80mm anodized aluminum column with cross. Base per tavolo H73 a tre razze in metallo sovrastampato con tecnopolimero, colonna in alluminio anodizzato Ø 80mm, crociera.

Top max dimensions / Massima dimensione piano

Available table tops / Piani tavolo disponibili

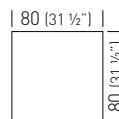
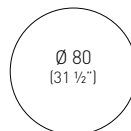

compactop laminated iron

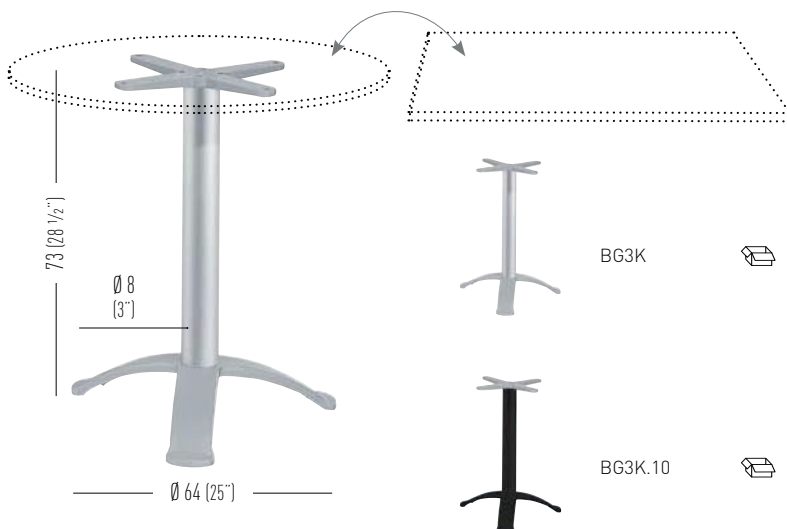

BG3K



0.07m³ / 19.6kg / 2pcs

DKK - kr

1.195

BG3K.10



0.07m³ / 19.6kg / 2pcs

DKK - kr

1.295

BGA3K

H115 3-spur metal-technopolymer co-injected table base, Ø 80mm anodized aluminum column with cross.

Base per tavolo H115 a tre razze in metallo sovrastampato con tecnopolimero, colonna in alluminio anodizzato Ø 80mm, crociera.

Top max dimensions / Massima dimensione piano

Available table tops / Piani tavolo disponibili

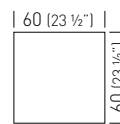
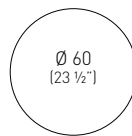

compactop
laminated
iron

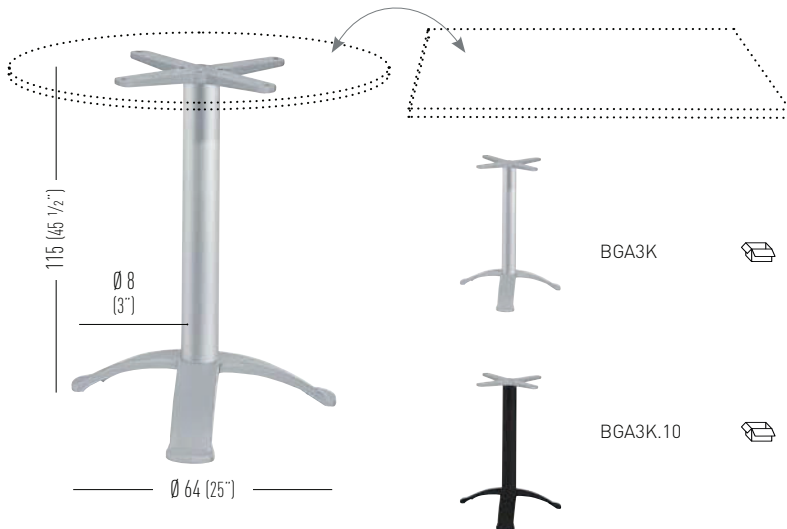

BGA3K 0.12m³ / 21,6kg / 2pcs DKK - kr **1.695**

BGA3K.10 0.12m³ / 21,6kg / 2pcs DKK - kr **1.795**

BPG3K

H73 3-spur metal-technopolymer co-injected table base, Ø 60mm anodized aluminum column with cross.

Base per tavolo H73 a tre razze in metallo sovrastampato con tecnopolimero, colonna in alluminio anodizzato Ø 60mm, crociera.

Top max dimensions / Massima dimensione piano

Available table tops / Piani tavolo disponibili

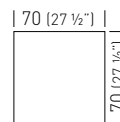
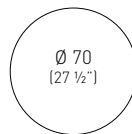

compactop
laminated
iron

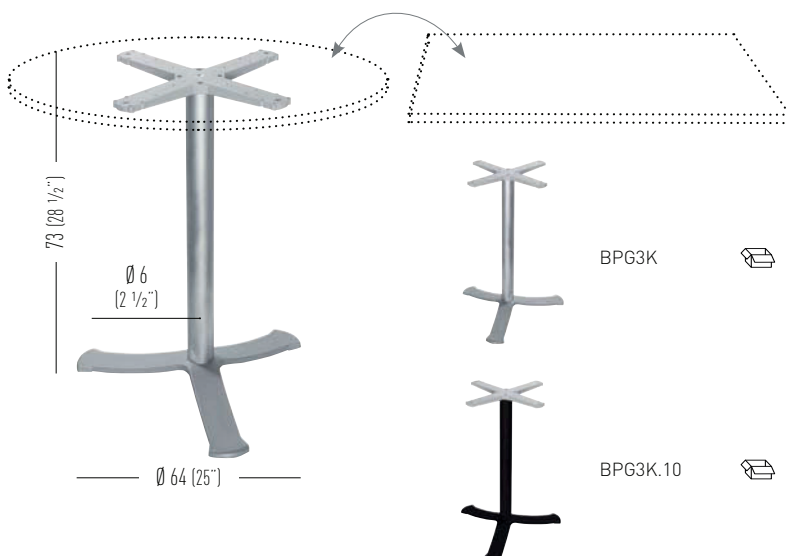

BPG3K 0.07m³ / 14.20kg / 2pcs DKK - kr **1.195**

BPG3K.10 0.07m³ / 14.20kg / 2pcs DKK - kr **1.295**

BG3L

H73 3-spur metal-technopolymer co-injected table base, Ø 80mm anodized aluminum column with cross.

Base per tavolo H73 a tre razze in metallo sovrastampato con tecnopolimero, colonna in alluminio anodizzato Ø 80mm, crociera.

Top max dimensions / Massima dimensione piano

Available table tops / Piani tavolo disponibili

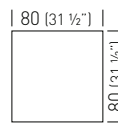
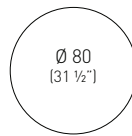

compactop
laminated
iron

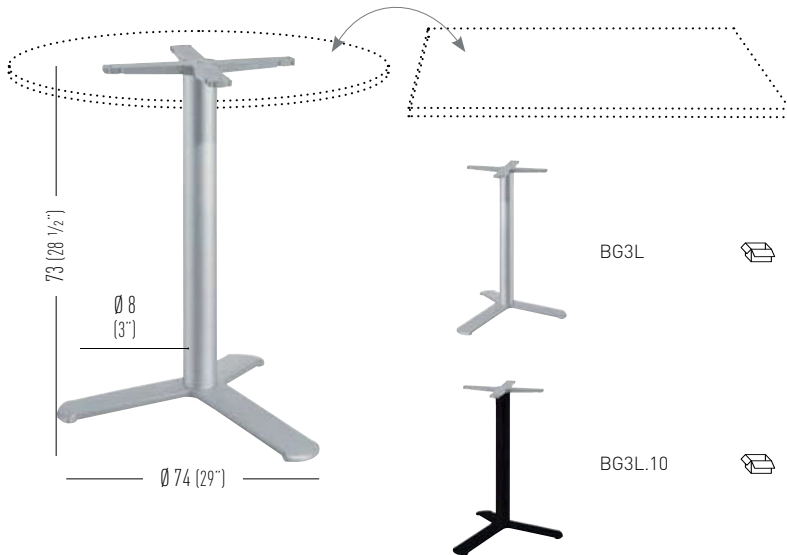

BG3L



0.08m³ / 11kg / 1pcs

DKK - kr

1.295

BG3L.10



0.08m³ / 11kg / 1pcs

DKK - kr

1.495

BGA3L

H110 3-spur metal-technopolymer co-injected table base, Ø 80mm anodized aluminum column with cross.

Base per tavolo H110 a tre razze in metallo sovrastampato con tecnopolimero, colonna in alluminio anodizzato Ø 80mm, crociera.

Top max dimensions / Massima dimensione piano

Available table tops / Piani tavolo disponibili

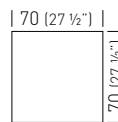
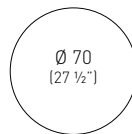

compactop
laminated
iron

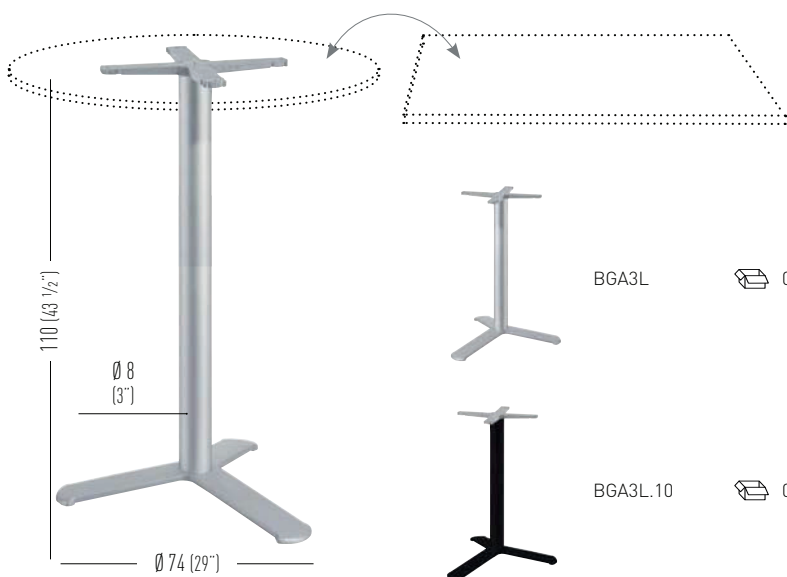

BGA3L



0.12m³ / 23.6kg / 2pcs

DKK - kr

1.695

BGA3L.10



0.12m³ / 23.6kg / 2pcs

DKK - kr

1.795

BG4K

H73 4-spur metal-technopolymer co-injected table base, Ø 80mm anodized aluminum column with cross.

Base per tavolo H73 a quattro razze in metallo sovrastampato con tecnopolimero, colonna in alluminio anodizzato Ø 80mm, crociera.

Top max dimensions / Massima dimensione piano

Available table tops / Piani tavolo disponibili

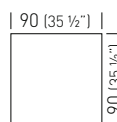
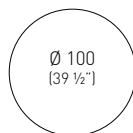

compactop
laminated
iron

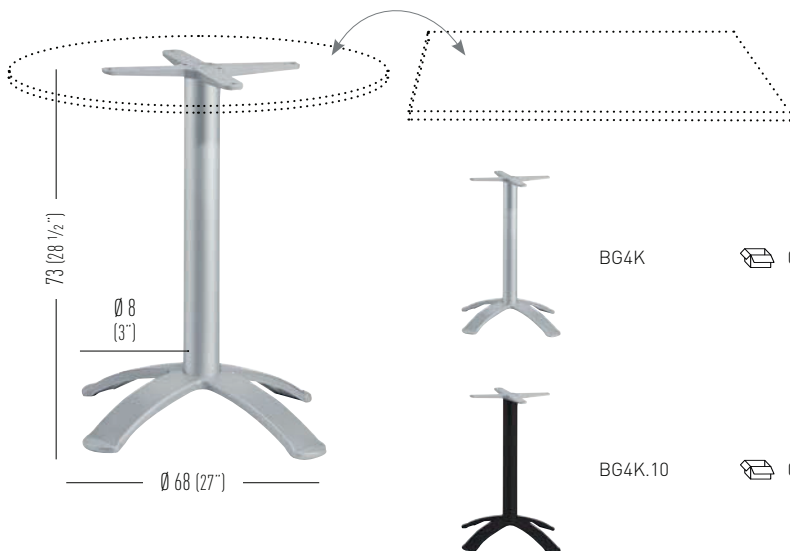

BG4K	0.07m³ / 25kg / 2pcs	DKK - kr	1.295
BG4K.10	0.07m³ / 25kg / 2pcs	DKK - kr	1.395

BGA4K

H115 4-spur metal-technopolymer co-injected table base, Ø 80mm anodized aluminum column with cross.

Base per tavolo H115 a quattro razze in metallo sovrastampato con tecnopolimero, colonna in alluminio anodizzato Ø 80mm, crociera.

Top max dimensions / Massima dimensione piano

Available table tops / Piani tavolo disponibili

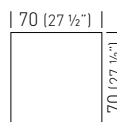
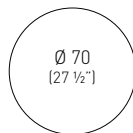

compactop
laminated
iron

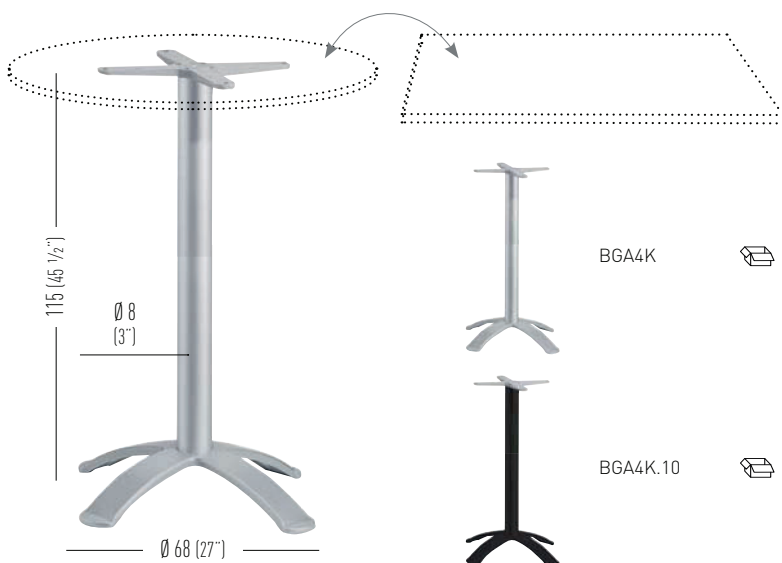

BGA4K	0.11m³ / 26.60kg / 2pcs	DKK - kr	1.895
BGA4K.10	0.11m³ / 26.60kg / 2pcs	DKK - kr	1.995

BG4J

H73 4-spur metal-technopolymer co-injected table base, 80x80mm anodized aluminum column with cross. Base per tavolo H73 a quattro razze in metallo sovrastampato con tecnopolimero, colonna in alluminio anodizzato 80x80mm, crociera.

Top max dimensions / Massima dimensione piano

Available table tops / Piani tavolo disponibili

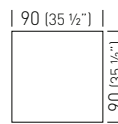
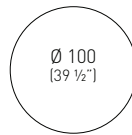

compactop laminated iron

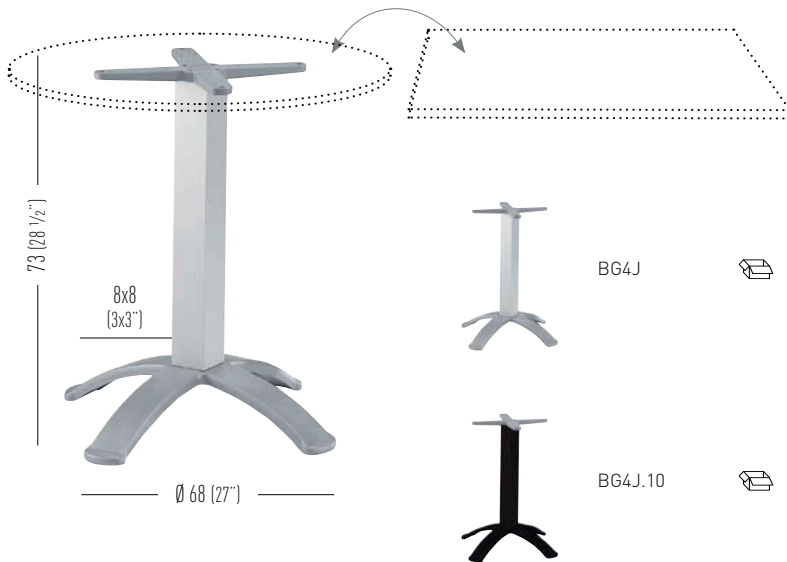

BG4J	0.10m ³ / 25.6kg / 2pcs	DKK - kr	1.395
BG4J.10	0.10m ³ / 25.6kg / 2pcs	DKK - kr	1.495

BGPK

H73 4-spur metal-technopolymer co-injected table base, Ø 80mm anodized aluminum column with flip-top mechanism. Base per tavolo pieghevole H73 a quattro razze in metallo sovrastampato con tecnopolimero, colonna in alluminio anodizzato Ø 80mm.

Top max dimensions / Massima dimensione piano

Available table tops / Piani tavolo disponibili

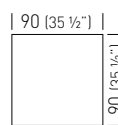
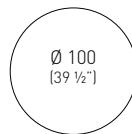

compactop laminated iron

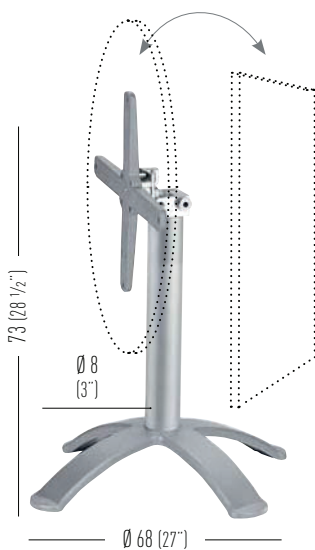

BGPK	0.07m ³ / 27kg / 2pcs	DKK - kr	1.995
BGPK.10	0.07m ³ / 27kg / 2pcs	DKK - kr	2.195

BGPJ

H73 4-spur metal-technopolymer co-injected table base, 80x80mm anodized aluminum column with flip-top mechanism.

Base per tavolo pieghevole H73 a quattro razze in metallo sovrastampato con tecnopolimero, colonna in alluminio anodizzato 80x80mm.

Top max dimensions / Massima dimensione piano

Available table tops / Piani tavolo disponibili

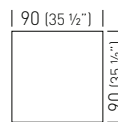
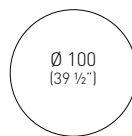

compactop
laminated
iron

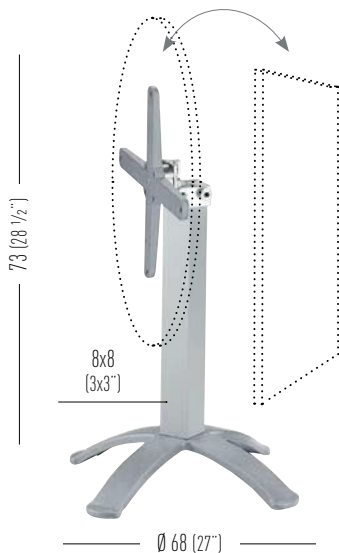

BGPJ 0.10m³ / 27.60kg / 2pcs DKK - kr **2.095**

BGPJ.10 0.10m³ / 27.60kg / 2pcs DKK - kr **2.295**

BPG4K

H73 4-spur metal-technopolymer co-injected table base, Ø 60mm anodized aluminum column with cross.

Base per tavolo H73 a quattro razze in metallo sovrastampato con tecnopolimero, colonna in alluminio anodizzato Ø 60mm, crociera.

Top max dimensions / Massima dimensione piano

Available table tops / Piani tavolo disponibili

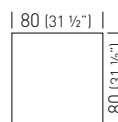
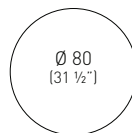

compactop
laminated
iron

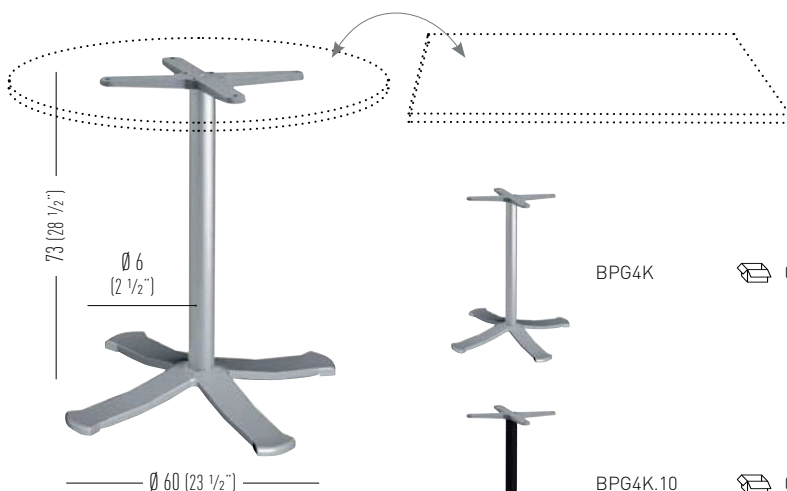

BPG4K 0.07m³ / 17kg / 2pcs DKK - kr **1.295**

BPG4K.10 0.07m³ / 17kg / 2pcs DKK - kr **1.395**

BG4IP

H73 stacking 4-spur metal-technopolymer co-injected table base, Ø 80mm round anodized aluminum column with flip-top mechanism. Adjustable feet.

Base per tavolo pieghevole e accatastabile H73 a quattro razze in metallo sovrastampato con tecnopolimero, colonna in alluminio anodizzato Ø 80mm. Piedini regolabili.

Top max dimensions / Massima dimensione piano

Available table tops / Piani tavolo disponibili

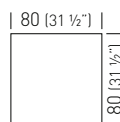
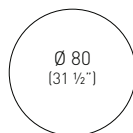

compactop
laminated
iron

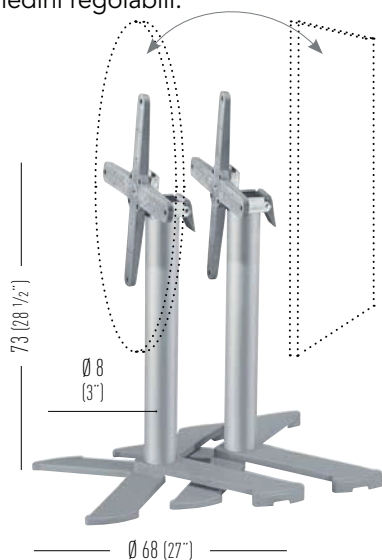

BG4IP



0.07m³ / 20kg / 2pcs

DKK - kr

2.395



BG4IP.10



0.07m³ / 20kg / 2pcs

DKK - kr

2.595

BG2J

H73 double metal-technopolymer co-injected table base, 80x80mm anodized aluminum column with cross.

Base doppia per tavolo H73 in metallo sovrastampato con tecnopolimero, colonna in alluminio anodizzato 80x80mm, crociera.

Top max dimensions / Massima dimensione piano

Available table tops / Piani tavolo disponibili

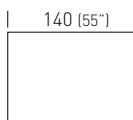

compactop
laminated
iron

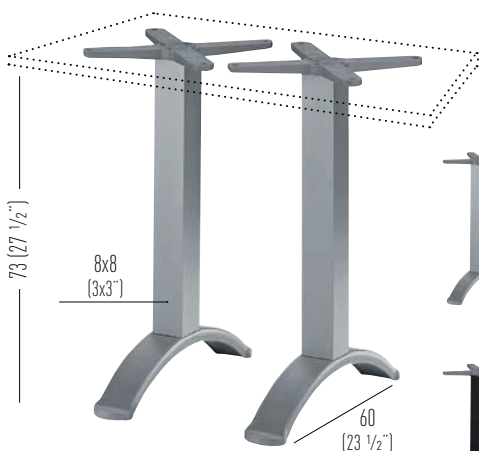

BG2J



0.07m³ / 30kg / 2pcs

DKK - kr

2.095



BG2J.10



0.07m³ / 30kg / 2pcs

DKK - kr

2.295

BTK

H73 round metal-technopolymer co-injected table base, Ø 80mm anodized aluminum column with cross.

Base per tavolo H73 rotonda in metallo sovrastampato con tecnopolimero, colonna in alluminio anodizzato Ø 80mm, crociera.

Top max dimensions / Massima dimensione piano

Available table tops / Piani tavolo disponibili

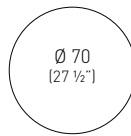

compactop
laminated
iron

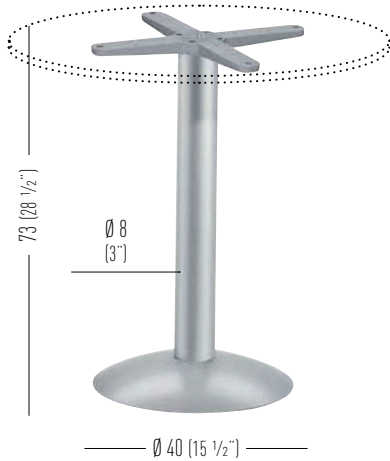

BTK



0.10m³ / 19.60kg / 2pcs

DKK - kr

1.095



BTK.10



0.10m³ / 19.60kg / 2pcs

DKK - kr

1.195

BTAK

H110 round metal-technopolymer co-injected table base, Ø 80mm anodized aluminum column with cross.

Base per tavolo H110 rotonda in metallo sovrastampato con tecnopolimero, colonna in alluminio anodizzato Ø 80mm, crociera.

Top max dimensions / Massima dimensione piano

Available table tops / Piani tavolo disponibili

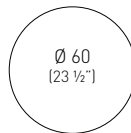

compactop
laminated
iron

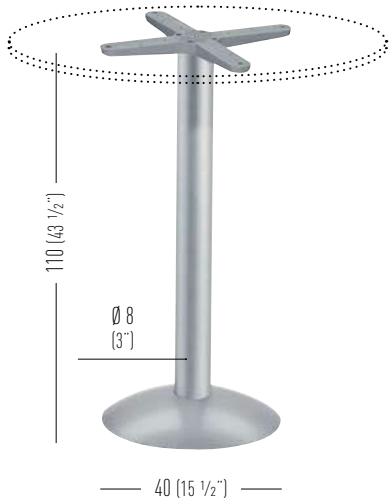

BTAK



0.11m³ / 21.60kg / 2pcs

DKK - kr

1.395



BTAK.10



0.11m³ / 21.60kg / 2pcs

DKK - kr

1.495

BTK54

H73 round metal-technopolymer co-injected table base, Ø 80mm anodized aluminum column with cross.

Base per tavolo H73 rotonda in metallo sovrastampato con tecnopolimero, colonna in alluminio anodizzato Ø 80mm, crociera.

Top max dimensions / Massima dimensione piano

Available table tops / Piani tavolo disponibili

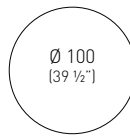

compactop
laminated
iron

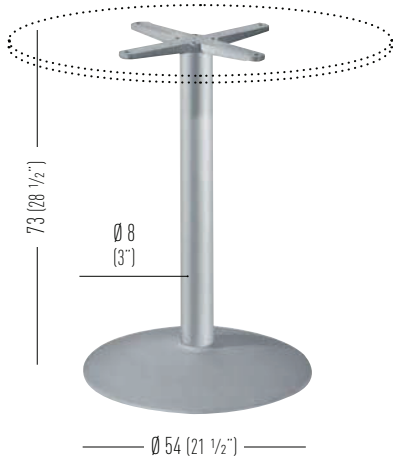

BTK54

0.10m³ / 24.60kg / 2pcs

DKK - kr

1.195

BTK54.10

0.10m³ / 24.60kg / 2pcs

DKK - kr

1.295

BTAK54

H110 round metal-technopolymer co-injected table base, Ø 80mm anodized aluminum column with cross.

Base per tavolo H110 rotonda in metallo sovrastampato con tecnopolimero, colonna in alluminio anodizzato Ø 80mm, crociera.

Top max dimensions / Massima dimensione piano

Available table tops / Piani tavolo disponibili

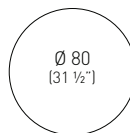

compactop
laminated
iron

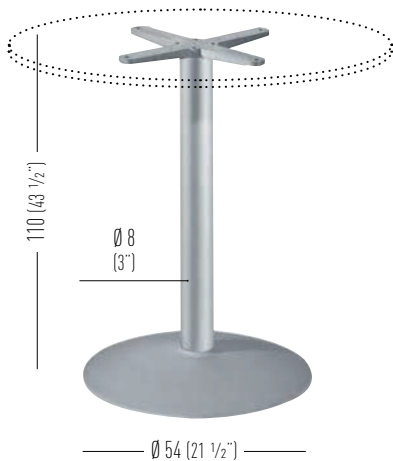

BTAK54

0.11m³ / 25.60kg / 2pcs

DKK - kr

1.595

BTAK54.10

0.11m³ / 25.60kg / 2pcs

DKK - kr

1.695

BRCV

H73 round metal-techno-polymer co-injected table base, Ø 50mm metal painted column with cross.

Base per tavolo H73 rotonda in metallo sovrastampato con tecnopolimero, colonna in metallo verniciato Ø 50mm, crociera.

Top max dimensions / Massima dimensione piano

Available table tops / Piani tavolo disponibili

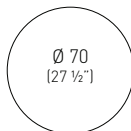

compactop
laminated
iron

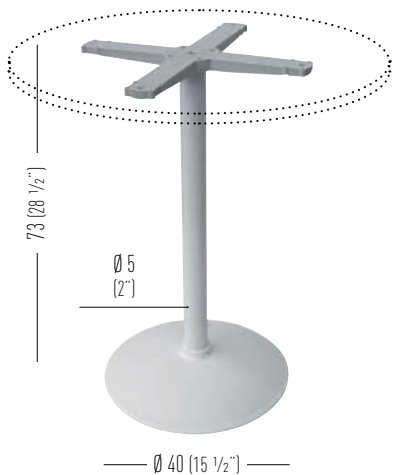

BRCV.00  0.07m³ / 15kg / 2pcs DKK - kr

1.195



BRCV.10  0.07m³ / 15kg / 2pcs DKK - kr

1.195

VENUS ROUND

H73 metal-technopolymer co-injected table base, white color.

Base per tavolo H73 rotonda in metallo sovrastampato con tecnopolimero, colore bianco.

Top max dimensions / Massima dimensione piano

Available table tops / Piani tavolo disponibili

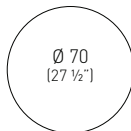



compactop
laminated
iron

Additional weight on request (+3).

Peso supplementare disponibile su richiesta (+3).



BGVR.00  0.2m³ / 6kg / 1pcs DKK - kr
BGVR.00+3kg  0.2m³ / 9kg / 1pcs

1.995
2.295

VENUS SQUARE

H73 metal-technopolymer co-injected table base, white color.
Base per tavolo H73 quadrata in metallo sovrastampato con tecnopolimero, colore bianco.

Top max dimensions / Massima dimensione piano

Available table tops / Piani tavolo disponibili

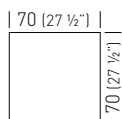

compactop
laminated
iron

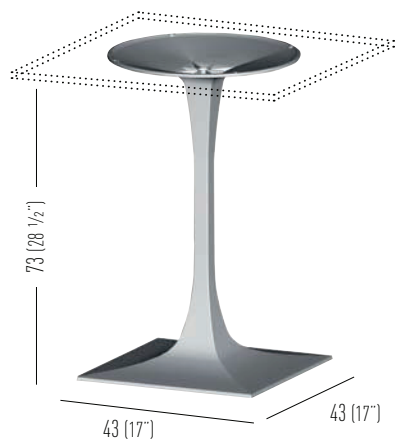

BGVQ.00



0.2m³ / 7kg / 1pcs

DKK - kr

2.095

BRK

H73 round metal-technopolymer co-injected table base, Ø 80mm anodized aluminum column with cross.
Base per tavolo H73 rotonda in metallo sovrastampato con tecnopolimero, colonna in alluminio anodizzato Ø 80mm, crociera.

Top max dimensions / Massima dimensione piano

Available table tops / Piani tavolo disponibili

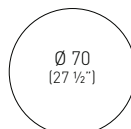

compactop
laminated
iron

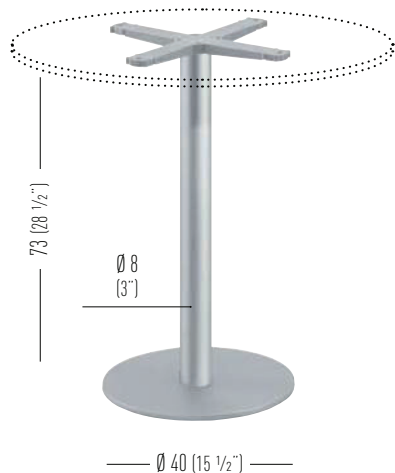

BRK



0.07m³ / 20.60kg / 2pcs

DKK - kr

1.095

BRK.10



0.07m³ / 20.60kg / 2pcs

DKK - kr

1.195

LEI

H73 or H110 4-spur metal-technopolymer co-injected table base, Ø 60mm anodized aluminum column with cross.

Base per tavolo H73 o H110 a quattro razze in metallo sovrastampato con tecnopolimero, colonna in alluminio anodizzato Ø 60mm, crociera.

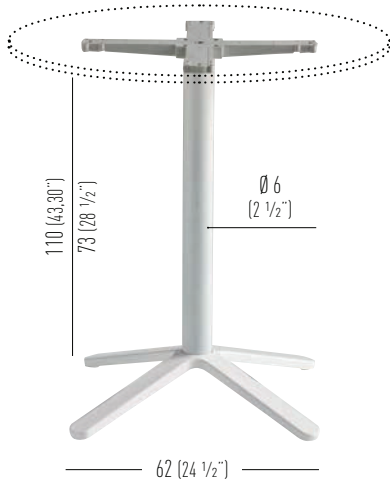

Top max dimensions / Massima dimensione piano

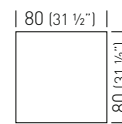
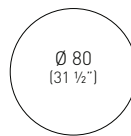

Only H110 / Solo H110

Available table tops / Piani tavolo disponibili

compactop laminated iron



BLEI.00
BLEIA.00



0.07m³ / 8.5kg / 1pcs
0.09m³ / 9kg / 1pcs

DKK - kr

1.295
1.495



BLEI.10
BLEIA.10



0.07m³ / 8.5kg / 1pcs
0.09m³ / 9kg / 1pcs

DKK - kr

1.295
1.495

BQJ

H73 square metal-technopolymer co-injected table base, 80x80mm anodized aluminum column with cross.

Base per tavolo H73 quadrata in metallo sovrastampato con tecnopolimero, colonna in alluminio anodizzato 80x80mm, crociera.

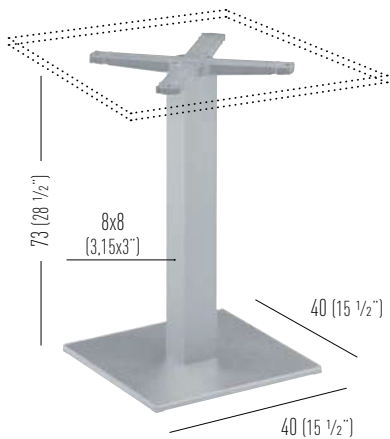

Top max dimensions / Massima dimensione piano

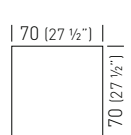

Available table tops / Piani tavolo disponibili

compactop laminated iron



BQJ



0.07m³ / 24.60kg / 2pcs

DKK - kr

1.195

BQJR

Adjustable feet / Piedini regolabili



0.07m³ / 24.60kg / 2pcs

1.395



BQJ.10



0.07m³ / 24.60kg / 2pcs

DKK - kr

1.295

BQJR.10

Adjustable feet / Piedini regolabili



0.07m³ / 24.60kg / 2pcs

1.495

BQAJ

H103 square metal-technopolymer co-injected table base, 80x80mm square anodized aluminum column with cross. Base per tavolo H103 quadrata in metallo sovrastampato con tecnopolimero, colonna quadrata in alluminio anodizzato 80x80mm, crociera.

Top max dimensions / Massima dimensione piano

Available table tops / Piani tavolo disponibili

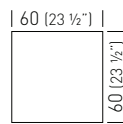

compactop
laminated
iron

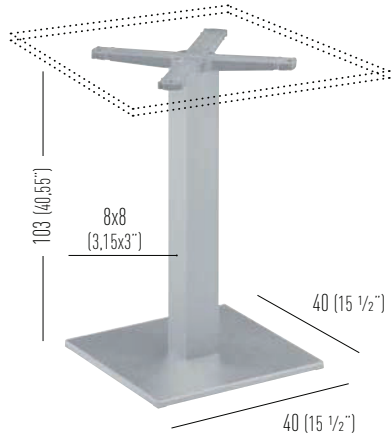

BQAJ 0.08m³ / 25.60kg / 2pcs DKK - kr **1.595**

BQAJR 0.08m³ / 25.60kg / 2pcs **1.795**

Adjustable feet / Piedini regolabili



BQAJ.10 0.08m³ / 25.60kg / 2pcs DKK - kr **1.695**

BQAJR.10 0.08m³ / 25.60kg / 2pcs **1.995**

Adjustable feet / Piedini regolabili

AMICA

H73 4-spur table base collection made of die-cast painted aluminum, Ø60mm polymer-steel co-injected column with cross. Adjustable feet.



Collezione basamenti per tavoli H73 a quattro razze in alluminio pressofuso verniciato, colonna in metallo-polimero Ø60mm, con crociera. Piedini regolabili.

Available table tops / Piani tavolo disponibili

compactop
laminated
iron

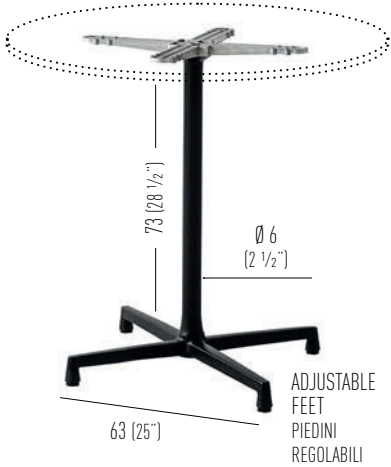

BDA1.00

0.07m³ / 6.5kg / 1pcs

DKK - kr

1.395



BDA1.10

0.07m³ / 6.5kg / 1pcs

1.395

ADJUSTABLE FEET
PIEDINI REGOLABILI

Top max dimensions / Massima dimensione piano

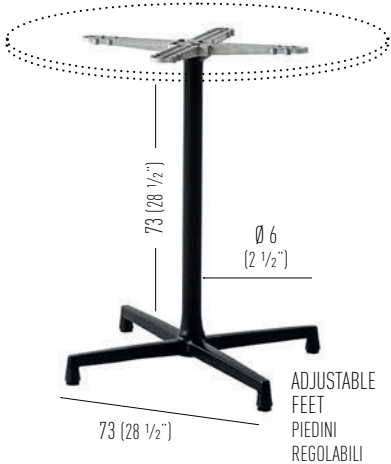
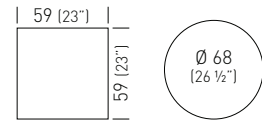

BDA2.00

0.07m³ / 7kg / 1pcs

1.495



BDA2.10

0.07m³ / 7kg / 1pcs

1.495

ADJUSTABLE FEET
PIEDINI REGOLABILI

Top max dimensions / Massima dimensione piano

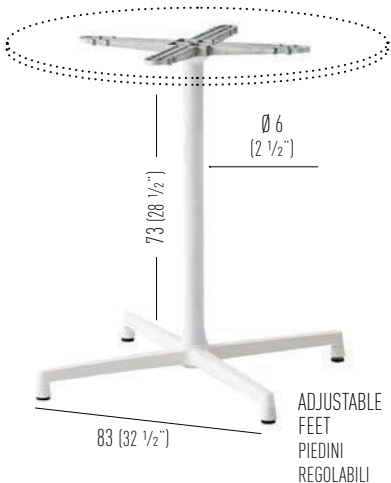
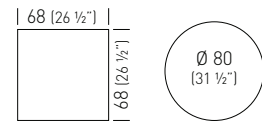

BDA3.00

0.08m³ / 8kg / 1pcs

1.595



BDA3.10

0.08m³ / 8kg / 1pcs

1.595

ADJUSTABLE FEET
PIEDINI REGOLABILI

Top max dimensions / Massima dimensione piano

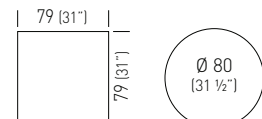

R1

H50-H74-H110 round steel table base,
 Ø 80mm steel column with cross.
 Base per tavolo rotonda in acciaio
 H50, H74 e H110, colonna in acciaio Ø
 80mm, crociera.

Top max dimensions / Massima dimensione piano

Available table tops / Piani tavolo disponibili

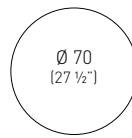

compactop
 laminated
 iron

Finishes for R bases / Finiture per basamenti serie R
 For orders under 10no. surcharge 150 DKK each unit

Polished Steel-Chromed Column / Acciaio Lucido-Colonna Cromata

	H50	BAR1B.A	0.07m³ / 15kg / 1pcs	DKK - kr	1.695
	H74	BAR1.A	0.07m³ / 15kg / 1pcs		1.695
	H110	BAR1A.A	0.09m³ / 17kg / 1pcs		1.995

Satin Steel-Satin Column / Acciaio Satinato-Colonna Satinata

	H50	BAR1B.S	0.07m³ / 15kg / 1pcs	1.795
	H74	BAR1.S	0.07m³ / 15kg / 1pcs	1.795
	H110	BAR1A.S	0.09m³ / 17kg / 1pcs	2.095

White Painted / Verniciata Bianca

	H50	BAR1B.00	0.07m³ / 15kg / 1pcs	1.495
	H74	BAR1.00	0.07m³ / 15kg / 1pcs	1.495
	H110	BAR1A.00	0.09m³ / 17kg / 1pcs	1.795

Black Painted / Verniciata Nera

	H50	BAR1B.10	0.07m³ / 15kg / 1pcs	1.495
	H74	BAR1.10	0.07m³ / 15kg / 1pcs	1.495
	H110	BAR1A.10	0.09m³ / 17kg / 1pcs	1.795

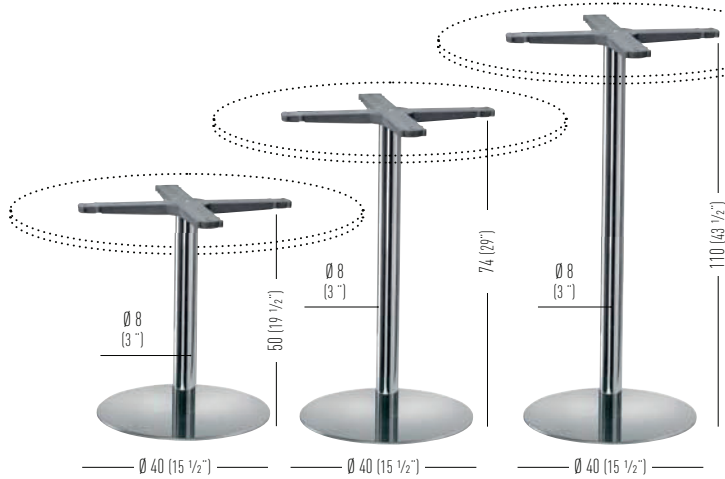

R2

H50-H74-H110 round steel table base,
 Ø 80mm steel column with cross.
 Base per tavolo rotonda in acciaio
 H50, H74 e H110, colonna in acciaio Ø
 80mm, crociera.

Top max dimensions / Massima dimensione piano

Available table tops / Piani tavolo disponibili

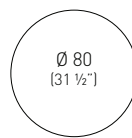

compactop
 laminated
 iron

Finishes for R bases / Finiture per basamenti serie R
 For orders under 10no. surcharge 150DKK each unit

Polished Steel-Chromed Column / Acciaio Lucido-Colonna Cromata

	H50	BAR2B.A	0.07m³ / 18kg / 1pcs	DKK - kr	1.895
	H74	BAR2.A	0.07m³ / 18kg / 1pcs		1.895
	H110	BAR2A.A	0.09m³ / 20kg / 1pcs		2.195

Satin Steel-Satin Column / Acciaio Satinato-Colonna Satinata

	H50	BAR2B.S	0.07m³ / 18kg / 1pcs	2.195
	H74	BAR2.S	0.07m³ / 18kg / 1pcs	2.195
	H110	BAR2A.S	0.09m³ / 20kg / 1pcs	2.495

White Painted / Verniciata Bianca

	H50	BAR2B.00	0.07m³ / 18kg / 1pcs	1.795
	H74	BAR2.00	0.07m³ / 18kg / 1pcs	1.795
	H110	BAR2A.00	0.09m³ / 20kg / 1pcs	2.095

Black Painted / Verniciata Nera

	H50	BAR2B.10	0.07m³ / 18kg / 1pcs	1.795
	H74	BAR2.10	0.07m³ / 18kg / 1pcs	1.795
	H110	BAR2A.10	0.09m³ / 20kg / 1pcs	2.095

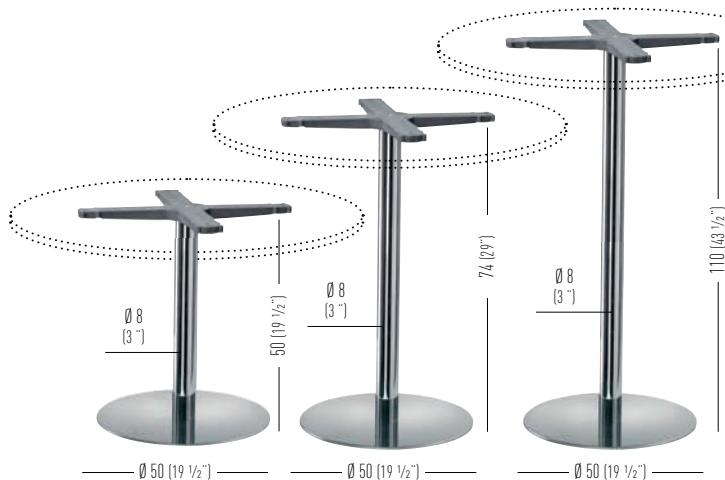

R3

H74-H110 round steel table base, Ø 80mm round steel column with cross.
 Base per tavolo rotonda in acciaio H74 e H110, colonna rotonda in acciaio Ø 80mm, crociera.

Top max dimensions / Massima dimensione piano

Available table tops / Piani tavolo disponibili

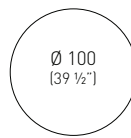

compactop
laminated
iron

Finishes for R bases / Finiture per basamenti serie R

For orders under 10no. surcharge 150 DKK each unit

Polished Steel-Chromed Column / Acciaio Lucido-Colonna Cromata

	H74	BAR3.A	0.07m³ / 21kg / 1pcs	DKK - kr	2.595
	H110	BAR3A.A	0.09m³ / 23kg / 1pcs		

Satin Steel-Satin Column / Acciaio Satinato-Colonna Satinata

	H74	BAR3.S	0.07m³ / 21kg / 1pcs		2.595
	H110	BAR3A.S	0.09m³ / 23kg / 1pcs		

White Painted / Verniciata Bianca

	H74	BAR3.00	0.07m³ / 21kg / 1pcs		1.995
	H110	BAR3A.00	0.09m³ / 23kg / 1pcs		

Black Painted / Verniciata Nera

	H74	BAR3.10	0.07m³ / 21kg / 1pcs		1.995
	H110	BAR3A.10	0.09m³ / 23kg / 1pcs		



V1

H73 round chromed metal table base, Ø 50mm chromed metal column with cross.
 Base per tavolo H73 rotonda in metallo cromato, colonna in metallo cromato Ø 50mm, crociera.

Top max dimensions / Massima dimensione piano

Available table tops / Piani tavolo disponibili

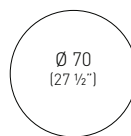

compactop
laminated
iron

Finishes for V1 bases / Finiture per basamenti serie V1

Polished Steel-Chromed Column / Acciaio Lucido-Colonna Cromata

	H73	BV1C	0.1m³ / 15.6kg / 2 pcs	DKK - kr	1.395

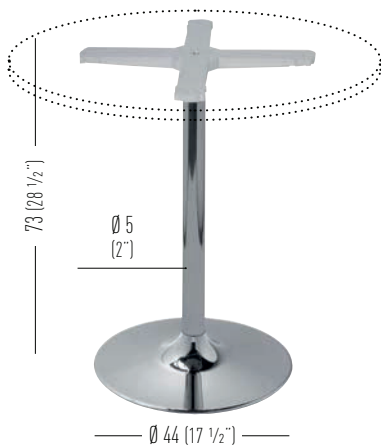

T1 FLOOR FIXING

Floor Fixing H74 round steel table base, Ø 80mm round steel column with cross. Base per tavolo H74 rotonda in metallo per fissaggio a terra, colonna rotonda in metallo Ø 80mm, crociera.

Top max dimensions / Massima dimensione piano

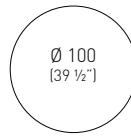

Available table tops / Piani tavolo disponibili

compactop
laminated
iron

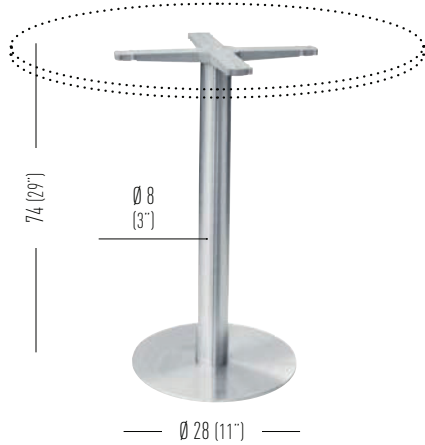

Finishes for T1 bases / Finiture per basamenti serie T1

For orders under 10no. surcharge 150 DKK each unit

Per ordini inferiori ai 10pz + €20,00 ogni unità.

Polished Steel-Chromed Column / Acciaio Lucido-Colonna Cromata



H74

BAT1.S



0.07m³ / 11kg / 1pcs

DKK - kr

1.395

Min. order 5pcs
each code
Ordine min 5pz
per codice

Q1

H50-H74-H110 square steel table base, 80x80mm steel column with cross.

Base per tavolo quadrata in acciaio H50, H74 e H110, colonna in acciaio 80x80mm, crociera.

Top max dimensions / Massima dimensione piano

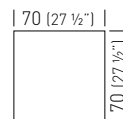

Available table tops / Piani tavolo disponibili

compactop
laminated
iron

Finishes for Q bases / Finiture per basamenti serie Q

For orders under 10no. surcharge 150 DKK each unit

Polished Steel-Chromed Column / Acciaio Lucido-Colonna Cromata



H50

BAQ1B.A



0.07m³ / 17kg / 1pcs

DKK - kr

1.795

H74

BAQ1.A



0.07m³ / 17kg / 1pcs

1.795

H110

BAQ1A.A



0.09m³ / 19kg / 1pcs

2.095

Satin Steel-Satin Column / Acciaio Satinato-Colonna Satinata



H50

BAQ1B.S



0.07m³ / 17kg / 1pcs

1.895

H74

BAQ1.S



0.07m³ / 17kg / 1pcs

1.895

H110

BAQ1A.S



0.09m³ / 19kg / 1pcs

2.295

White Painted / Verniciata Bianca



H50

BAQ1B.00



0.07m³ / 17kg / 1pcs

1.495

H74

BAQ1.00



0.07m³ / 17kg / 1pcs

1.495

H110

BAQ1A.00



0.09m³ / 19kg / 1pcs

1.795

Black Painted / Verniciata Nera



H50

BAQ1B.10



0.07m³ / 17kg / 1pcs

1.495

H74

BAQ1.10



0.07m³ / 17kg / 1pcs

1.495

H110

BAQ1A.10



0.09m³ / 19kg / 1pcs

1.795

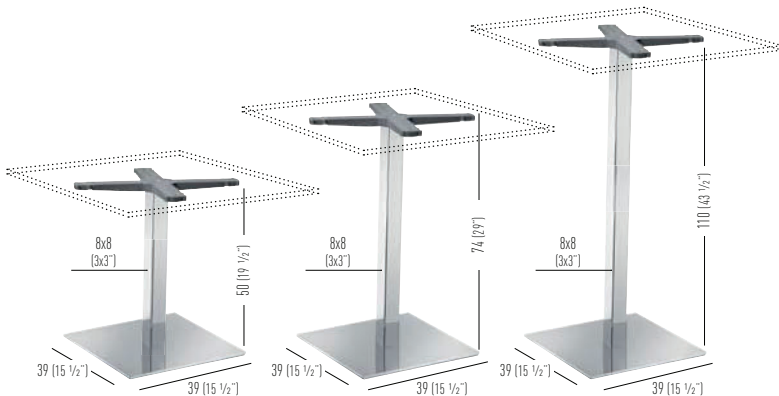

Q2

H50-H74-H110 square steel table base, 80x80mm steel column with cross.
 Base per tavolo quadrata in acciaio H50, H74 e H110, colonna in acciaio 80x80mm, crociera.

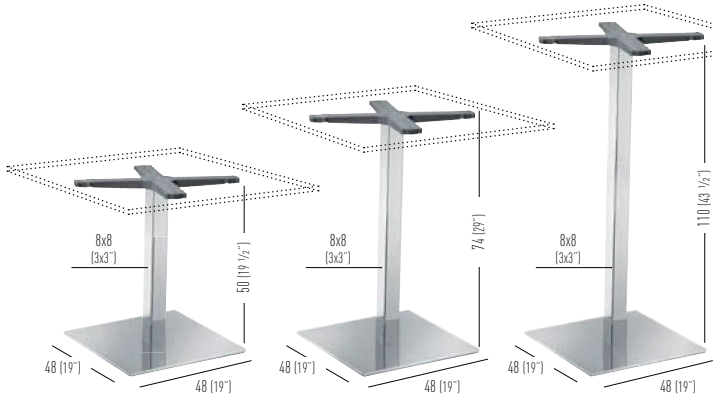

Top max dimensions / Massima dimensione piano

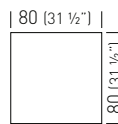

Available table tops / Piani tavolo disponibili

compactop
laminated
iron

Finishes for Q bases / Finiture per basamenti serie Q

For orders under 10no. surcharge 150 DKK each unit

Polished Steel-Chromed Column / Acciaio Lucido-Colonna Cromata

	H50	BAQ2B.A	0.07m³ / 18kg / 1pcs	DKK - kr	2.295
	H74	BAQ2.A	0.07m³ / 18kg / 1pcs		2.295
	H110	BAQ2A.A	0.09m³ / 20kg / 1pcs		2.595

Satin Steel-Satin Column / Acciaio Satinato-Colonna Satinata

	H50	BAQ2B.S	0.07m³ / 18kg / 1pcs	2.295
	H74	BAQ2.S	0.07m³ / 18kg / 1pcs	2.295
	H110	BAQ2A.S	0.09m³ / 20kg / 1pcs	2.595

White Painted / Verniciata Bianca

	H50	BAQ2B.00	0.07m³ / 18kg / 1pcs	1.895
	H74	BAQ2.00	0.07m³ / 18kg / 1pcs	1.895
	H110	BAQ2A.00	0.09m³ / 20kg / 1pcs	2.195

Black Painted / Verniciata Nera

	H50	BAQ2B.10	0.07m³ / 18kg / 1pcs	1.895
	H74	BAQ2.10	0.07m³ / 18kg / 1pcs	1.895
	H110	BAQ2A.10	0.09m³ / 20kg / 1pcs	2.195

Q3

H74-H110 square steel table base, 80x80mm steel column with cross.
 Base per tavolo quadrata in acciaio H74 e H110, colonna in acciaio 80x80mm, crociera.

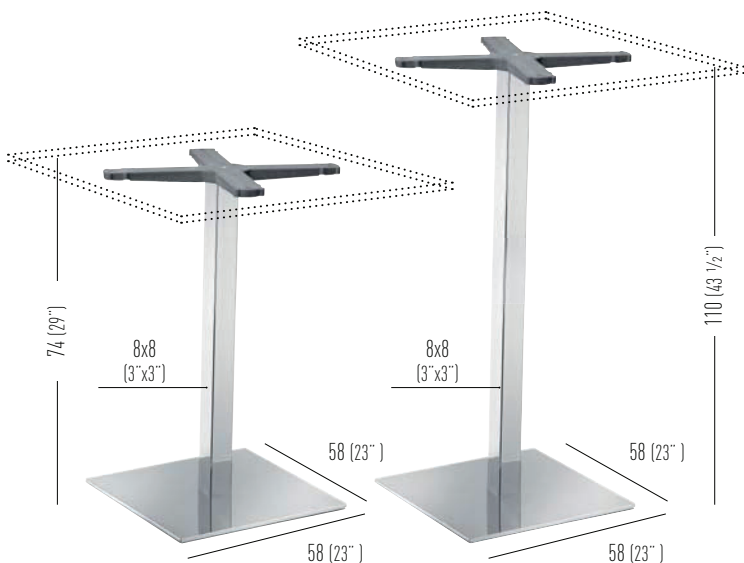

Top max dimensions / Massima dimensione piano

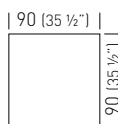

Available table tops / Piani tavolo disponibili

compactop
laminated
iron

Finishes for Q bases / Finiture per basamenti serie Q

For orders under 10no. surcharge 150 DKK each unit

Polished Steel-Chromed Column / Acciaio Lucido-Colonna Cromata

	H74	BAQ3.A	0.07m³ / 23kg / 1pcs	DKK - kr	2.795
	H110	BAQ3A.A	0.09m³ / 25kg / 1pcs		3.095

Satin Steel-Satin Column / Acciaio Satinato-Colonna Satinata

	H74	BAQ3.S	0.07m³ / 23kg / 1pcs	2.795
	H110	BAQ3A.S	0.09m³ / 25kg / 1pcs	3.095

White Painted / Verniciata Bianca

	H74	BAQ3.00	0.07m³ / 23kg / 1pcs	2.095
	H110	BAQ3A.00	0.09m³ / 25kg / 1pcs	2.395

Black Painted / Verniciata Nera

	H74	BAQ3.10	0.07m³ / 23kg / 1pcs	2.095
	H110	BAQ3A.10	0.09m³ / 25kg / 1pcs	2.395

D2

H74-H110 double steel table base,
80x80mm steel columns with cross.
Base doppia per tavolo H74 e H110 in
acciaio, colonne in acciaio 80x80mm,
crociere.

Top max dimensions / Massima dimensione piano

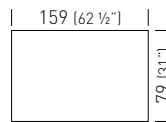

Available table tops / Piani tavolo disponibili

compactop
laminated
iron

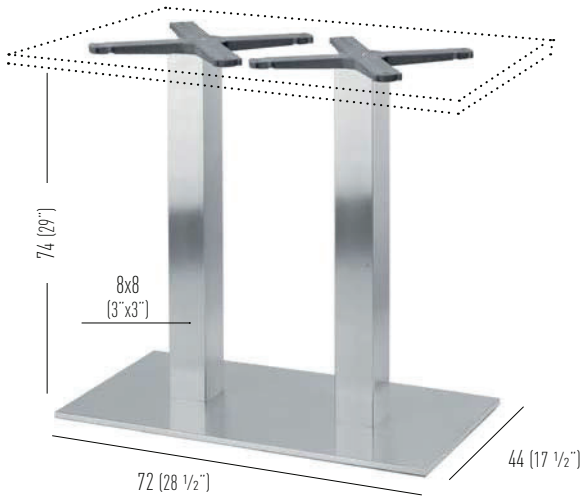

Finishes for D2 bases / Finiture per basamenti serie D2

Polished Steel-Chromed Column / Acciaio Lucido-Colonna Cromata



H74

BAD2.A



0.22m³ / 32kg / 1pcs DKK - kr

3.295

Satin Steel-Satin Column / Acciaio Satinato-Colonna Satinata



H74

BAD2.S



0.22m³ / 32kg / 1pcs

3.495

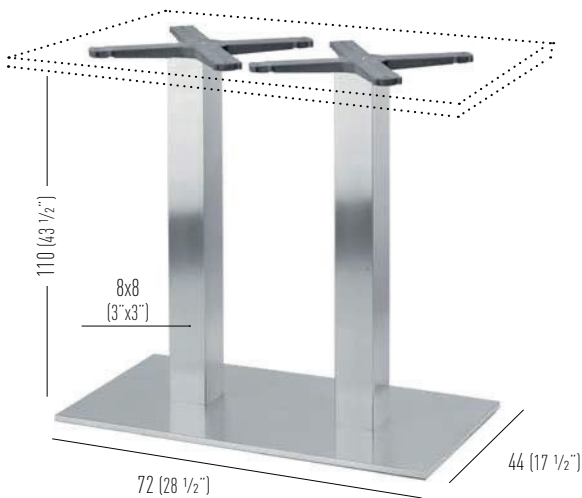

Polished Steel-Chromed Column / Acciaio Lucido-Colonna Cromata



H110

BAD2.A.A



0.22m³ / 35kg / 1pcs DKK - kr

3.695

Satin Steel-Satin Column / Acciaio Satinato-Colonna Satinata



H110

BAD2.A.S



0.22m³ / 35kg / 1pcs

3.895

ALFIE

H72 4-Spur table base collection made of painted steel, Ø100mm metal painted column with cross. Adjustable feet. Collezione basamenti per tavoli, H72, quattro razze in acciaio verniciato, colonna in metallo verniciato Ø100mm con crociera. Piedini regolabili.



Available top sizes / Dimensioni piano disponibili

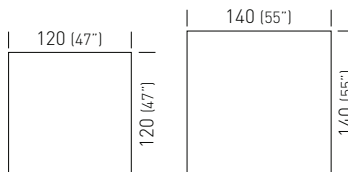

Available table tops / Piani tavolo disponibili

laminated

Black Painted / Verniciata Nera



BALF.10



0.13m³ / 15kg / 1pcs

DKK - kr

3.595

TATAMI

H74-H110 round steel table base, Ø 80mm steel similar wood-effect column with cross.

Base per tavolo rotonda in acciaio H74
e H110, colonna finto legno Ø 80mm,
crociera.

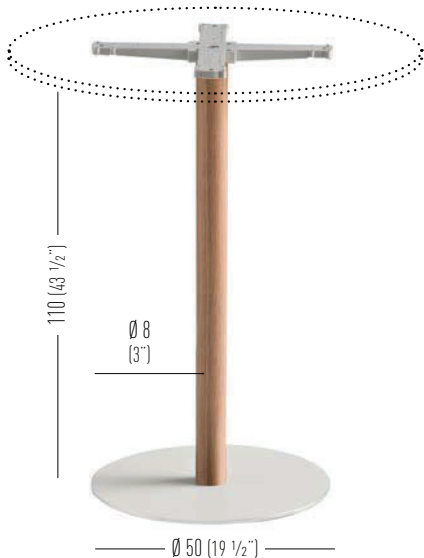
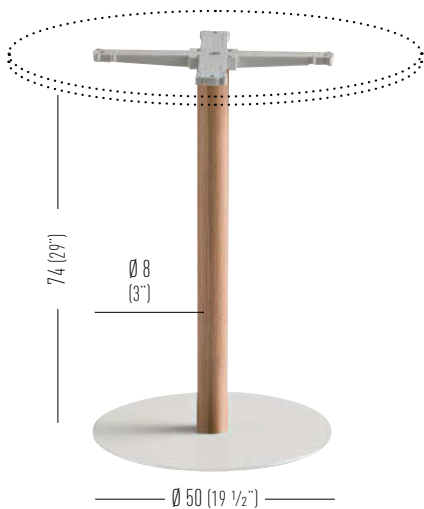

Top max dimensions / Massima dimensione piano

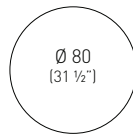

Available table tops / Piani tavolo disponibili

compactop
laminated
iron

Finishes for TATAMI bases / Finiture per basamenti serie Tatami

For orders under 10no. surcharge 150 DKK each unit

Polished Steel / Acciaio Lucido

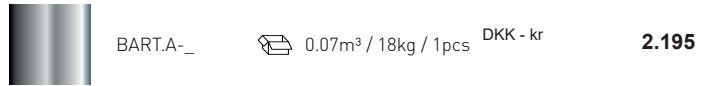

Satin Steel / Acciaio Satinato

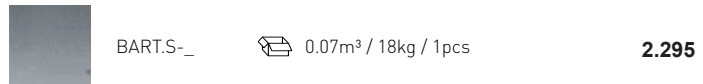

White Painted / Verniciata Bianca

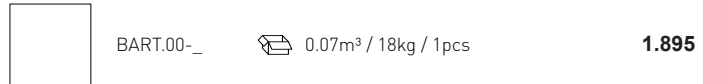

Black Painted / Verniciata Nera

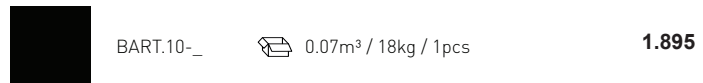

Finishes for Tatami columns / Finiture per colonne serie Tatami



F
Natural Beech effect
Faggio Naturale finto legno



RN
Oak effect
Rovere finto legno

Finishes for TATAMI bases / Finiture per basamenti serie Tatami For orders
under 10no. surcharge 150 DKK each unit

Polished Steel / Acciaio Lucido

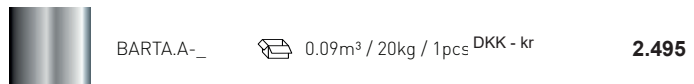

Satin Steel / Acciaio Satinato



White Painted / Verniciata Bianca

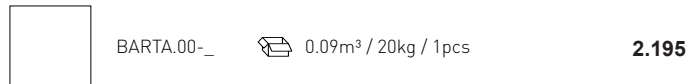

Black Painted / Verniciata Nera

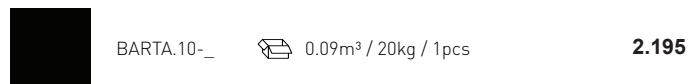

Finishes for Tatami columns / Finiture per colonne serie Tatami



F
Natural Beech effect
Faggio Naturale finto legno



RN
Oak effect
Rovere finto legno

LOL3 BASE

H49-H74 3-spur table base collection, made of steel treated for outdoor use, matt finish.

Basamento per tavolo H49-H74 a tre razze, realizzato in acciaio trattato per esterni, finitura opaca.



Only for the base
Solo per il basamento

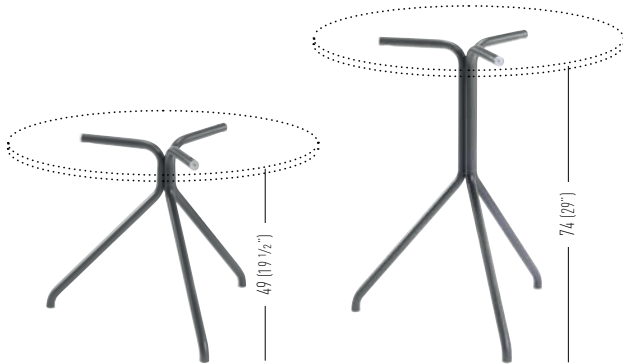

Top max dimensions / Massima dimensione piano

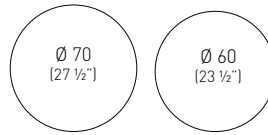

Available table tops / Piani tavolo disponibili

laminated

Frame Color / Colore Struttura

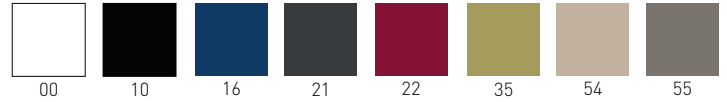

H49 BLOL3.__/H49 0.17m³ / 3.5kg / 1pc
H74 BLOL3.__/H74 0.24m³ / 4.1kg / 1pc

DKK - kr

1.295

1.595

Min. order 10pcs
each code
Ordine min 10pz
per codice

Top max dimensions / Massima dimensione piano

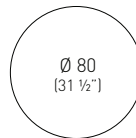

Available table tops / Piani tavolo disponibili

laminated



Only for the base
Solo per il basamento

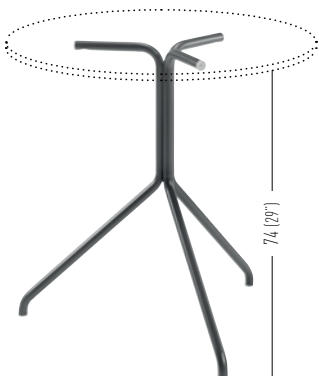

Frame Color / Colore Struttura

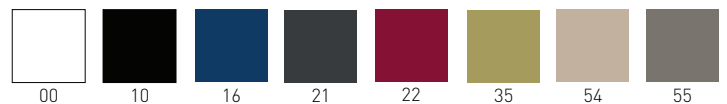

H74L BLOL3L.__/H74 0.43m³ / 4.2Kg / 1pc

DKK - kr

2.295

Min. order 10pcs
each code
Ordine min 10pz
per codice

LOL4 BASE

H74 4-spur table base collection, made of steel treated for outdoor use, matt finish. Basamento per tavolo H74 a quattro razze, realizzato in acciaio trattato per esterni, finitura opaca.



Only for the base
Solo per il basamento

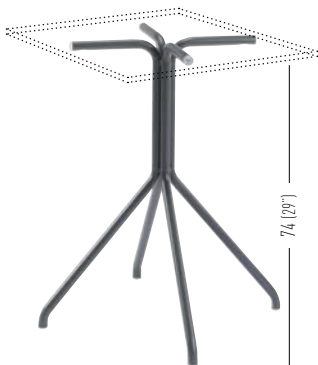

Top max dimensions / Massima dimensione piano

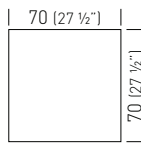

Available table tops / Piani tavolo disponibili

compactop
laminated

Frame Color / Colore Struttura

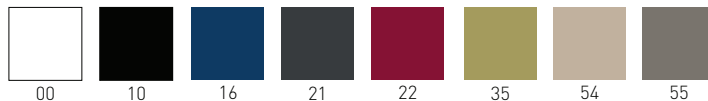

00

10

16

21

22

35

54

55

H74

BLOL4._/H74



0.24m³ / 4.9kg / 1pc

DKK - kr

1.595

Min. order 10pcs
each code
Ordine min 10pz
per codice

Top max dimensions / Massima dimensione piano

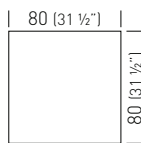

Available table tops / Piani tavolo disponibili

compactop
laminated

Frame Color / Colore Struttura



00

10

16

21

22

35

54

55

H74L

BLOL4L._/H74



0.35m³ / 5.2kg / 1pc

DKK - kr

2.095

Min. order 10pcs
each code
Ordine min 10pz
per codice



Only for the base
Solo per il basamento

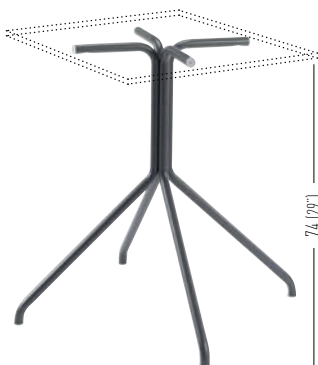

LOL PLUS BASE

The Lol Plus table bases collection is made of steel, the cross is made in die cast aluminum, and provided with flip-top joint. The shape of the base and the flip-top mechanism allow the table to easily fold and stack, space-saving. The available colour palette is common to many Gaber seating collections, guaranteeing tone-on-tone colour co-ordination throughout designed settings rather than lively contrasts, defining various colour combinations between bases, tops and seating.

La Collezione di basamenti Lol Plus è realizzata in acciaio, la crociera è realizzata in presso fusione di alluminio, ed è dotata di giunto per la rotazione del piano. La forma della base e la meccanica che permette la rotazione del piano in posizione verticale, rendono il tavolo facilmente accatastabile in spazi ridotti. La palette di colori disponibile è comune a molte collezioni di sedute Gaber, garantendo abbinamenti tono su tono degli ambienti progettati, piuttosto che vivaci contrasti, definendo diverse combinazioni di colori tra basi, piani e sedute.

Top max dimensions / Massima dimensione piano

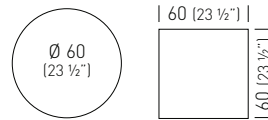

Available table tops / Piani tavolo disponibili

compactop
laminated

Frame Color / Colore Struttura

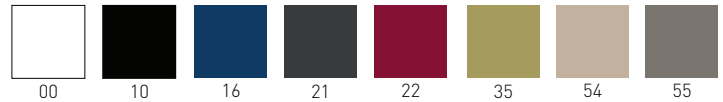

00

10

16

21

22

35

54

55

H74

BLLOLP._/H74



0.24m3 / 5.3kg / 1pc

DKK - kr

2.295

Min. order 10pcs
each code
Ordine min 10pz
per codice



Only for the base
Solo per il basamento

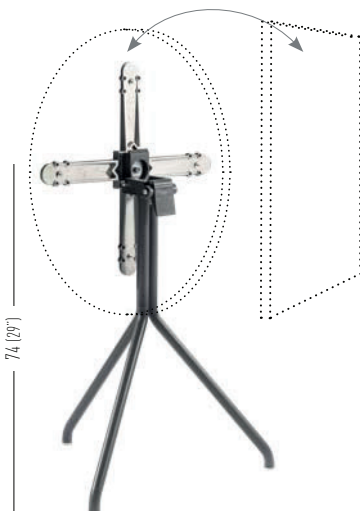

BRISTOL BASE

4-spur H74 table base in epoxy powder coated steel treated for outdoor use, and equipped with adjustable feet.

Basamento per tavolo H74 con struttura a quattro razze, dotato di piedini regolabili, in acciaio verniciato a polveri epossidiche con trattamento per esterno.

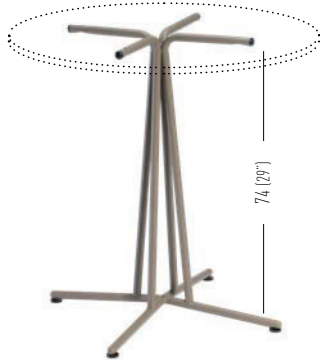

Top max dimensions / Massima dimensione piano

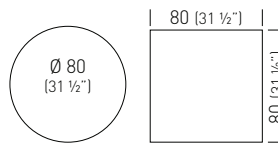

Available table tops / Piani tavolo disponibili

compactop
laminated

Frame Color / Colore Struttura

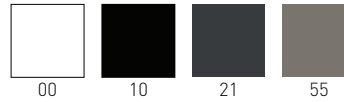

H74 BBRS_/_/H74  0.23m3 / 5.5kg / 1pc DKK - kr

1.895

Minimum order 20 pcs each code, unless combined with Gaber table tops.
Ordine minimo 20 pezzi per codice, se non abbinato a piani Gaber.

GLITTER BASE

H74 and H105 tripod table bases in epoxy powder coated steel with outdoor treatment.

Basamento per tavolo H74-H105 con struttura a tre punti di appoggio, realizzato in acciaio verniciato a polveri epossidiche con trattamento per esterno.



Top max dimensions / Massima dimensione piano

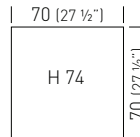
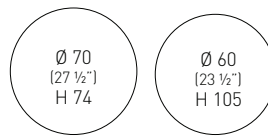

Available table tops / Piani tavolo disponibili

compactop
laminated



Frame Color / Colore Struttura

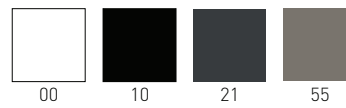

H74	BGLT.__/H74	0.18m3 / 2.9kg / 1pc	DKK - kr	1.595
H105	BGLT.__/H105	0.18m3 / 3.55kg / 1pc		1.795

Minimum order 20 pcs each code, unless combined with Gaber table tops.
Ordine minimo 20 pezzi per codice, se non abbinato a piani Gaber.

OFFICE & WORKSPACES *System*

Workstation 2027



This office furniture collection is intended for modern workplaces. It is distinguished by simple and rational worktop lines as well as slender and resistant support frames with a trestle shape. The service cabinets are suspended, a feature designed for easy and modern cleaning. The desks can be equipped with high-performance sound-absorbing screens, to improve privacy and the general acoustics of the workplace. The assembly systems have been especially designed to be fast and safe.

Programma d'arredo destinato ad uffici moderni con piani di lavoro dalle linee semplici e razionali, strutture di sostegno con forma a cavalletto per essere snelle e resistenti. I mobili di servizio sono sospesi, caratteristica pensata per una semplice e moderna pulizia automatica. Le scrivanie possono essere dotate di schermi divisorii per migliorare la privacy e l'acustica. I sistemi di assemblaggio sono veloci e sicuri.

Finishings / Finiture

Melamine Laquered Cabinets Colors
(Antibacterial water-base laquering)
Colori Laccati Mobili Melaminico
(Laccatura antibatterica a base acqua)



Frame colors
Colori struttura



Melamine Cabinets Color
Colore Mobili Melaminico



Laminated top color
ABS Edge
Colori piano laminato
Bordo ABS



White Matte Laquered Neve (00) / Black Matte Laquered (10) / Blue Matte Laquered 5003 (16) / Grey Matte Laquered Antracite (21) / Bordeaux Matte Laquered 3004 (22)
Lime Matte Laquered Limone (35) / Mineral Grey Matte Laquered 7006 (55)



Option: Cod. 1101
Cable Routing Option, anodized Aluminum 8x8 cm, black brush
Opzione Passacavi, Alluminio anodizzato 8x8 cm spazzolina nera
DKK 750



Option: Cod. ACCV030...
Metal Fairlead Solution
Tubo metallico passacavi
DKK 450

WORKSTATION 2027 DX VERSION 180



Workstation with 2027 structure, cabinet consisting of module with sliding doors and lock, 1 partition and 1 shelf per compartment, open module with 1 shelf. Straight desktop white colour, thickness 22mm.

Stazione di lavoro con struttura 2027, mobile composto da modulo con ante scorrevoli e serratura, 1 tramezza e 1 ripiano per vano, modulo a giorno con 1 ripiano. Piano scrivania di lavoro diritta di colore bianco, spessore 22mm.

Melamine Laquered Cabinets Colors
Colori Laccati Mobili Melaminico



Frame colors
Colori struttura

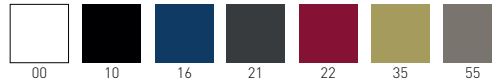

Melamine Cabinets Color
Colore Mobili Melaminico



Laminated top color
Colori piano laminato

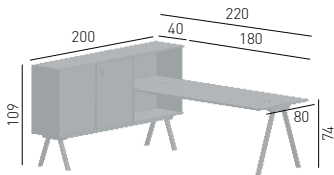

Unassembled structure, individual modules assembled.
Struttura non assemblata, singoli moduli assemblati.



1,07 m³
114,5 kg.

Finishing & Codes / Finiture e Codici

Melamine Cabinets / Mobili in Melaminico

cod. **WRKMD1D.00-00/PK__**

Melamine Laquered Cabinets / Mobili in Melaminico Laccato

cod. **WRKQD1D.__-00/PK__**

DKK - kr

17.395

22.995

WORKSTATION 2027 SX VERSION 180



Workstation with 2027 structure, cabinet consisting of module with sliding doors and lock, 1 partition and 1 shelf per compartment, open module with 1 shelf. Straight desktop white colour, thickness 22mm.

Stazione di lavoro con struttura 2027, mobile composto da modulo con ante scorrevoli e serratura, 1 tramezza e 1 ripiano per vano, modulo a giorno con 1 ripiano. Piano scrivania di lavoro diritta di colore bianco, spessore 22mm.

Melamine Laquered Cabinets Colors
Colori Laccati Mobili Melaminico



Frame colors
Colori struttura



Melamine Cabinets Color
Colore Mobili Melaminico



Laminated top color
Colori piano laminato

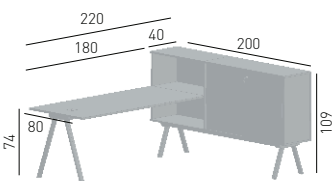

Unassembled structure, individual modules assembled.
Struttura non assemblata, singoli moduli assemblati.



1,07 m³
114,5 kg.

Finishing & Codes / Finiture e Codici

Melamine Cabinets / Mobili in Melaminico

cod. **WRKMD1S.00-00/PK__**

Melamine Laquered Cabinets / Mobili in Melaminico Laccato

cod. **WRKQD1S.__-00/PK__**

DKK - kr

17.395

22.995

WORKSTATION 2027 DX VERSION 240



Workstation with 2027 structure, cabinet consisting of module with sliding doors and lock, 1 partition and 1 shelf per compartment, open module with 1 shelf. Straight desktop white colour, thickness 22mm.

Stazione di lavoro con struttura 2027, mobile composto da modulo con ante scorrevoli e serratura, 1 tramezza e 1 ripiano per vano, modulo a giorno con 1 ripiano. Piano scrivania di lavoro diritta di colore bianco, spessore 22mm.

Melamine Laquered Cabinets Colors
Colori Laccati Mobili Melaminico



Frame colors
Colori struttura



Melamine Cabinets Color
Colore Mobili Melaminico



Laminated top color
Colori piano laminato

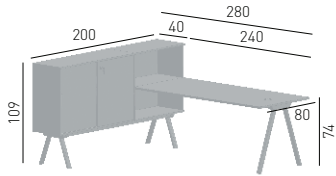

Unassembled structure, individual modules assembled.
Struttura non assemblata, singoli moduli assemblati.



1,12 m³
124,5 kg.

Finishing & Codes / Finiture e Codici

Melamine Cabinets / Mobili in Melaminico

cod. **WRKMD2D.00-00/PK__**

Melamine Laquered Cabinets / Mobili in Melaminico Laccato

cod. **WRKQD2D.__-00/PK__**

DKK - kr

19.095

24.595

WORKSTATION 2027 SX VERSION 240



Workstation with 2027 structure, cabinet consisting of module with sliding doors and lock, 1 partition and 1 shelf per compartment, open module with 1 shelf. Straight desktop white colour, thickness 22mm.

Stazione di lavoro con struttura 2027, mobile composto da modulo con ante scorrevoli e serratura, 1 tramezza e 1 ripiano per vano, modulo a giorno con 1 ripiano. Piano scrivania di lavoro diritta di colore bianco, spessore 22mm.

Melamine Laquered Cabinets Colors
Colori Laccati Mobili Melaminico



Frame colors
Colori struttura



Melamine Cabinets Color
Colore Mobili Melaminico



Laminated top color
Colori piano laminato

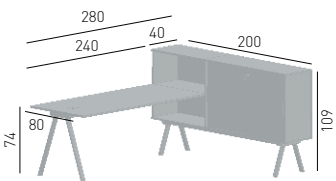

Unassembled structure, individual modules assembled.
Struttura non assemblata, singoli moduli assemblati.



1,12 m³
124,5 kg.

Finishing & Codes / Finiture e Codici

Melamine Cabinets / Mobili in Melaminico

cod. **WRKMD2S.00-00/PK__**

Melamine Laquered Cabinets / Mobili in Melaminico Laccato

cod. **WRKQD2S.__-00/PK__**

DKK - kr

19.095

24.595

WORKSTATION 2027 DX L-VERSION 180



Workstation with 2027 structure, cabinet consisting of module with sliding doors and lock, 1 partition and 1 shelf per compartment, open module with 1 shelf. Wraparound work desktop white colour, thickness 22mm.

Stazione di lavoro con struttura 2027, mobile composto da modulo con ante scorrevoli e serratura, 1 tramezza e 1 ripiano per vano, modulo a giorno con 1 ripiano. Piano scrivania di lavoro avvolgente di colore bianco, spessore 22mm.

Melamine Laquered Cabinets Colors
Colori Laccati Mobili Melaminico

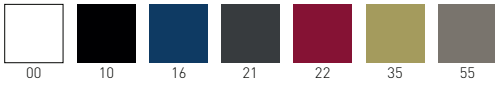

Frame colors
Colori struttura



Melamine Cabinets Color
Colore Mobili Melaminico



Laminated top color
Colori piano laminato

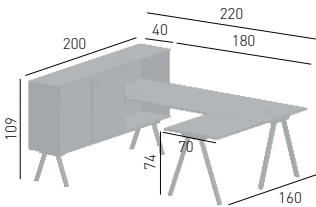

Unassembled structure, individual modules assembled.
Struttura non assemblata, singoli moduli assemblati.



1,12 m³
129,5 kg.

Finishing & Codes / Finiture e Codici

Melamine Cabinets / Mobili in Melaminico

cod. **WRKML1D.00-00/PK__**

Melamine Laquered Cabinets / Mobili in Melaminico Laccato

cod. **WRKQL1D.__-00/PK__**

DKK - kr

20.195

25.295

WORKSTATION 2027 SX L-VERSION 180



Workstation with 2027 structure, cabinet consisting of module with sliding doors and lock, 1 partition and 1 shelf per compartment, open module with 1 shelf. Wraparound work desktop white colour, thickness 22mm.

Stazione di lavoro con struttura 2027, mobile composto da modulo con ante scorrevoli e serratura, 1 tramezza e 1 ripiano per vano, modulo a giorno con 1 ripiano. Piano scrivania di lavoro avvolgente di colore bianco, spessore 22mm.

Melamine Laquered Cabinets Colors
Colori Laccati Mobili Melaminico



Frame colors
Colori struttura



Melamine Cabinets Color
Colore Mobili Melaminico



Laminated top color
Colori piano laminato

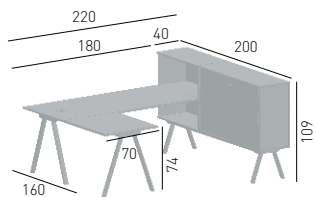

Unassembled structure, individual modules assembled.
Struttura non assemblata, singoli moduli assemblati.



1,12 m³
129,5 kg.

Finishing & Codes / Finiture e Codici

Melamine Cabinets / Mobili in Melaminico

cod. **WRKML1S.00-00/PK__**

Melamine Laquered Cabinets / Mobili in Melaminico Laccato

cod. **WRKQL1S.__-00/PK__**

DKK - kr

20.195

25.295

WORKSTATION 2027 DX L-VERSION 240



Workstation with 2027 structure, cabinet consisting of module with sliding doors and lock, 1 partition and 1 shelf per compartment, open module with 1 shelf. Wraparound work desktop white colour, thickness 22mm.

Stazione di lavoro con struttura 2027, mobile composto da modulo con ante scorrevoli e serratura, 1 tramezza e 1 ripiano per vano, modulo a giorno con 1 ripiano. Piano scrivania di lavoro avvolgente di colore bianco, spessore 22mm.

Melamine Laquered Cabinets Colors
Colori Laccati Mobili Melaminico

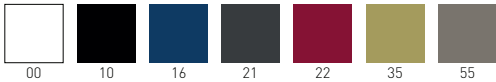

Frame colors
Colori struttura



Melamine Cabinets Color
Colore Mobili Melaminico



Laminated top color
Colori piano laminato

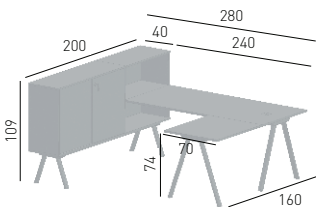

Unassembled structure, individual modules assembled.
Struttura non assemblata, singoli moduli assemblati.



1,17 m³
139,5 kg.

Finishing & Codes / Finiture e Codici

Melamine Cabinets / Mobili in Melaminico

cod. **WRKML2D.00-00/PK__**

Melamine Laquered Cabinets / Mobili in Melaminico Laccato

cod. **WRKQL2D.__-00/PK__**

DKK - kr

21.595

28.795

WORKSTATION 2027 SX L-VERSION 240



Workstation with 2027 structure, cabinet consisting of module with sliding doors and lock, 1 partition and 1 shelf per compartment, open module with 1 shelf. Wraparound work desktop white colour, thickness 22mm.

Stazione di lavoro con struttura 2027, mobile composto da modulo con ante scorrevoli e serratura, 1 tramezza e 1 ripiano per vano, modulo a giorno con 1 ripiano. Piano scrivania di lavoro avvolgente di colore bianco, spessore 22mm.

Melamine Laquered Cabinets Colors
Colori Laccati Mobili Melaminico



Frame colors
Colori struttura



Melamine Cabinets Color
Colore Mobili Melaminico



Laminated top color
Colori piano laminato

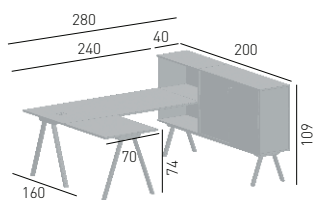

Unassembled structure, individual modules assembled.
Struttura non assemblata, singoli moduli assemblati.



1,17 m³
139,5 kg.

Finishing & Codes / Finiture e Codici

Melamine Cabinets / Mobili in Melaminico

cod. **WRKML2S.00-00/PK__**

Melamine Laquered Cabinets / Mobili in Melaminico Laccato

cod. **WRKQL2S.__-00/PK__**

DKK - kr

21.595

28.795

WORKSTATION 2027 DX VERSION 180 WITH BENCH



Workstation with 2027 structure, cabinet consisting of module with sliding doors and lock, 1 partition and 1 shelf per compartment, open module with 1 shelf. Straight desktop white colour, thickness 22mm. Bench module with padded and upholstered seats.

Stazione di lavoro con struttura 2027, mobile composto da modulo con ante scorrevoli e serratura, 1 tramezza e 1 ripiano per vano, modulo a giorno con 1 ripiano. Piano scrivania di lavoro diritta di colore bianco, spessore 22mm. Modulo panca con sedute imbottite e tappezzate.

BENCH module available coverings / Finiture disponibili modulo panca
 King fabric / Tessuto King **K**
 Aurea eco-leather / Ecopelle Aurea **E**
 Blazer fabric / Tessuto Blazer **B**
 Leather / Pelle **P**
 Kvadrat fabrics / Tessuti Kvadrat **DK**

Melamine Laquered Cabinets Colors
Colori Laccati Mobili Melaminico



Frame colors
Colori struttura

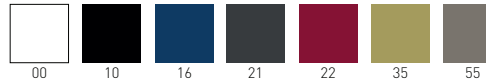

Melamine Cabinets Color
Colore Mobili Melaminico



Laminated top color
Colori piano laminato

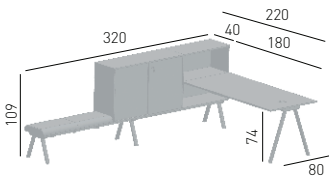

Unassembled structure, individual modules assembled.
Struttura non assemblata, singoli moduli assemblati.



1,14 m³
122,1 kg.

Finishing & Codes / Finiture e Codici

Melamine Cabinets / Mobili in Melaminico

cod. WRKMD1DP.00-00-_(K)/PK__

cod. WRKMD1DP.00-00-_(E)/PK__

cod. WRKMD1DP.00-00-_(B)/PK__

cod. WRKMD1DP.00-00-_(P)/PK__

cod. WRKMD1DP.00-00-_(DK)/PK__

Melamine Laquered Cabinets / Mobili in Melaminico Laccato

cod. WRKQD1DP. __-00-_(K)/PK__

cod. WRKQD1DP. __-00-_(E)/PK__

cod. WRKQD1DP. __-00-_(B)/PK__

cod. WRKQD1DP. __-00-_(P)/PK__

cod. WRKQD1DP. __-00-_(DK)/PK__

DKK - kr

21.695

21.695

22.295

23.995

23.995

27.095

27.095

27.595

28.195

28.195

WORKSTATION 2027 SX VERSION 180 WITH BENCH



Workstation with 2027 structure, cabinet consisting of module with sliding doors and lock, 1 partition and 1 shelf per compartment, open module with 1 shelf. Straight desktop white colour, thickness 22mm. Bench module with padded and upholstered seats.

Stazione di lavoro con struttura 2027, mobile composto da modulo con ante scorrevoli e serratura, 1 tramezza e 1 ripiano per vano, modulo a giorno con 1 ripiano. Piano scrivania di lavoro diritta di colore bianco, spessore 22mm. Modulo panca con sedute imbottite e tappezzate.

BENCH module available coverings / Finiture disponibili modulo panca
 King fabric / Tessuto King **K**
 Aurea eco-leather / Ecopelle Aurea **E**
 Blazer fabric / Tessuto Blazer **B**
 Leather / Pelle **P**
 Kvadrat fabrics / Tessuti Kvadrat **DK**

Melamine Laquered Cabinets Colors
Colori Laccati Mobili Melaminico



Frame colors
Colori struttura

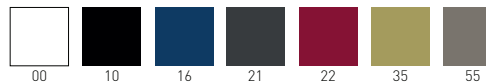

Melamine Cabinets Color
Colore Mobili Melaminico



Laminated top color
Colori piano laminato

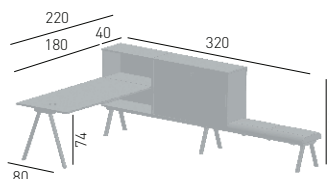

Unassembled structure, individual modules assembled.
Struttura non assemblata, singoli moduli assemblati.



1,14 m³
122,1 kg.

Finishing & Codes / Finiture e Codici

Melamine Cabinets / Mobili in Melaminico

cod. WRKMD1SP.00-00-_(K)/PK__

cod. WRKMD1SP.00-00-_(E)/PK__

cod. WRKMD1SP.00-00-_(B)/PK__

cod. WRKMD1SP.00-00-_(P)/PK__

cod. WRKMD1SP.00-00-_(DK)/PK__

Melamine Laquered Cabinets / Mobili in Melaminico Laccato

cod. WRKQD1SP. __-00-_(K)/PK__

cod. WRKQD1SP. __-00-_(E)/PK__

cod. WRKQD1SP. __-00-_(B)/PK__

cod. WRKQD1SP. __-00-_(P)/PK__

cod. WRKQD1SP. __-00-_(DK)/PK__

DKK - kr

21.695

21.695

22.295

23.995

23.995

26.995

26.995

27.595

28.195

28.195

WORKSTATION 2027 DX VERSION 240 WITH BENCH



Workstation with 2027 structure, cabinet consisting of module with sliding doors and lock, 1 partition and 1 shelf per compartment, open module with 1 shelf. Straight desktop white colour, thickness 22mm. Bench module with padded and upholstered seats.

Stazione di lavoro con struttura 2027, mobile composto da modulo con ante scorrevoli e serratura, 1 tramezza e 1 ripiano per vano, modulo a giorno con 1 ripiano. Piano scrivania di lavoro dritta di colore bianco, spessore 22mm. Modulo panca con sedute imbottite e tappezzate.

BENCH module available coverings / Finiture disponibili modulo panca
 King fabric / Tessuto King **K**
 Aurea eco-leather / Ecopelle Aurea **E**
 Blazer fabric / Tessuto Blazer **B**
 Leather / Pelle **P**
 Kvadrat fabrics / Tessuti Kvadrat **DK**

Melamine Laquered Cabinets Colors
 Colori Laccati Mobili Melaminico

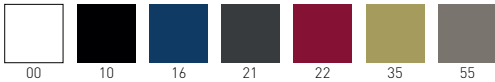

Frame colors
 Colori struttura

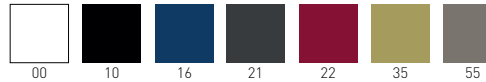

Melamine Cabinets Color
 Colore Mobili Melaminico



Laminated top color
 Colori piano laminato

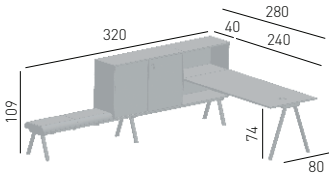

Unassembled structure, individual modules assembled.
 Struttura non assemblata, singoli moduli assemblati.



1,14 m³
 132,1 kg.

Finishing & Codes / Finiture e Codici

Melamine Cabinets / Mobili in Melaminico

cod. WRKMD2DP.00-00-_(K)/PK__

cod. WRKMD2DP.00-00-_(E)/PK__

cod. WRKMD2DP.00-00-_(B)/PK__

cod. WRKMD2DP.00-00-_(P)/PK__

cod. WRKMD2DP.00-00-_(DK)/PK__

Melamine Laquered Cabinets / Mobili in Melaminico Laccato

cod. WRKQD2DP.__-00-_(K)/PK__

cod. WRKQD2DP.__-00-_(E)/PK__

cod. WRKQD2DP.__-00-_(B)/PK__

cod. WRKQD2DP.__-00-_(P)/PK__

cod. WRKQD2DP.__-00-_(DK)/PK__

DKK - kr

23.195

23.195

23.795

24.395

24.395

28.495

28.495

29.095

29.695

29.695

WORKSTATION 2027 SX VERSION 240 WITH BENCH



Workstation with 2027 structure, cabinet consisting of module with sliding doors and lock, 1 partition and 1 shelf per compartment, open module with 1 shelf. Straight desktop white colour, thickness 22mm. Bench module with padded and upholstered seats.

Stazione di lavoro con struttura 2027, mobile composto da modulo con ante scorrevoli e serratura, 1 tramezza e 1 ripiano per vano, modulo a giorno con 1 ripiano. Piano scrivania di lavoro dritta di colore bianco, spessore 22mm. Modulo panca con sedute imbottite e tappezzate.

BENCH module available coverings / Finiture disponibili modulo panca
 King fabric / Tessuto King **K**
 Aurea eco-leather / Ecopelle Aurea **E**
 Blazer fabric / Tessuto Blazer **B**
 Leather / Pelle **P**
 Kvadrat fabrics / Tessuti Kvadrat **DK**

Melamine Laquered Cabinets Colors
 Colori Laccati Mobili Melaminico



Frame colors
 Colori struttura

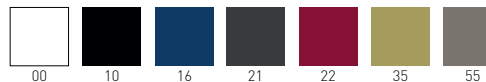

Melamine Cabinets Color
 Colore Mobili Melaminico



Laminated top color
 Colori piano laminato

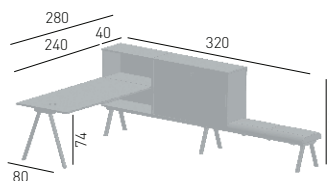

Unassembled structure, individual modules assembled.
 Struttura non assemblata, singoli moduli assemblati.



1,14 m³
 132,1 kg.

Finishing & Codes / Finiture e Codici

Melamine Cabinets / Mobili in Melaminico

cod. WRKMD2SP.00-00-_(K)/PK__

cod. WRKMD2SP.00-00-_(E)/PK__

cod. WRKMD2SP.00-00-_(B)/PK__

cod. WRKMD2SP.00-00-_(P)/PK__

cod. WRKMD2SP.00-00-_(DK)/PK__

Melamine Laquered Cabinets / Mobili in Melaminico Laccato

cod. WRKQD2SP.__-00-_(K)/PK__

cod. WRKQD2SP.__-00-_(E)/PK__

cod. WRKQD2SP.__-00-_(B)/PK__

cod. WRKQD2SP.__-00-_(P)/PK__

cod. WRKQD2SP.__-00-_(DK)/PK__

DKK - kr

23.195

23.195

23.795

24.395

24.395

28.495

28.495

29.095

29.695

29.695

WORKSTATION 2027 X VERSION 180



Double workstation with 2027 structure, 2 cabinets consisting of modules with sliding doors and lock, 1 partition and 1 shelf per compartment, 1 open module with 1 shelf. Straight desktop white colour, thickness 22mm.

Stazione di lavoro doppia con struttura 2027, 2 mobili composto da moduli con ante scorrevoli e serratura, 1 tramezza e 1 ripiano per vano, 1 modulo a giorno con 1 ripiano. Piani scrivania di lavoro diritti di colore bianco, spessore 22mm.

Melamine Laquered Cabinets Colors
Colori Laccati Mobili Melaminico



Frame colors
Colori struttura



Melamine Cabinets Color
Colore Mobili Melaminico



Laminated top color
Colori piano laminato

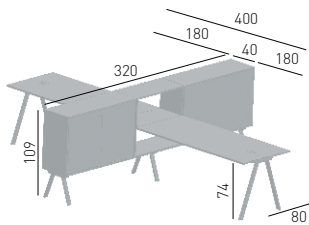

Unassembled structure, individual modules assembled.
Struttura non assemblata, singoli moduli assemblati.



1,75 m³
188,1 kg.

Finishing & Codes / Finiture e Codici

Melamine Cabinets / Mobili in Melaminico

cod. **WRKMX1.00-00/PK__**

Melamine Laquered Cabinets / Mobili in Melaminico Laccato

cod. **WRKQX1.__-00/PK__**

DKK - kr

30.895

39.195

WORKSTATION 2027 X VERSION 240



Double workstation with 2027 structure, 2 cabinets consisting of modules with sliding doors and lock, 1 partition and 1 shelf per compartment, 1 open module with 1 shelf. Straight desktop white colour, thickness 22mm.

Stazione di lavoro doppia con struttura 2027, 2 mobili composto da moduli con ante scorrevoli e serratura, 1 tramezza e 1 ripiano per vano, 1 modulo a giorno con 1 ripiano. Piani scrivania di lavoro diritti di colore bianco, spessore 22mm.

Melamine Laquered Cabinets Colors
Colori Laccati Mobili Melaminico



Frame colors
Colori struttura



Melamine Cabinets Color
Colore Mobili Melaminico



Laminated top color
Colori piano laminato

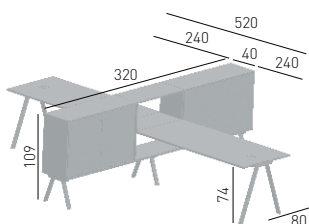

Unassembled structure, individual modules assembled.
Struttura non assemblata, singoli moduli assemblati.



1,79 m³
208,1 kg.

Finishing & Codes / Finiture e Codici

Melamine Cabinets / Mobili in Melaminico

cod. **WRKMX2.00-00/PK__**

Melamine Laquered Cabinets / Mobili in Melaminico Laccato

cod. **WRKQX2.__-00/PK__**

DKK - kr

34.095

43.095

Cabinets



To store files and folders in a world of colours. These filing cabinets are suspended, on frames, for easy obstruction-free cleaning. The cabinets themselves, tough and resistant, come with quick and effective assembly fixings. Drawers: On castors and fitted, these simple pieces help keep workspaces tidy and stationery in place.

Per contenere, archiviare e classificare, in un mondo a colori. I mobili contenitori sono sospesi, su strutture a cavalletto, per una semplice pulizia anche automatica. Le strutture, solide e resistenti, sono provviste di sistemi di assemblaggio veloci e sicuri.

Cassettiere: Su ruote e attrezzate, questi semplici complementi aiutano a contenere e ordinare le piccole necessità dell'ufficio.

Finishings / Finiture

Melamine Laquered Cabinets Colors
(Antibacterial water-base laquering)
Colori Laccati Mobili Melaminico
(Laccatura antibatterica a base acqua)

Frame colors
Colori struttura

Melamine Cabinets Color
Colore Mobili Melaminico

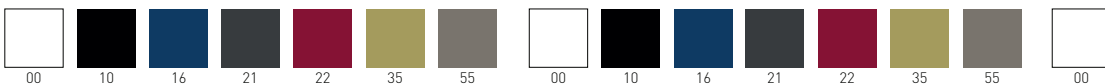

White Matte Laquered Neve (00) / Black Matte Laquered (10) / Blue Matte Laquered 5003 (16) / Grey Matte Laquered Antracite (21) / Bordeaux Matte Laquered 3004 (22) / Lime Matte Laquered Limone (35) / Mineral Grey Matte Laquered 7006 (55)

LOW CABINET 2027



Cabinet consisting of 2027 structure, 1 module with sliding doors and lock, 1 partition and 1 shelf per compartment, module with 2 filing cabinets. On request it is possible to replace the module with two filing cabinets with two drawers module. Maximum load on each sliding filing cabinet Kg. 20.

Mobile composto da struttura 2027, modulo con ante scorrevoli e serratura, 1 tramezza e 1 ripiano per vano, modulo con 2 classificatori. Su richiesta, è possibile sostituire il modulo a due classificatori con il modulo a due cassetti estraibili. Carico massimo su ogni classificatore estraibile Kg.20.

Melamine Laquered Cabinets Colors Colori Laccati Mobili Melaminico

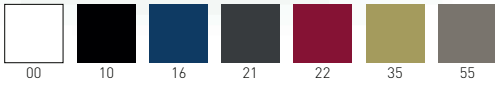

Frame colors Colori struttura

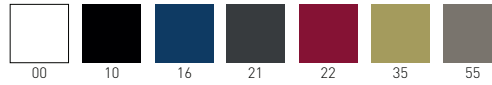

Melamine Cabinets Color Colore Mobili Melaminico

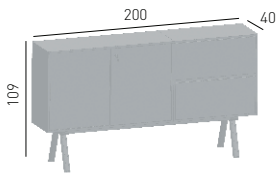

Unassembled structure, individual modules assembled.
Struttura non assemblata, singoli moduli assemblati.



0,84 m³
96,4 kg.

Finishing & Codes / Finiture e Codici

Melamine Cabinets / Mobili in Melaminico

cod. **CABMLC.00/PK__**

Melamine Laquered Cabinets / Mobili in Melaminico Laccato

cod. **CABQLC.__/PK__**

DKK - kr

17.095

22.895

CABINET 2027



Cabinet consisting of 2027 structure and module with sliding doors and lock, 1 Partition and 2 shelves per compartment.

Mobile composto da struttura 2027 e modulo con ante scorrevoli e serratura, 1 tramezza e 2 ripiani per vano.

Melamine Laquered Cabinets Colors Colori Laccati Mobili Melaminico



Frame colors Colori struttura



Melamine Cabinets Color Colore Mobili Melaminico

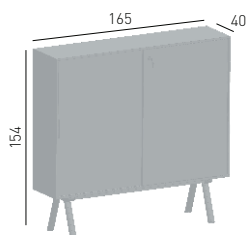

Unassembled structure, individual modules assembled.
Struttura non assemblata, singoli moduli assemblati.



1,03 m³
87,9 kg.

Finishing & Codes / Finiture e Codici

Melamine Cabinets / Mobili in Melaminico

cod. **CABMCC.00/PK__**

Melamine Laquered Cabinets / Mobili in Melaminico Laccato

cod. **CABQCC.__/PK__**

DKK - kr

14.195

21.595

MULTIPLE CABINET 2027



Cabinet consisting of 2027 structure and two modules with sliding doors and lock, 1 Partition and 2 shelves per compartment.
Mobile composto da struttura 2027 e 2 moduli con ante scorrevoli e serratura, 1 tramezza e 2 ripiani per vano.

Melamine Laquered Cabinets Colors
Colori Laccati Mobili Melaminico

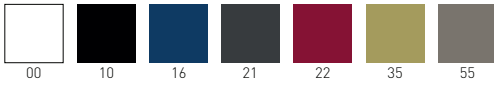

Frame colors
Colori struttura



Melamine Cabinets Color
Colore Mobili Melaminico

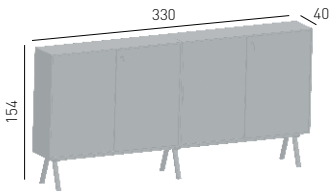

Unassembled structure, individual modules assembled.
Struttura non assemblata, singoli moduli assemblati.



2,01 m³
163,9 kg.

Finishing & Codes / Finiture e Codici

Melamine Cabinets / Mobili in Melaminico

cod. CABMMC.00/PK__

Melamine Laquered Cabinets / Mobili in Melaminico Laccato

cod. CABQMC.__/PK__

DKK - kr

28.095

42.895

HIGH CABINET 2027



Cabinet consisting of 2027 structure, two modules with sliding doors and locks, 1 partition and 1 shelf per compartment, module with 2 filing cabinets, open module with 1 shelf. On request it is possible to replace the module with two filing cabinets with two drawers module. Maximum load on each sliding filing cabinet Kg. 20.

Mobile composto da struttura 2027, due moduli con ante scorrevoli e serrature, 1 tramezza e 1 ripiano per vano, modulo con 2 classificatori, modulo a giorno con 1 ripiano. Su richiesta, è possibile sostituire il modulo a due classificatori con il modulo a due cassetti estraibili. Carico massimo su ogni classificatore estraibile Kg.20.

Melamine Laquered Cabinets Colors
Colori Laccati Mobili Melaminico



Frame colors
Colori struttura



Melamine Cabinets Color
Colore Mobili Melaminico

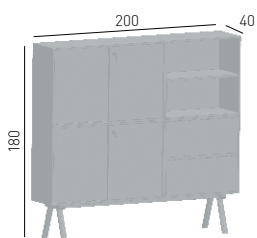

Unassembled structure, individual modules assembled.
Struttura non assemblata, singoli moduli assemblati.



1,54 m³
161,4 kg.

Finishing & Codes / Finiture e Codici

Melamine Cabinets / Mobili in Melaminico

cod. CABMHC.00/PK__

Melamine Laquered Cabinets / Mobili in Melaminico Laccato

cod. CABQHC.__/PK__

DKK - kr

27.695

39.295

LOW CABINET 2027 + SEATER



Cabinet consisting of 2027 structure, 1 module with sliding doors and lock, 1 partition and 1 shelf per compartment, upholstered service seats.

Mobile composto da struttura 2027, modulo con ante scorrevoli e serratura, 1 tramezza e 1 ripiano per vano, sedute imbottite di servizio.

BENCH module available coverings / Finiture disponibili modulo panca

King fabric / Tessuto King **K**

Aurea eco-leather / Ecopelle Aurea **E**

Blazer fabric / Tessuto Blazer **B**

Leather / Pelle **P**

Kvadrat fabrics / Tessuti Kvadrat **DK**

Melamine Laquered Cabinets Colors Colori Laccati Mobili Melaminico



Frame colors Colori struttura

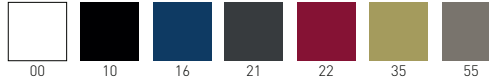

Melamine Cabinets Color Colore Mobili Melaminico

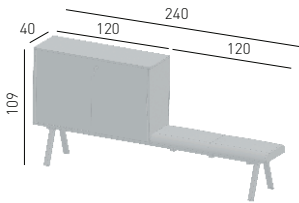

Unassembled structure, individual modules assembled.
Struttura non assemblata, singoli moduli assemblati.



0,55 m³
61,90 kg.

Finishing & Codes / Finiture e Codici

Melamine Cabinets / Mobili in Melaminico

cod. CABMLP.00-_(K)___/PK__

cod. CABMLP.00-_(E)___/PK__

cod. CABMLP.00-_(B)___/PK__

cod. CABMLP.00-_(P)___/PK__

cod. CABMLP.00-_(DK)___/PK__

Melamine Laquered Cabinets / Mobili in Melaminico Laccato

cod. CABQLP._____(K)___/PK__

cod. CABQLP._____(E)___/PK__

cod. CABQLP._____(B)___/PK__

cod. CABQLP._____(P)___/PK__

cod. CABQLP._____(DK)___/PK__

DKK - kr

12.995

12.995

13.595

14.095

14.095

16.295

16.295

16.895

17.395

17.395

DRAWER

Drawer on rubber wheels with lock. 3 drawers plus office product bin.
Cassettiera su ruote gommata con serratura. 3 cassetti più portacancelleria.



Melamine Laquered Drawer Colors
Colori Laccati Cassettiera Melaminico

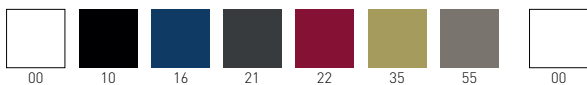

Melamine Drawer Color
Colore Cassettiera Melaminico

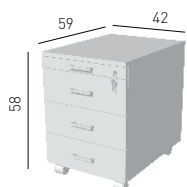

A assembled / assemblata



0,16 m³
28 kg.

Finishing & Codes / Finiture e Codici

Melamine Cabinets / Mobili in Melaminico

cod. **CABMDR.00/A**

Melamine Laquered Cabinets / Mobili in Melaminico Laccato

cod. **CABQDR.__/A**

DKK - kr

3.895

5.795



Display wall or floor fixed storage shelving can enhance your most ambitious projects. Available with a black, gold or white matt painted steel frame, without any visible welds, Display is set off with solid Fenix laminate shelves. Display is a modular piece, which can support up to 4 shelves and lends itself to completing and finely decorating walls and corners of your commercial spaces. For correct use, the structure must be fixed to the wall or floor.

Semplice ed elegante, Display decorerà con discrezione i vostri progetti più ambiziosi. Disponibile con struttura in acciaio verniciato nero, oro o bianco opaco, senza nessuna saldatura a vista, è impreziosito da solidi ripiani in laminato Fenix. Display è un elemento modulare, che può sostenere sino a 4 mensole e si presta a completare e decorare con raffinatezza pareti ed angoli dei vostri spazi commerciali. Per un corretto utilizzo, questo mobile deve essere fissato alla parete o pavimento.

Finishings / Finiture

Frame colors / Colori struttura



Fenix laminated top color / Colori piano laminato Fenix

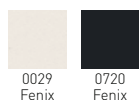

DISPLAY



Frame colors / Colori struttura

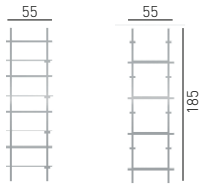
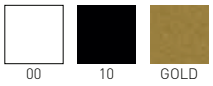

Single metal frame "Display", matt painted.
Struttura singola in metallo verniciato opaco "Display"

NA not assembled / non assemblato



0,63 m³ - 22 kg.
55x55x185cm.
1 pcs [carton]

Frame Finishing & Codes / Finiture Telai e Codici

cod. ACCV020.__

DKK - kr

8.095

Fenix laminated top color / Colori piano laminato Fenix

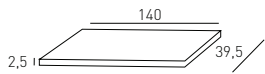
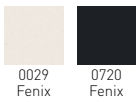

Laminated shelve "Display".
Mensola in laminato "Display"

NA not assembled / non assemblato



0,16 m³ - 9,50 kg.
1 pcs [carton]

Frame Finishing & Codes / Finiture Telai e Codici

Cod. PTL460.__ lam.fenix

DKK - kr

2.595

DISPLAY EXAMPLE OF USE



ACOUSTIC Collection



Collection certified UNI EN ISO 354:2003, sound absorption A Class following UNI EN ISO 11654:1998. The Collection is certified ASTM E84-16 for surface burning characteristics of building materials (UL723, UBC 8-1, NFPA 255). The collection is certified Class 1 Reaction to Fire following UNI 8457:1987-UNI 8457/A1:1996 and UNI 9174:1987-UNI 9174/A1:1996.
 Collezione certificata UNI EN ISO 354:2003, Classe A di assorbimento acustico secondo la norma UNI EN ISO 11654: 1998. La collezione è certificata ASTM E84-16 secondo le caratteristiche di resistenza al fuoco dei materiali da costruzione (UL723, UBC 8-1, NFPA 255). La collezione è certificata Classe 1 seguendo le norme UNI 8457:1987-UNI 8457/A1:1996 and UNI 9174:1987-UNI 9174/A1:1996 per la resistenza al fuoco.

Standard colors
 Colori standard



On demand, minimum 52 pcs - surcharge **DKK 250** each unit

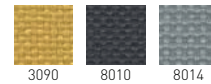

STILLY FLAT

Sound-absorbing system.
 Sistema di pannelli fonoassorbenti.

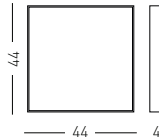

0,040 m³ - 2,95 kg.
 47x45x19cm.
 4 pcs [carton]

Finishing & Codes / Finiture e Codici

cod.PASTF.--
cod.PASTFB.-- led version

DKK - kr

425
1.395

**STILLY
 PYRAMID**

Sound-absorbing system.
 Sistema di pannelli fonoassorbenti.

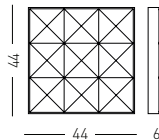

0,040 m³ - 2,95 kg.
 47x45x19cm.
 4 pcs [carton]

Finishing & Codes / Finiture e Codici

cod.PASTP.--
cod.PASTPB.-- led version

DKK - kr

425
1.395

Fono



Standard colors
Colori standard

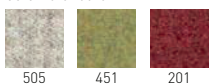

FONO A

Sound-absorbing system.
Sistema di pannelli fonoassorbenti.

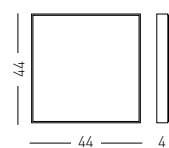

0,040 m³ - 2,95 kg.
47x45x19cm.
4 pcs [carton]

Finishing & Codes / Finiture e Codici

cod.PAFOA.--

DKK - kr

495

FONO B

Sound-absorbing system.
Sistema di pannelli fonoassorbenti.

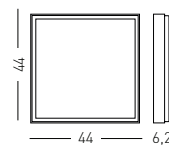

0,055 m³ - 3,20 kg.
47x45x26cm.
4 pcs [carton]

Finishing & Codes / Finiture e Codici

cod.PAFOB.--

DKK - kr

495

FONO C

Sound-absorbing system.
Sistema di pannelli fonoassorbenti.

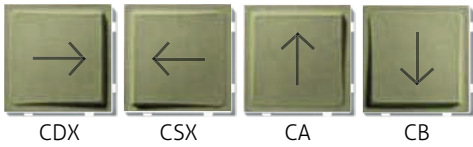

CDX

CSX

CA

CB

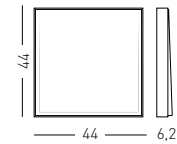

0,047 m³ - 3,10 kg.
47x45x22cm.
4 pcs [carton]

Finishing & Codes / Finiture e Codici

cod.PAFOCA.--
cod.PAFOCB.--
cod.PAFOCDX.--
cod.PAFOCSX.--

DKK - kr

495
495
495
495

FONO D

Sound-absorbing system.
Sistema di pannelli fonoassorbenti.



DDX

DSX

DA

DB

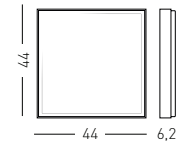

0,047 m³ - 3,10 kg.
47x45x22cm.
4 pcs [carton]

Finishing & Codes / Finiture e Codici

cod.PAFODA.--
cod.PAFODB.--
cod.PAFODDX.--
cod.PAFODSX.--

DKK - kr

495
495
495
495



Uniko

Collection certified UNI EN ISO 354:2003, sound absorption C Class following UNI EN ISO 11654:1998.
 Collezione certificata UNI EN ISO 354:2003, Classe C di assorbimento acustico secondo la norma UNI EN ISO 11654: 1998.

UNIKO FLAT



Sound-absorbing system for false ceiling.
 Sistema di pannelli fonoassorbenti per controsoffitti.

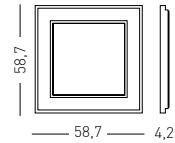

Finishing & Codes / Finiture e Codici

cod.PAUKF.--

DKK - kr

575

Standard colors / Colori standard

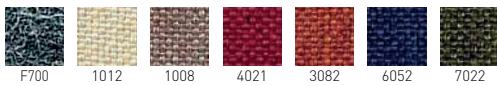

0,060 m³ - 3,7 kg.
 61x61x16cm.
 3 pcs [carton]

UNIKO PIRAMID



Sound-absorbing system for false ceiling.
 Sistema di pannelli fonoassorbenti per controsoffitti.

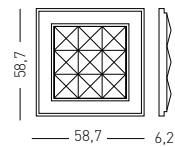

Finishing & Codes / Finiture e Codici

cod.PAUKP.--

DKK - kr

575

Standard colors / Colori standard



0,060 m³ - 3,7 kg.
 61x61x16cm.
 3 pcs [carton]

UNIKO 4



Sound-absorbing system for false ceiling.
 Sistema di pannelli fonoassorbenti per controsoffitti.

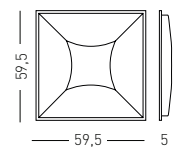

Finishing & Codes / Finiture e Codici

cod.PAUK4.-- Uniko 4 Coverings

DKK - kr

475

Uniko 4 coverings colors / Uniko 4 colori tessuti

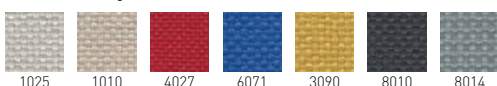

0,060 m³ - 6,4 kg.
 61x61x16cm.
 10 pcs [carton]

Madison



Madison 4 coverings colors / Madison 4 colori tessuti

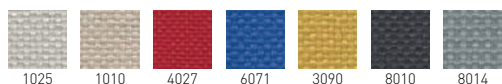

1025 1010 4027 6071 3090 8010 8014

MADISON 4



Sound-absorbing system for false ceiling.
Sistema di pannelli fonoassorbenti per controsoffitti.

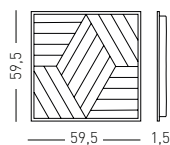

0,060 m³ - 6,5 kg.
61x61x16cm.
10 pcs [carton]

Finishing & Codes / Finiture e Codici

cod.PAMA4.-- Madison 4 Coverings

DKK - kr

495

Diamante

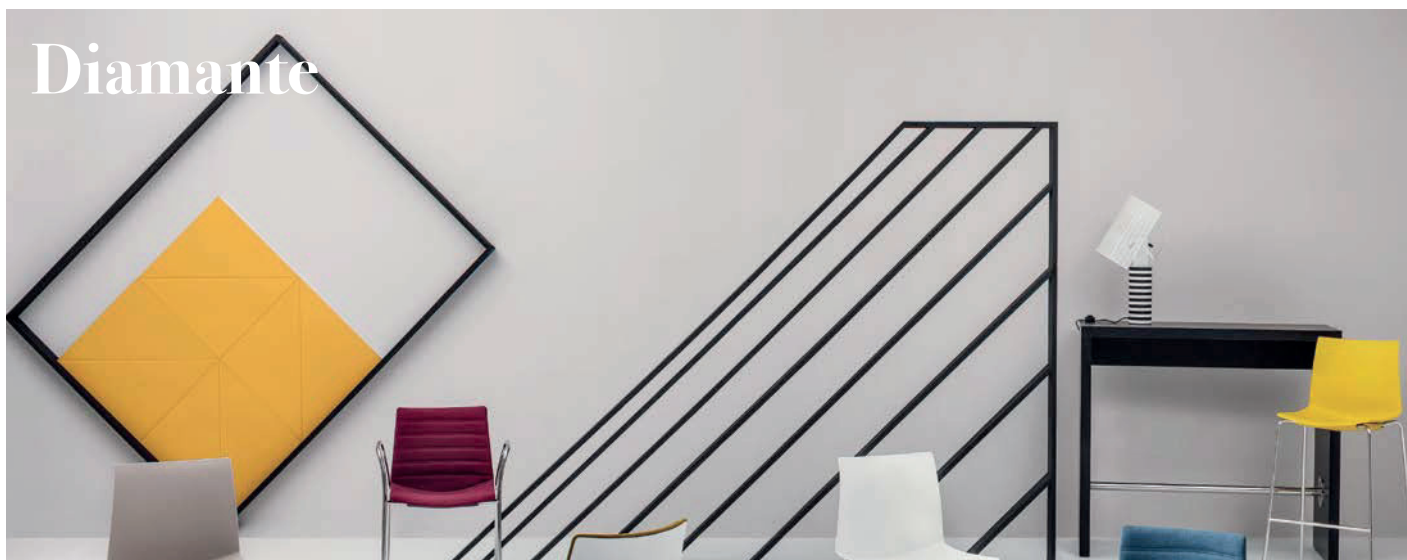

Collection certified UNI EN ISO 354:2003, sound absorption A Class following UNI EN ISO 11654:1998.
 Collezione certificata UNI EN ISO 354:2003, Classe A di assorbimento acustico secondo la norma UNI EN ISO 11654: 1998.

Diamante 4 / Diamante Double 4 / Diamante Spotlight X2 / X4 Coverings

Frame colors

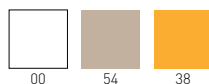

DIAMANTE 4

Diamond sound-absorbing panels.
 Pannelli fonoassorbenti Diamante.

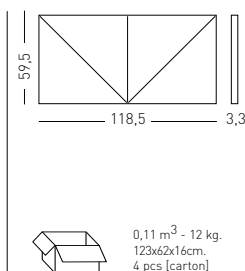

Finishing & Codes / Finiture e Codici

cod.PADI4.>-- Diamante 4 Coverings

Diamante 4 customized printed panel
 Pannello Diamante 4 personalizzato stampato
 (min 4pcs)

DKK - kr

1.225
3.695

DIAMANTE DOUBLE 4

Diamond sound-absorbing panels
 with double coverings.
 Pannelli fonoassorbenti Diamante con
 doppia copertura.

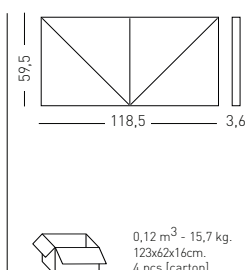

Finishing & Codes / Finiture e Codici

cod.PADI4D.-- Diamante Double 4 Coverings

Diamante 4 Double customized printed panel
 Pannello Diamante 4 Double personalizzato
 stampato (min 4pcs)

DKK - kr

1.695
4.195

DIAMANTE SPOTLIGHT X2

Sound-absorbing panel with
 integrated lighting kit (2 led).
 Pannello fonoassorbente con kit
 illuminazione integrato (2 led).



Only with ACCV005 horizontal
 suspension kit.
 Solo con ACCV005 kit sospensione
 orizzontale.

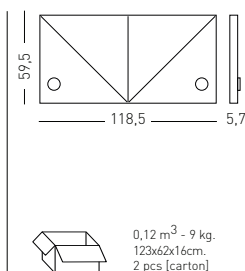

Finishing & Codes / Finiture e Codici

cod.PADLX2.--

DKK - kr

1.895

DIAMANTE SPOTLIGHT X4



Sound-absorbing panel with integrated lighting kit (4 led).
Pannello fonoassorbente con kit illuminazione integrato (4 led).

Only with ACCV005 horizontal suspension kit.
Solo con ACCV005 kit sospensione orizzontale.

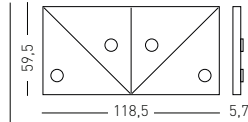

0,12 m³ - 9 kg.
123x62x16cm.
2 pcs [carton]

Finishing & Codes / Finiture e Codici

cod.PADLX4.--

DKK - kr

2.595

DIAMANTE VERTICAL SUSPENSION

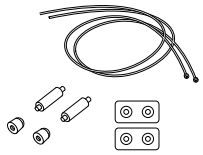

Vertical suspension optional kit, length 3m.
Kit opzionale sospensione verticale, lunghezza 3m.

Codes / Codici

ACCV004

DKK - kr

375

DIAMANTE HORIZONTAL SUSPENSION

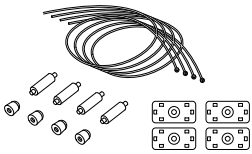

Horizontal suspension optional kit, length 3m.
Kit opzionale sospensione orizzontale, lunghezza 3m.

Codes / Codici

ACCV005

DKK - kr

895

DIAMANTE PEDESTAL

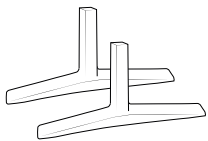

2 white legs pedestal optional kit.
Kit opzionale 2 gambe piedistallo bianche.

Codes / Codici

ACCV006.00 white/bianco

DKK - kr

250

DIAMANTE PARTITION LEG



Screen partition optional kit.
Kit opzionale divisorio.

Codes / Codici

ACCV007

DKK - kr

550

DIAMANTE WALL FIXING

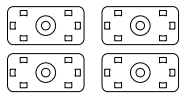

Wall fixing optional kit.
Kit opzionale fissaggio a parete.

Codes / Codici

ACCV008

DKK - kr

425

DIAMANTE LIGHTING SYSTEM

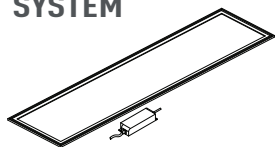

Horizontal suspension lighting system kit.
Kit di illuminazione per sospensione orizzontale.

Codes / Codici

ACCV009

DKK - kr

2.700



DIAMANTE PARTITION A

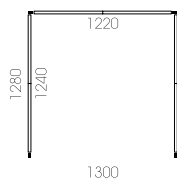

0,50 m³ - 32 kg.
1 pcs [carton]

Finishing & Codes / Finiture e Codici

cod.PAPADA.--

DKK - kr

13.595

DIAMANTE PARTITION B

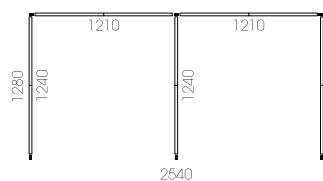

0,60 m³ - 52 kg.
1 pcs [carton]

Finishing & Codes / Finiture e Codici

cod.PAPADB.--

DKK - kr

21.495

DIAMANTE PARTITION C

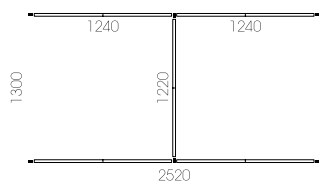

0,60 m³ - 52 kg.
1 pcs [carton]

Finishing & Codes / Finiture e Codici

cod.PAPADC.--

DKK - kr

21.495

DIAMANTE PARTITION D

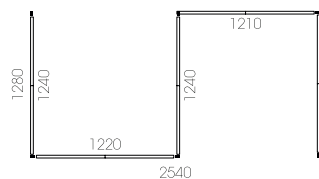

0,60 m³ - 52 kg.
1 pcs [carton]

Finishing & Codes / Finiture e Codici

cod.PAPADD.--

DKK - kr

21.495

DIAMANTE PARTITION E

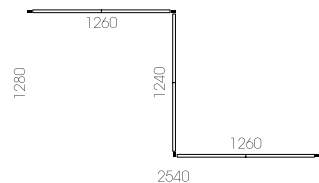

0,50 m³ - 32 kg.
1 pcs [carton]

Finishing & Codes / Finiture e Codici

cod.PAPADE.--

DKK - kr

13.595

DIAMANTE PARTITION F

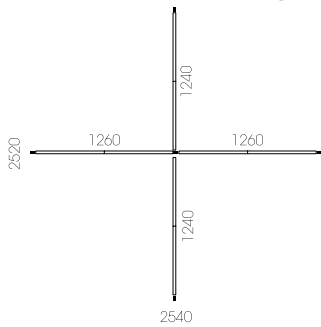

0,50 m³ - 44 kg.
1 pcs [carton]

Finishing & Codes / Finiture e Codici

cod.PAPADF.--

DKK - kr

17.395

DIAMANTE PARTITION A2

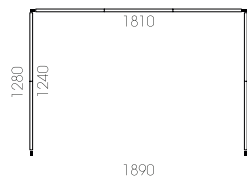

0,50 m³ - 36 kg.
1 pcs [carton]

Finishing & Codes / Finiture e Codici

cod.PAPADA2.--

DKK - kr

15.195

DIAMANTE PARTITION B2

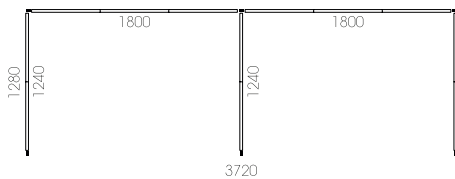

0,60 m³ - 60 kg.
1 pcs [carton]

Finishing & Codes / Finiture e Codici

cod.PAPADB2.--

DKK - kr

24.795

DIAMANTE PARTITION C2

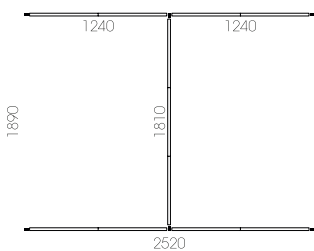

0,60 m³ - 56 kg.
1 pcs [carton]

Finishing & Codes / Finiture e Codici

cod.PAPADC2.--

DKK - kr

23.195

DIAMANTE PARTITION D2

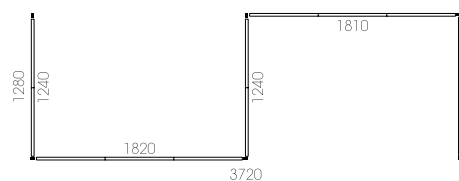

0,60 m³ - 60 kg.
1 pcs [carton]

Finishing & Codes / Finiture e Codici

cod.PAPADD2.--

DKK - kr

24.795

Piuma



Collection certified UNI EN ISO 354:2003, sound absorption A Class following UNI EN ISO 11654:1998.
 Collezione certificata UNI EN ISO 354:2003, Classe A di assorbimento acustico secondo la norma UNI EN ISO 11654: 1998.

Standard colors Colori standard

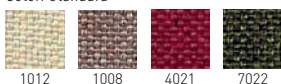

1012 1008 4021 7022

PIUMA 55

Sound-absorbing system.
Sistema di pannelli fonoassorbenti.

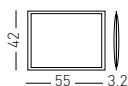

0,06 m³ - 4 kg.
45x80x16cm.
4 pcs [carton]

Finishing & Codes / Finiture e Codici

cod.PAPI55_

DKK - kr

24.795

PIUMA 65



Sound-absorbing system.
Sistema di pannelli fonoassorbenti.

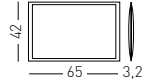

0,06 m³ - 5 kg.
45x80x16cm.
4 pcs [carton]

Finishing & Codes / Finiture e Codici

cod.PAPI65.____

DKK - kr

995

PIUMA 75



Sound-absorbing system.
Sistema di pannelli fonoassorbenti.

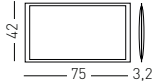

0,06 m³ - 6 kg.
45x80x16cm.
4 pcs [carton]

Finishing & Codes / Finiture e Codici

cod.PAPI75.____

DKK - kr

995

PIUMA 150



Sound-absorbing system.
Sistema di pannelli fonoassorbenti.

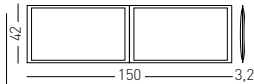

0,13 m³ - 12 kg.
45x80x35cm.
4 pcs [carton]

Finishing & Codes / Finiture e Codici

cod.PAPI150.____

DKK - kr

1.995

PIUMA BRACKET



Piuma bracket support, adjustable till 64mm table thickness.
Staffa di fissaggio pannello Piuma, regolabile sino ad uno spessore tavolo di 64mm.



Included on Piuma panels packaging.
Inclusa nell'imballo pannelli Piuma.

Finishing & Codes / Finiture e Codici

cod.ACCV016.00 white/bianco

DKK - kr

395

TUNE Free-Standing



The sound-absorbing free-standing panels of the Tune collection are designed both to furnish with elegance as well as to assure the precise function of reducing sound reverberation. Equipped with a matt painted metal base, they are made of polyester fiber and available in two different sizes.

I pannelli fonoassorbenti free-standing della famiglia Tune sono pensati per arredare con eleganza, nella precisa funzione di ridurre il riverbero sonoro. Dotati di basamento in metallo verniciato opaco, sono realizzati in fibra di poliestere e disponibili in due diverse dimensioni.

Finishings / Finiture

Frame colors / Colori struttura

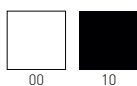

Standard colors / Colori standard

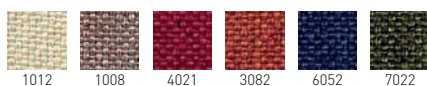

TUNE FREE-STANDING 80



Frame colors / Colori struttura

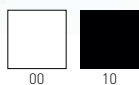

Standard colors / Colori standard

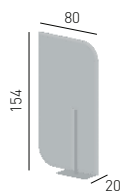
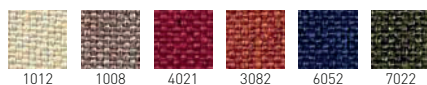

NA not assembled / non assemblato



0,125 m³ - 15,5 kg.
159x110x7cm.
1 pcs [carton]

Frame Finishing & Codes / Finiture Telai e Codici

cod. PATNS80_(FRAME)_-(FABRIC)_

DKK - kr

4.895

TUNE FREE-STANDING 100



Frame colors / Colori struttura

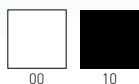

Standard colors / Colori standard

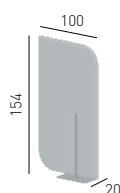
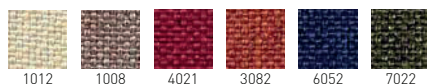

NA not assembled / non assemblato



0,125 m³ - 16,5 kg.
159x110x7cm.
1 pcs [carton]

Frame Finishing & Codes / Finiture Telai e Codici

cod. PATNS100_(FRAME)_-(FABRIC)_

DKK - kr

4.995

"Tune" acoustic panel, with black or white matt painted metal frame.
Pannello Fonoassorbente "Tune", basamento in metallo verniciato nero o bianco opaco.

"Tune" acoustic panel, with black or white matt painted metal frame.
Pannello Fonoassorbente "Tune", basamento in metallo verniciato nero o bianco opaco.

TUNE Desk Settings



The sound-absorbing panels of the Tune collection fixed to the desk tops are practical screens to enhance privacy, improving acoustic comfort, facilitating concentration and well-being in the workplace.

I pannelli fonoassorbenti della famiglia Tune fissati ai piani delle scrivanie come pratici schermi per valorizzare la privacy, migliorano il comfort acustico, agevolando la concentrazione e il benessere nell'ambito degli ambienti di lavoro.

Finishings / Finiture

Bracket color / Colore staffa fissaggio



00

Standard colors / Colori standard



1012

1008

4021

3082

6052

7022

TUNE DESK SETTINGS 80



"Tune" acoustic panel, with white bracket kit for desk settings.
Pannello Fonoassorbente "Tune", con kit staffe fissaggio a scrivania colore bianco.

Bracket color / Colore staffa fissaggio



00

Standard colors / Colori standard



1012

1008

4021

3082

6052

7022

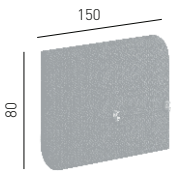

NA not assembled / non assemblato



0,125 m³ - 10 kg.
159x110x7cm.
1 pcs [carton]

Frame Finishing & Codes / Finiture Telai e Codici

cod. PATND80.00- _____

DKK - kr

3.995

Onda



Finishing Finiture



ONDA



Onda fills of persona-lity any environments, decorating and lighting them, even improving acoustic comfort.

Onda riempie di carattere gli ambienti, decorandoli, illuminandoli e fungendo anche da elemento fonoassorbente.

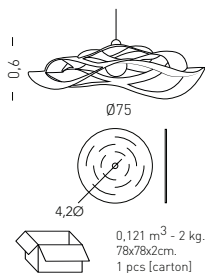

Finishing & Codes / Finiture e Codici

cod.LAON2.FB-F700
cod.LAON2.FB-F032
cod.LAON2.FB-F065

DKK - kr

1.995
1.995
1.995

ACCESSORIES

White Lamp Holder.
Portalampada Bianco.

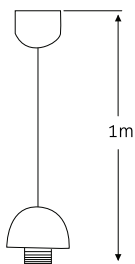

Finishing & Codes / Finiture e Codici

ACCV003

DKK - kr

225

Culture

Malene Flensted Urup Design



Ø50 or Ø70 cm aluminum planter, black painted, complete with suspension column, available in customize length between 100cm to 240cm.

Vaso in alluminio Ø50 o Ø70 cm, verniciato nero, completo di colonna di sospensione, disponibile in lunghezze personalizzate da 100cm a 240cm

Frame Color / Colore Struttura



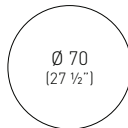
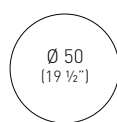
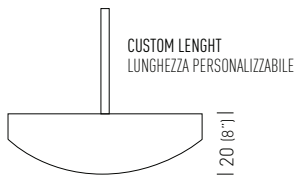

10



diam.50
diam.70

1500/NAN
1501/NAN

 0.20m³ / 10kg / 1pcs DKK - kr
 0.20m³ / 11kg / 1pcs

8.095
9.695



Flaire

Studio Eurolinea Design

Techno-polymer Lamp collection
with diffused shine effect.

Collezione di lampade in materiale
plastico con effetto a bagliore diffuso.

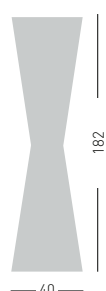

CE



230V – 50Hz
1 X 16W – Led Modul
IP 65

Colors / Colori



00

H182

2182/A



0.32m³ / 15kg / 1pcs

DKK - kr

7.695

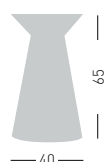

CE



230V – 50Hz
1 X 16W – Led Modul
IP 65

Colors / Colori



00

H65

2065/A



0.14m³ / 12kg / 1pcs

DKK - kr

3.995

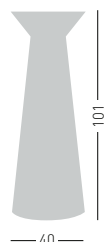

CE



230V – 50Hz
1 X 16W – Led Modul
IP 65

Colors / Colori



00

H101

2101/A



0.21m³ / 14kg / 1pcs

DKK - kr

5.295



Lux

Studio Eurolinea Design

Anodized aluminum
and techno-polymer coat-hanger.
Appendiabiti in alluminio
anodizzato e tecnopolimero

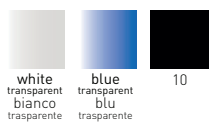

49.--



0.1m³ / 11kg / 1pcs

DKK - kr

1.495

ACCESSORIES ACCESSORI

CHAIR CONNECTIONS / GANCI PER UNIRE LE SEDIE

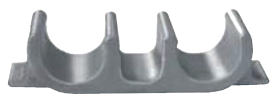

1000
for models Maya, Tulip and Iris
per modelli Maya, Tulip e Iris

DKK - kr

80



1002
for models with frame Ø 16mm
per modelli con telaio Ø 16mm

DKK - kr

80



1001
for model Compact
per modello Compact

DKK - kr

80



1005
for Models Kanvas ST
per modelli Kanvas ST

DKK - kr

80



All glides
tutti i tipi di tappi

DKK - kr

40

TABLE LINKING DEVICE / AGGANCIAMENTO PER TAVOLI



Cod. 1100
Metal-Technopolymer Linking device KIT (male+female), suitable for Laminated table tops (22 or 25 mm), complete with screws and pre-drilled holes on table-tops.
Not assembled.
KIT Aggancio in Metallo-Tecnopolimero (maschio+femmina), adatto a piani in Laminato (22 o 25 mm), completo di viti e pre-forature sui piani.
Non assemblato.

DKK - kr

695

1 Kit allow the complete connection between two tables.
1 Kit permette la connessione completa di due tavoli.

TABLET STAND / SUPPORTO TABLET

Technopolymer Tablet stand supports all top-selling tablets and smartphones in both portrait or landscape positions. The tablet stand fit perfectly all Compactop Surfaces, both 11 or 12 mm thick.

Accessorio in tecnopolimero per supportare i più venduti tablet o smartphones, sia in posizione verticale che orizzontale, è utilizzabile su superfici in Compactop, in entrambi gli spessori 11 e 12mm.

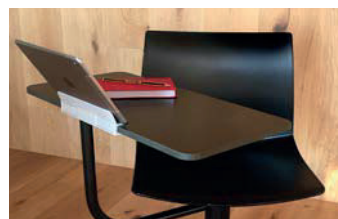

Available Color / Colori disponibili



G1



50
36

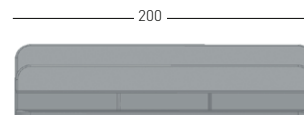

cod. 1103.G1 0.005m³ / 5kg / 50pcs DKK - kr

75

POWER UNIT / UNITÀ DI ELETRIFICAZIONE

The Power Unit includes a power socket (Schuko), a USB type A+C port and 2meter connection cable. Thanks to its stand-alone base, the power unit can fixed by screws or can be placed anywhere on the worktop without any limits, allowing the user to get the power wherever is needed. Thanks to a suspension bracket the power unit can be easily mounted upside-down the worksurface, in order to keep free your desk.

Il sistema di elettrificazione da scrivania include una presa energia (Schuko), le porte USB A+C. e due metri di cavo di connessione. La sua base d'appoggio consente di essere fissata con viti o posizionata senza alcun vincolo al piano, offrendo la libertà di utilizzo ovunque ci sia una esigenza di collegamento. Il fissaggio sotto piano per mezzo di un'apposita staffa permette di liberare le superfici d'appoggio, in questo modo si può sfruttare al massimo lo spazio della superficie di lavoro.



Available Color / Colori disponibili

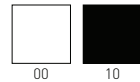

cod. ACCV040.00 white/bianco

cod. ACCV040.10 black/nero

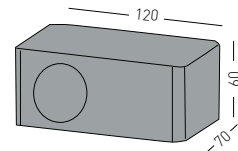

DKK - kr

0.06m³ / 7.5kg / 8pcs

0.06m³ / 7.5kg / 8pcs

2.095

2.095



GABER TOOL BOX

The technopolymer Gaber Tool Box is a practical desk organiser. The Tool Box stacks perfectly and is available in a wide range of trendy vibrant color.

Gaber Tool Box è un pratico raccogliitore di oggetti per la scrivania. Il Tool Box si impila perfettamente, ed è disponibile in una vasta gamma di moderni colori.

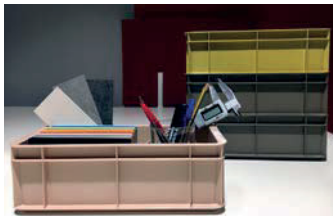

Available Color / Colori disponibili

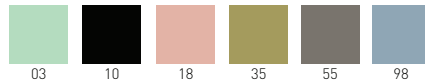

cod. ACCV011. __



0.015m³ / 0.6kg / 2pcs

150

GABER CLEANING KIT / KIT DI PULIZIA GABER

Excellent solution in order to keep the best cleaning on table tops, technopolymer chairs and stools, metal, aluminum and wooden surfaces.

Ottima soluzione per mantenere al meglio la pulizia dei piani tavoli, sedie e sgabelli in tecnopolimero, superfici in metallo, legno e alluminio.



DKK - kr

ACCV001

0.007m³ / 0.5kg / 1pcs

225

Cleanig liquid + Cloth / Detergente liquido + Panno

COLOURS AND COVERINGS

COLORI E RIVESTIMENTI

Techno-polymer / Tecnopolimero



Metal finishes / Finiture metalli

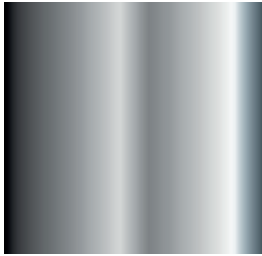

C
Chromed / Cromato



S
Satin / Satinato

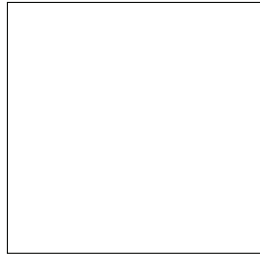

B
White / Bianco



N
Black / Nero



D
Gold / Oro



98
Pale blue / Avio



16
Indigo / Indaco



35
Lime / Lime



02
Yellow / Giallo



06
Red / Rosso



12
Brick / Mattone



22
Bordeaux / Bordeaux



54
Sand / Sabbia



18
Dusty Rose / Polvere Rosa



55
Mineral Gray / Grigio Minerale



14
Pearl Grey / Grigio Perla

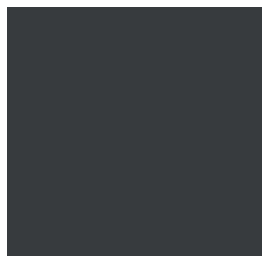

21
Grey / Grigio Antracite

COLOURS AND COVERINGS

COLORI E RIVESTIMENTI

Bases and frames wooden finishes / Finiture legno basi e telai



00 White stained / Bianco



F Natural Beech / Faggio naturale

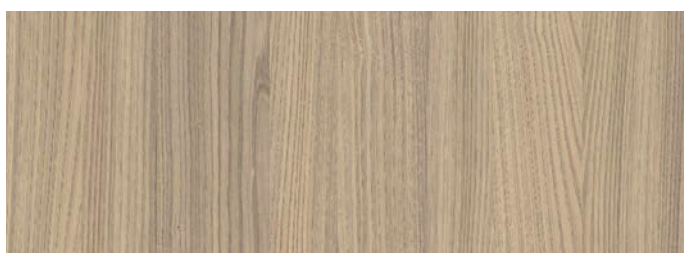

RN Natural Oak / Rovere Naturale



10 Black stained / Nero

F-00-10 finishes arise from Beech Essence. RN finish come from Oak Essence
Le finiture F-00-10 derivano da essenza di Faggio. La finitura RN deriva da essenza di Rovere.

Standard Compactop Surface

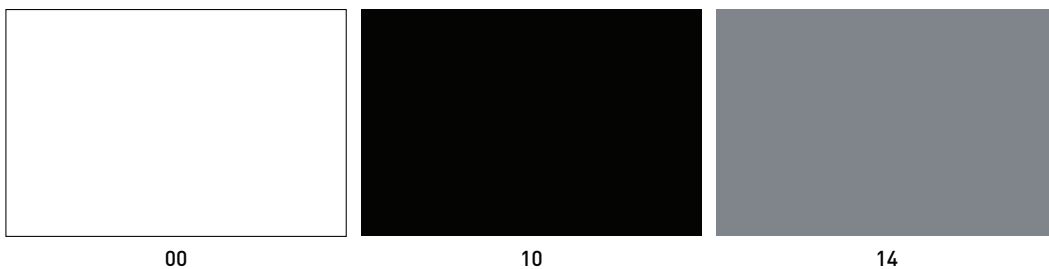

Special Compactop Surface Fenix - www.fenixforinteriors.com



Special Compactop Surface - Solid - www.arpaindustriale.com



Special Compactop Surface - Wood Effect - www.arpaindustriale.com

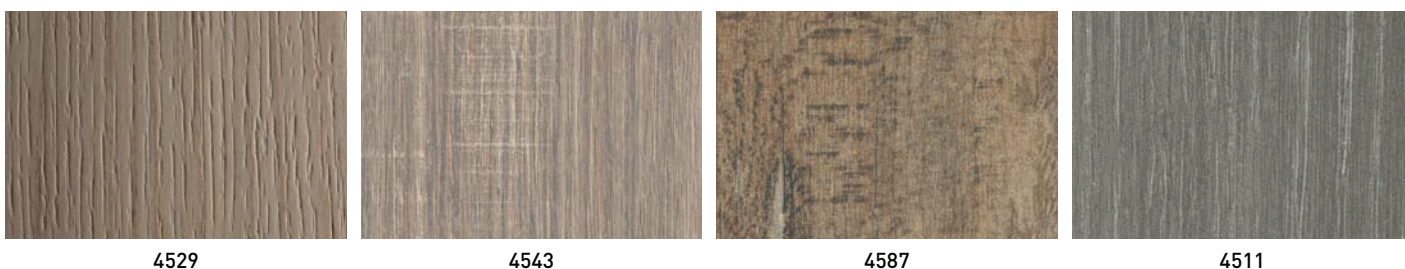

COLOURS AND COVERINGS

COLORI E RIVESTIMENTI

Special Compactop Surface - Stone, Concrete and Marble Effect - www.arpaindustriale.com

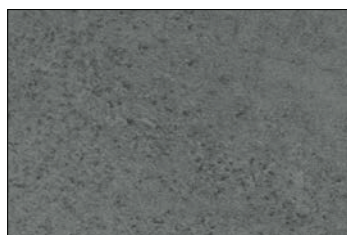

3192

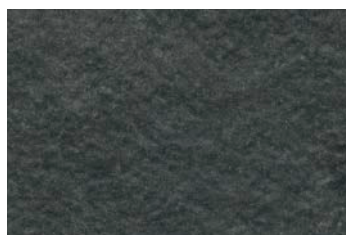

3349

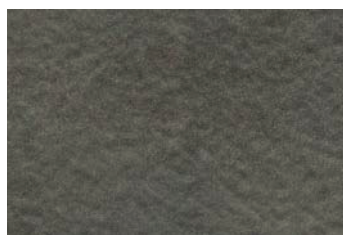

3276



3329



5547

Special Compactop Surface - Marble Effect - www.lamicolor.it



6075

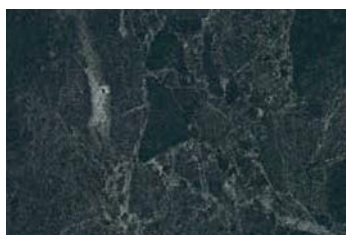

6076

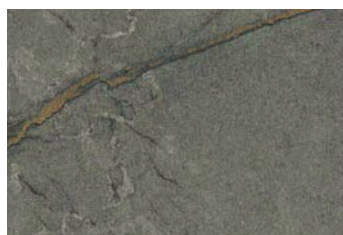

6089

Standard Laminated Surface



F



RN

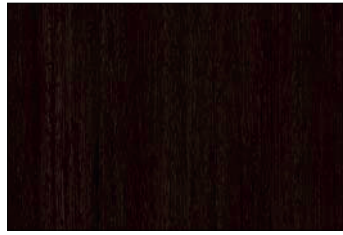

W



00



10

Special Laminated Surface - Wood Effect



B01



X41



61M



V32

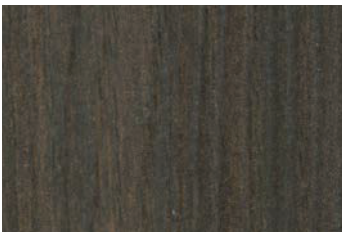

WGB

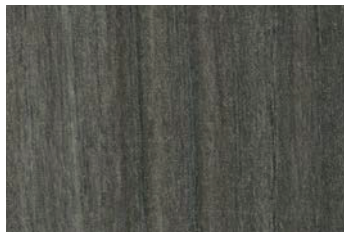

WG9

Special Laminated Surface - Fenix - www.fenixforinteriors.com

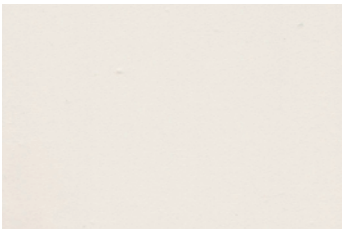

0029

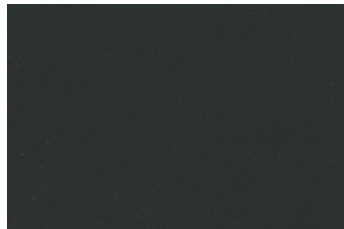

720

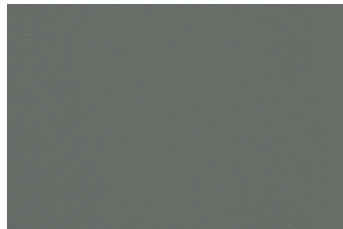

718



2630



2629



2628

COLOURS AND COVERINGS

COLORI E RIVESTIMENTI

Marble Surface

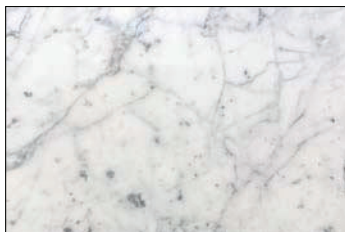

MBC - BIANCO CARRARA

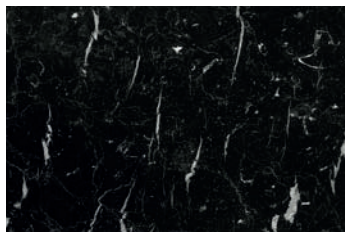

MNM - NERO MARQUINA

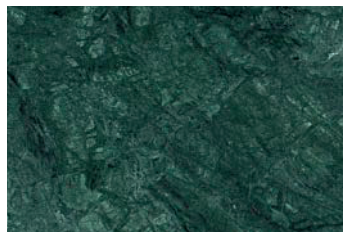

MVG - VERDE GUATEMALA

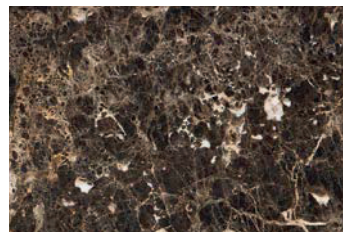

MED - EMPERADOR DARK

Porcelain Surface

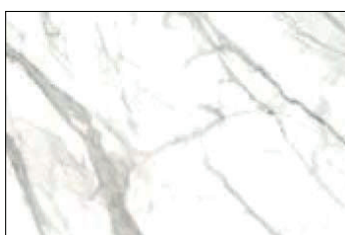

PCO - CALACATTA ORO

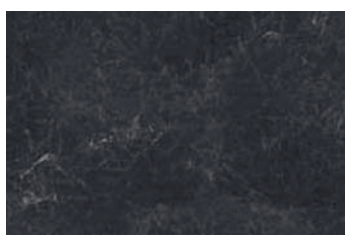

PNG - NERO GRECO

K King Fabric / Tessuto King

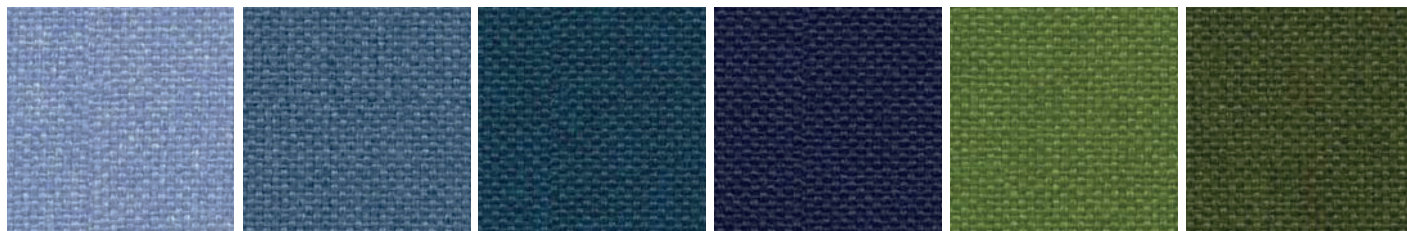

6001

6091

6034

6052

7019

7022

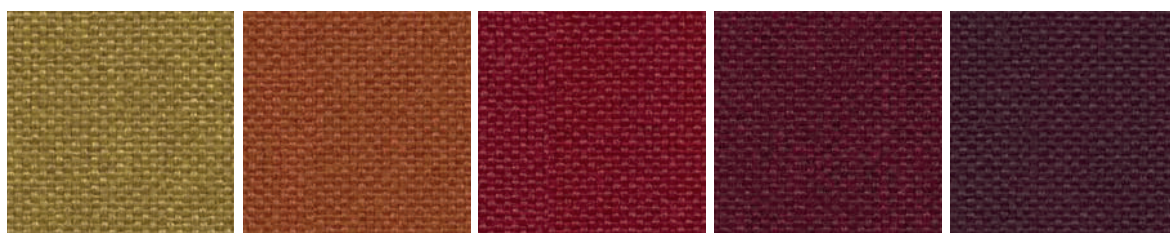

3030

3082

4021

4032

5001

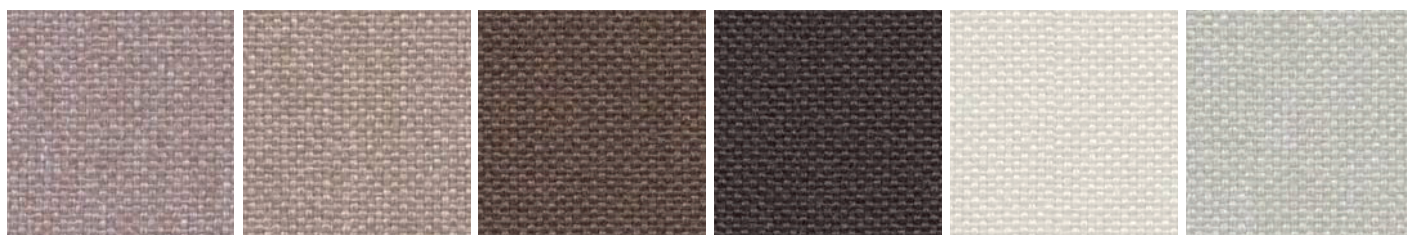

1033

1008

2003

2007

1012

1025

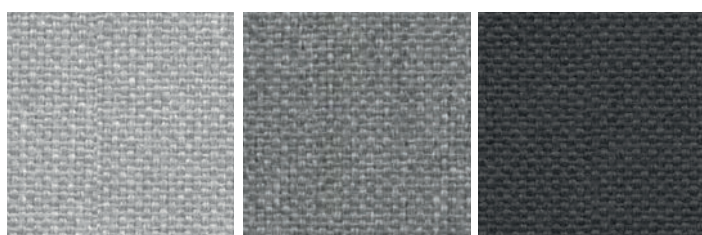

8032

8006

8011

- Composition: 100% POLYESTER - TREVIRA CS
- Abrasion: UNI EN ISO 12947-2 80.000 Cycle Martindale $\pm 10\%$
- Light Resistance-Xenotest: UNI EN ISO 105-B02 / 6 (tol from 5 to 8)
- Fire proof: UNI 9174 - 8456 Class C1, UNI 9175 Class 1, DIN 4102 Class B1, NF 92501-7 Class M1, NF D 60013, 11M (UNI 9175) Class AM18, EN 1021-1 & 2, BS Crib 5, BS 7176 Class Medium Hazard, EN 13773 Class 1, OENORM 3800-1 Class B1,Q1,TR1, California TB117, USA NFPA 701, USA NFPA 260, IMO A 652 (16) Part 8 Upholstery
- Maintenance: Standard 60° C cotton cycle.

Visit www.fidivi.com for complete colours range / Visionate la completa gamma colori su www.fidivi.com

COLOURS AND COVERINGS

COLORI E RIVESTIMENTI

L King L Fabric / Tessuto King L



6071

3090

4027

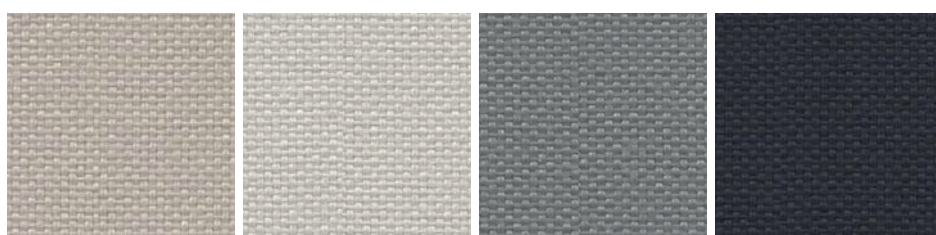

1010

1025

8014

8010

- Composition: 100% POLYESTER
- Abrasion: UNI EN ISO 12947/2 70.000 Cycle Martindale $\pm 10\%$
- Light Resistance-Xenotest: UNI EN ISO 105-B02 / 6 (tol from 5 to 8)
- Fire proof: UNI 9174 - 8456 Class C1, DIN 4102 Class B1, NF P 92501-7 Class M1, IMO Res. A652 (16), NF D 60013 Class AM18, EN 1021-1 & 2, BS 5852 part II Crib 5, BS 7176 Medium Hazard, ONORM B 3825-Onorm A 3800-1 Class B1-Q1-TR1, Euroclass EN 13501-1, EN 1021-1 & 2, 1IM (UNI 9175), California TB 117
- Maintenance: Use vacuum-cleaner, don't brush.

Visit www.fidivi.com for complete colours range / Visionate la completa gamma colori su www.fidivi.com

DK Kvadrat Fabric (Steelcut2) / Tessuto Kvadrat (Steelcut2)



835

760

780

950

975

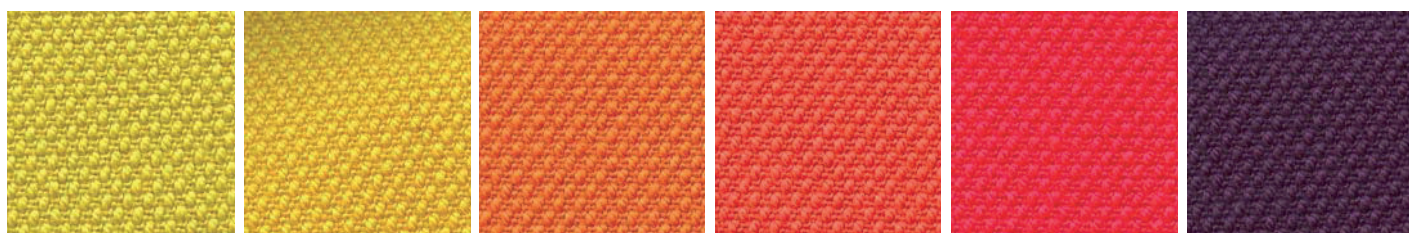

435

445

535

550

635

625



685

255

365

655

110

140

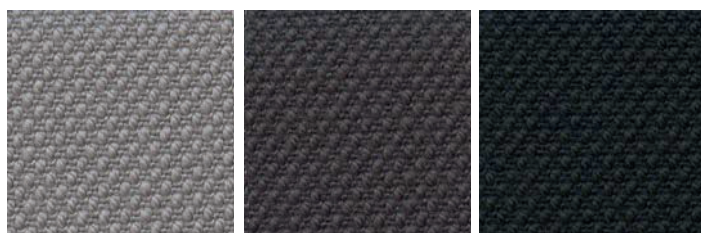

155

180

190

- Composition: 90% New wool worsted - 10% Nylon
- Abrasion: 100.000 Martindale rubs, EN ISO 12947
- Lightfastness: Note 5-7, ISO 105-B02
- AS/NZS 1530.3, BS 5852 crib 5 with treatment, BS 5852 part 1, IMO FTP Code 2010 Part 8, NF D 60 013, NFPA 260, SN 198 898 5.3 with treatment, UNI 9175 1IM, US Cal. Bull. 117-2013, EN 1021-1/2, AS/NZS 3837 class 2, ÖNORM B1/Q1, ASTM E84 Class A Unadhered, ASTM E84 Class B Adhered

Visit www.kvadrat.dk for complete colours range / Visionate la completa gamma colori su www.kvadrat.dk

COLOURS AND COVERINGS

COLORI E RIVESTIMENTI

DK Kvadrat Fabric (Remix3) / Tessuto Kvadrat (Remix3)



733

722

743

753

923

942

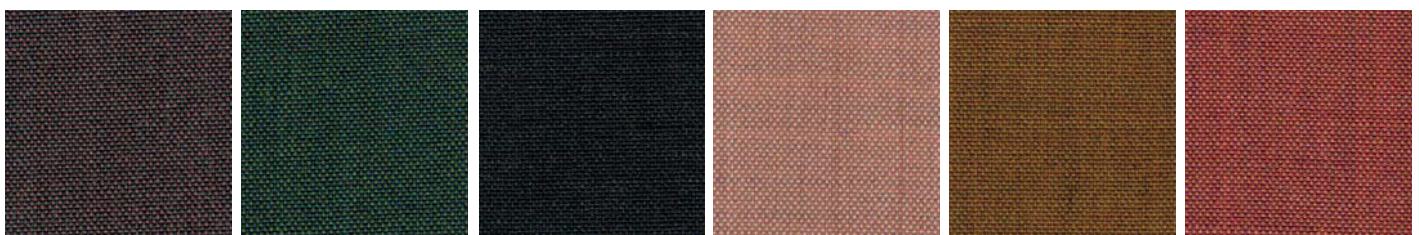

672

982

973

612

422

632



653

682

692

233

113

123



143

183

- Composition: 90% wool, 10% nylon
- Abrasion: Approximately 100.000 Martindale rubs, EN ISO 12947
- Lightfastness: Note 5-7, ISO 105-B02
- AS/NZS 1530.3, BS 5852 crib 5 with treatment, BS 5852 ignition source 3, BS 5852 part 1, IMO FTP Code 2010 Part 7 with treatment, IMO FTP Code 2010 Part 8, NF D 60 013, NFPA 260, SN 198 898 5.3 with treatment, UNI 9175 1IM, US Cal. Bull. 117-2013, EN 1021-1/2, AS/NZS 3837 class 2, ÖNORM B1/Q1, ASTM E84 Class A Unadhered, ASTM E84 Class A Adhered, GB 50222 B1 with treatment

Visit www.kvadrat.dk for complete colours range / Visionate la completa gamma colori su www.kvadrat.dk

S Superb Trevira Fabric / Tessuto Velvet-Velluto



5130

5127

5131

5140

5134

5135

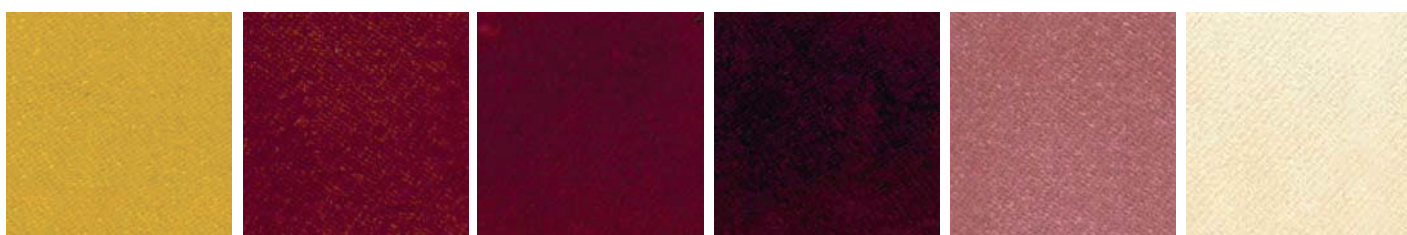

5106

5112

5118

5119

5114

5103



5144

5143

5149

5142

5145

5152

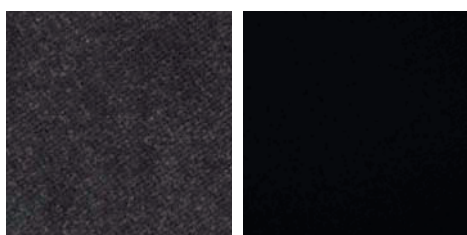

5151

5147

- Composition: 100% POLYESTER - TREVIRA CS
- Abrasion: UNI EN ISO 12947-2 100.000 Cycles
- Light Resistance-Xenotest: UNI EN ISO 105-B02 ≥ 5 Blue Scale
- Fire proof: UNI 8456 - 9174 classe 1, UNI 9175 classe 11M, EN 1021-1 EN 1021-2, BS 5852 crib 5, DIN 4102 B1, NF P 92 503-507 M1, TB 117:2013 UNI EN 13773:2004 classe 1, NFPA 701:2015
- Maintenance: Dust gently or pass the surface with a damp cloth.

Visit www.flukso.it for complete colours range / Visionate la completa gamma colori su www.flukso.it

COLOURS AND COVERINGS

COLORI E RIVESTIMENTI

B Blazer Fabric / Tessuto Blazer



CUZ2Z

CUZ1E

CUZ86

CUZ47

CUZ1T

CUZ2R

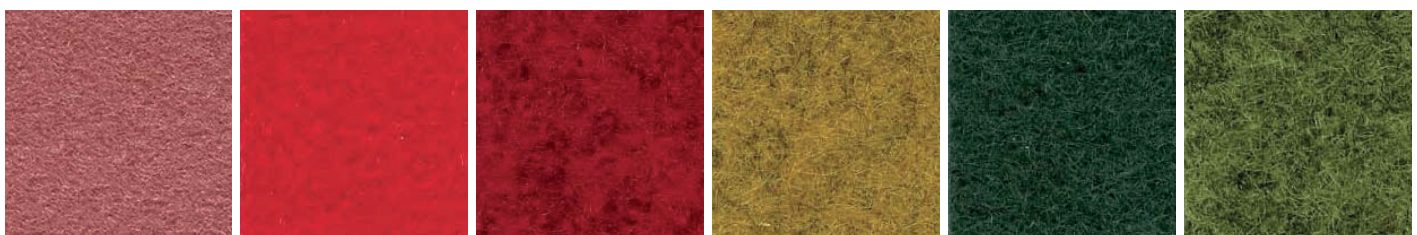

CUZ3D

CUZ18

CUZ63

CUZ82

CUZ1N

CUZ1K

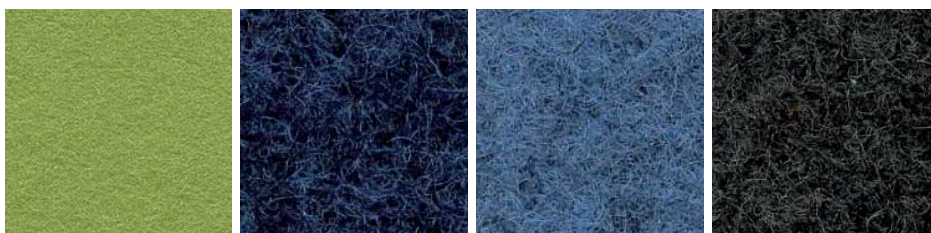

CUZ2X

CUZ62

CUZ1W

CUZ67

- Composition: 100% VIRGIN WOOL
- Abrasion: BS EN ISO 12497-2 65.000 Cycle Martindale
- Light Resistance-Xenotest: UNI EN ISO 105-B02 / 5
- Fire proof: BS EN 1021 Part 1, BS EN 1021 Part 2, BS 7176 Low Hazard, BS EN 13501-1:2007 Class D, NF D 60-013 AM18, UNI 9175:2010 Class 11M, BS476 part 7 Class 1, ONORM B 3825, IMOFTP Code (part 8)
- Maintenance: Use the vacuum-cleaner.

Visit www.camirafabrics.com for complete colours range / Visionate la completa gamma colori su www.camirafabrics.com

M Miki Fabric / Tessuto Miki

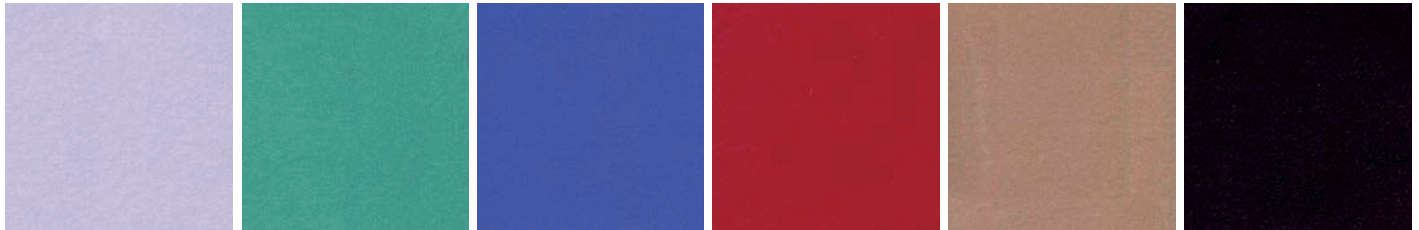

6445

6490

6713

6432

6334

NERO

- Composition: Composizione 100% PL 65/75 g/m² – Composition 100% PL 65/75 g/m²
- Light Resistance-Xenotest: UNI EN ISO 105-B02 / 01
- Maintenance: Dust with a soft and dry cloth.

COLOURS AND COVERINGS

COLORI E RIVESTIMENTI

FO Fortezza 93 Fabric / Tessuto Fortezza 93

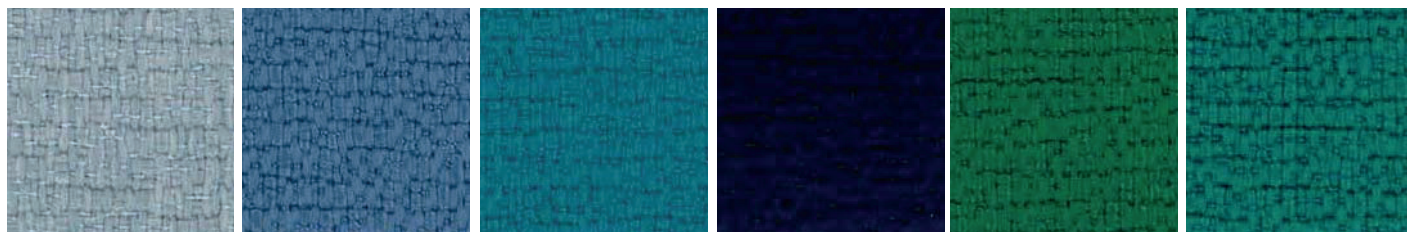

30-1

67-1

44-1

46-1

65-1

56-1

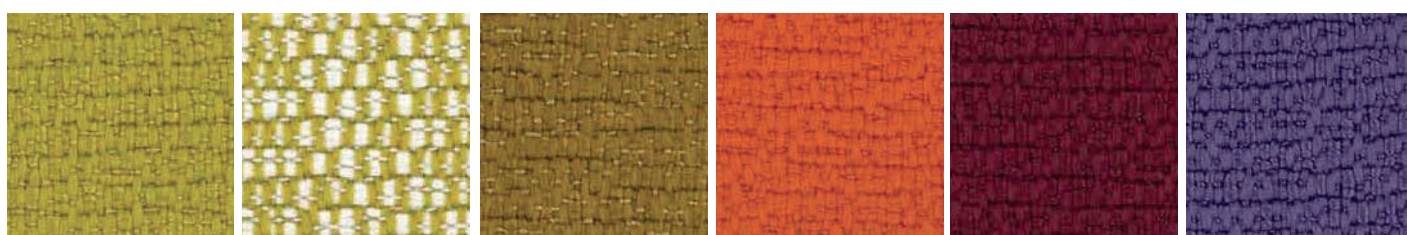

43-1

43-2

48-1

47-1

69-1

68-1

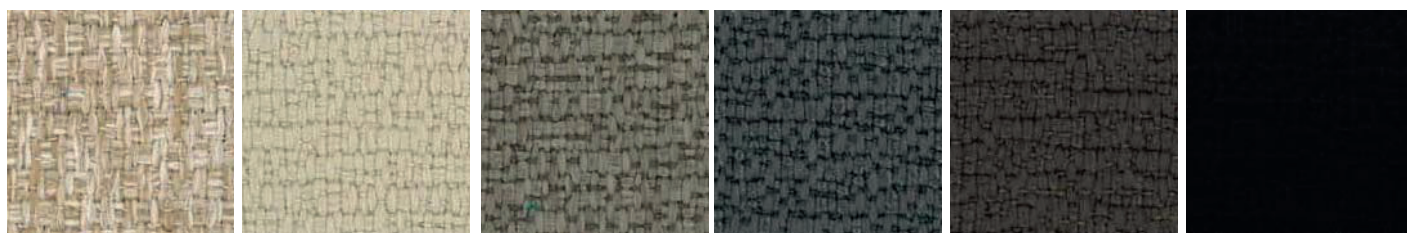

23-1

66-1

24-1

41-1

64-1

42-1

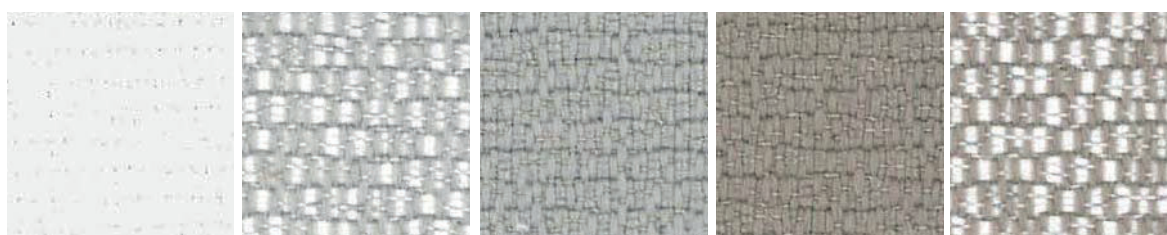

38-1

39-2

39-1

17-1

17-2

- Composition: 100% Polyolefinic
- Abrasion: UNI EN ISO 12947 35.000 rubs/cicli
- Seam slippage: BS 2543
- Pilling: UNI EN ISO 12945-2
- Colour fastness Dry Rubbing: UNI EN ISO 105-X12
- Colour fastness Wet Rubbing: UNI EN ISO 105-X12
- Light Fastness: UNI EN ISO 105-B02, UNI EN ISO 105-B04
- Colour Fastness to Sea Water: UNI EN ISO 105:E02:1996
- Colour Fastness to Chlorinated Water: UNI EN ISO 105:E03:2010
- Flammability: UNI 8456 - 9174 - CLASS 1 - ITALIAN FIRE SAFETY CLASSIFICATION - PASS, BS EN 1021.1:1994 - SOURCE 0 - CIGARETTE TEST - PASS, BS EN 1021.2:1994 - SOURCE 1 - BUTANE FLAME - PASS ON FR FOAM, T.B. 117 (2013): SECTION 1 POSITIVE, B1 ACCORDING TO DIN 4102, PART 1 (MAY 1998), NFPA 260:2013 - CLASS 1, IMO 2010 FTP CODE PART 8 - Resolution MSC 307(88) - Cigarette and Match Test, EN 13773 (2004) CLASS 1

Visit www.primafabrics.it for complete colours range / Visionate la completa gamma colori su www.primafabrics.it

GR Progarden Fabric / Tessuto Progarden

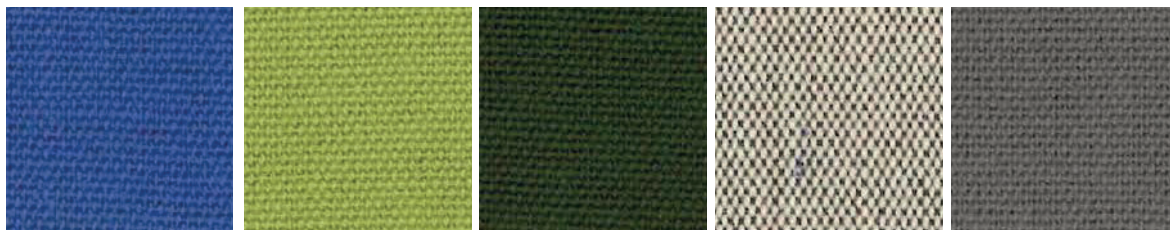

051
MEDITERRANEAN BLUE

026
PISTACHIO

028
OLIVE GREEN

012
LINEN

683
SLATE

- Composition: 100% yarn dyed acrylic
- Martindale (ISO 12947-2): 15.000 cycles
- Dimensional change after washing at 40°C and drying (warp/weft) (ISO 5077): ± 2%/0%
- Breaking strength (warp/weft) (ISO 13934-1): 200/70 daN
- Elongation at break (warp/weft) (ISO 13934-1): 25%/25%
- Tear strength (warp/weft) (ISO 13937-1): 7/3,7 daN
- Resistance to seam (warp/weft) (ISO 13935-1): 50/50 daN

- Air permeability (ISO 9237): 65 l/m²/s
- Finishing: Water repellent Teflon/Scotchgard treatment, dirt repellent and anti-mould treatment
- Spray Test (ISO 4920): 4 out of 5
- UV Colour fastness (ISO 105 B02): 5/8 out of 8
- Colour fastness to weather (ISO 105 B04): 5/8 out of 8
- Colour fastness after washing at 40°C (ISO 105 C06): 5 out of 5

Visit www.giovanardi.com for complete colours range / Visionate la completa gamma colori su www.giovanardi.com

SX Silvertex Fabric / Tessuto Silvertex

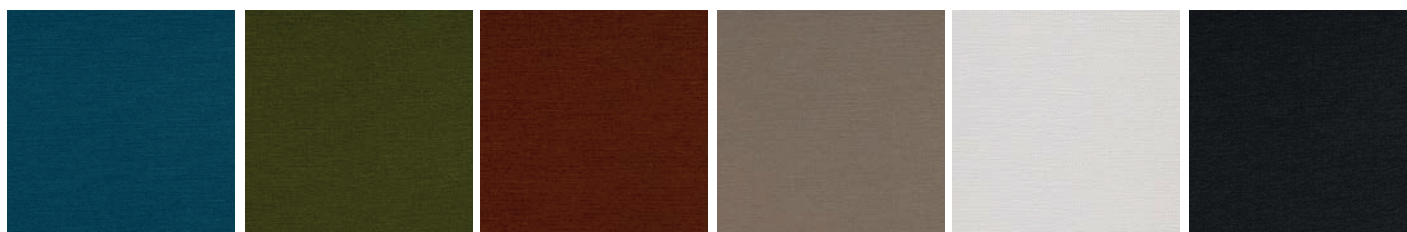

3066
BALTIC

5020
BASIL

1014
UMBER

0002
SANDSTONE

4004
ICE

4003
GRAPHITE

- Composition: 100% Vinyl / Polyester Backing
- Abrasion: >300.000 cycles Martindale (EN ISO 12947:1999 Part 2)
- UV Resistance: ISO 105 B04 ≥ 4/5 (Grey Scale), ISO 105 B02 ≥ 7/8 (Blue Wool Scale)
- Flame Retardancy: EU: EN 1021 Part 1 & 2
- DE: DIN 4102 B2 ECE Regulation No.118:03 (R118.02 Annexes 6, 7 & 8), ES: UNE 23.727-90 1R/M.2, FR: NF P 92-503/M2, IT: UNI 9175 (1987) / UNI 9175/FA1 (1994)
- Classe 1.1M (UNO I EMME), AT: ÖNORM B 3825, Gruppe 1 - Schwerbrennbares Verhalten, AT: ÖNORM A 3800 Teil 1, Qualmbildungsklasse Q1 - schwachqualmend, IMO FTP 2010
- Code MSC.307 (88) Part 8 3.1 & 3.2, (MED) Marine Equipment Directive (in its current valid version), EN 71-2:2006+A1:2007 - Safety of Toys - Parte 2: Flammability, US: CAL TB 117-2013, Section E, FMVSS 302, FAR 25/853

Visit www.spradling.eu for complete colours range / Visionate la completa gamma colori su www.spradling.eu

COLOURS AND COVERINGS

COLORI E RIVESTIMENTI

R Mesh Fabric / Tessuto Rete

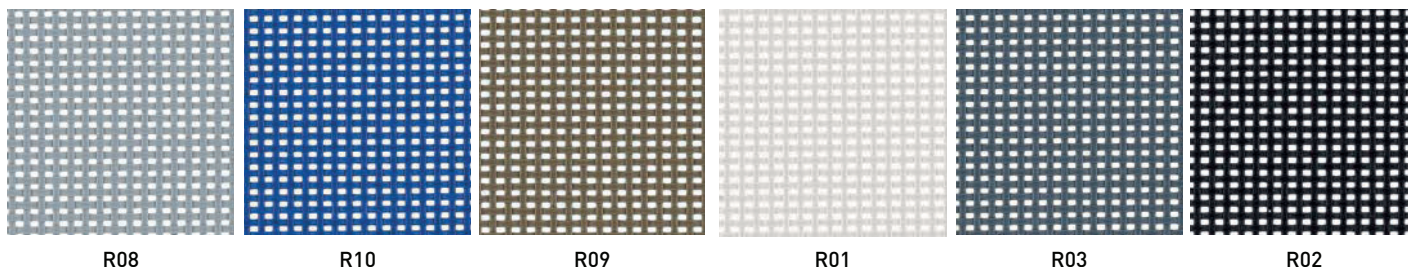

- Composition: Polyvinyl 70% - Polyester 30%
- Warp Tensile Strength: 310Kg/5cm
- Weft Tensile Strength: 270Kg/5cm
- Fire retardant on request

Visit www.plastitex.com for complete colours range / Visionate la completa gamma colori su www.plastitex.com

MG Maglia Vinyl Fabric / Tessuto Maglia Vinile

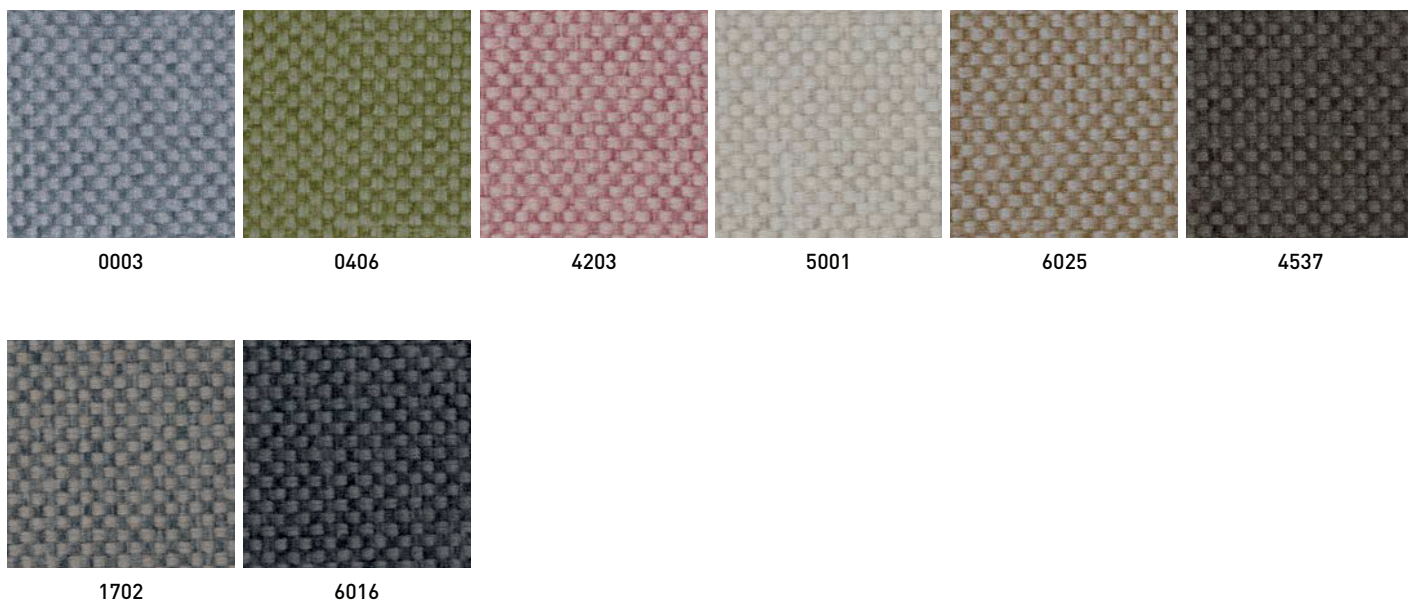

- Composition: Vynil 100%
- Abrasion: >100.000 cycles Martindale (EN ISO 12947:1999 Part 2)
- Fire Proof: EN 1021 Part 1 & 2, UNE 23.727-90 1R/M.2, NF P 92-503/M2, DIN 4102 B2, UNI 9175 (1987) / UNI 9175/FA1 (1994) Classe 1.1M (UNO I EMME), ÖNORM B 3825, Gruppe 1 - Schwerbrennbares Verhalten, ÖNORM A 3800 Teil 1, Qualmbildungsklasse Q1 - schwachqualmend, IMO FTP 2010 Code MSC.307 (88) Part 8 3.1 & 3.2, FMVSS 302, US: FAR 25/853, (MED) Marine Equipment Directive (in its current valid version), ECE R118.02 (replaces Directive 95/28/CE) Annexes 6, 7 & 8, EN 71-2:2006+A1:2007 - Safety of Toys - Parte 2: Flammability, CAL TB 117-2013, Section E
- Light Resistance: UV-Resistance XENOTEST DIN 54004/ NTC 1479

Visit www.spradling.eu for complete colours range / Visionate la completa gamma colori su www.spradling.eu

E Simil leather Aurea / Ecopelle Aurea

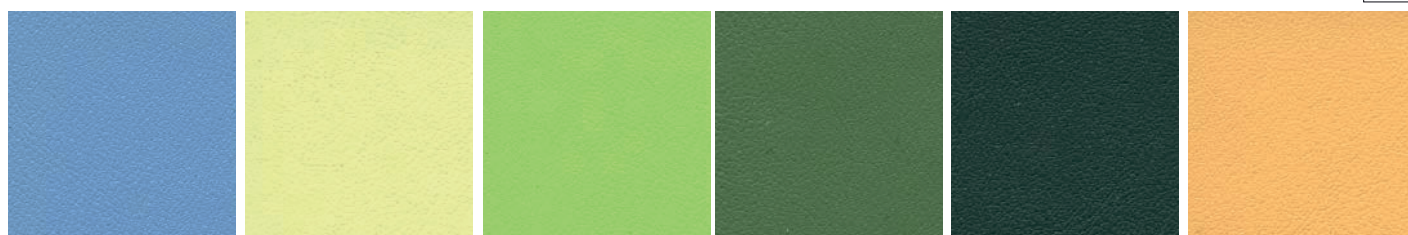

23

7

14

15

16

8



9

10

17

19

21

11



2

3

5

6

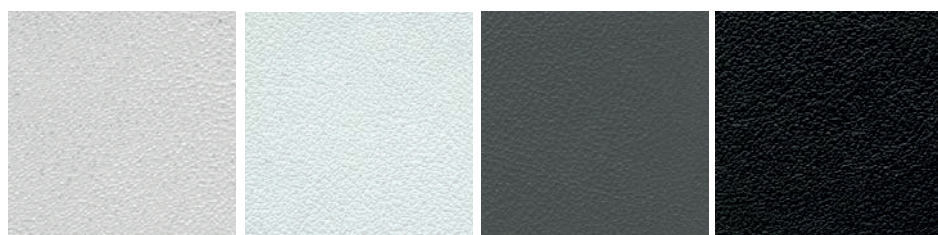

1

22

28

26

- Composition: 72% PVC - 3% PU - 25% COTTON
- Abrasion: EN ISO 5470-2 100.000 Cycle Martindale
- Light Resistance-Xenotest: UNI EN ISO 105-B02 / 6
- Fire proof: UNI 9175 classe 1IM, EN 1021-1, EN 1021-2, BS 5852-1 cigarette test, BS 5852-1 match test
BS 5852 crib 5, TB 117:2013, IMO res. A.652(16)
- Maintenance: Dust gently or pass the surface with a damp cloth.

Visit www.flukso.it for complete colours range / Visionate la completa gamma colori su www.flukso.it

COLOURS AND COVERINGS

COLORI E RIVESTIMENTI

C Leather / Cuoio

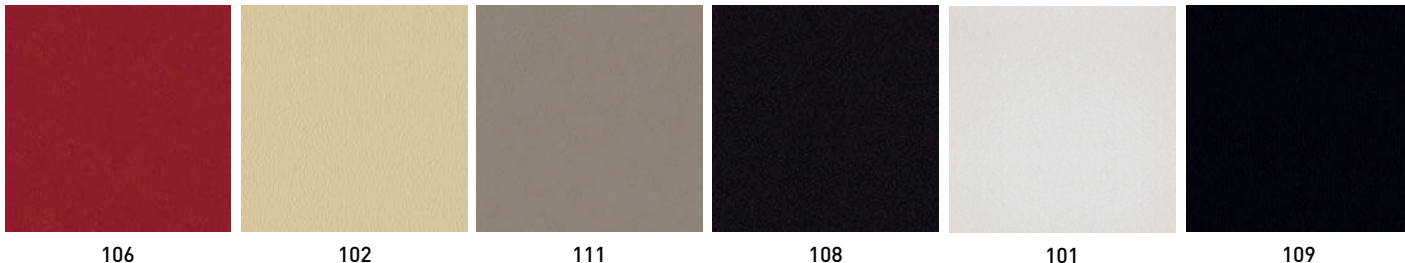

- Composition: 100% Grain Leather, Italian tannery
- Light Resistance: IUF/101
- Fire proof: CAL TB 117-00, Section E -part 1; BS 5852/90 section 4 (CRIB 5); UNI 91/75 Classe 2IM
- Maintenance: Dust gently or pass the surface with a damp cloth.

P Leather / Pelle

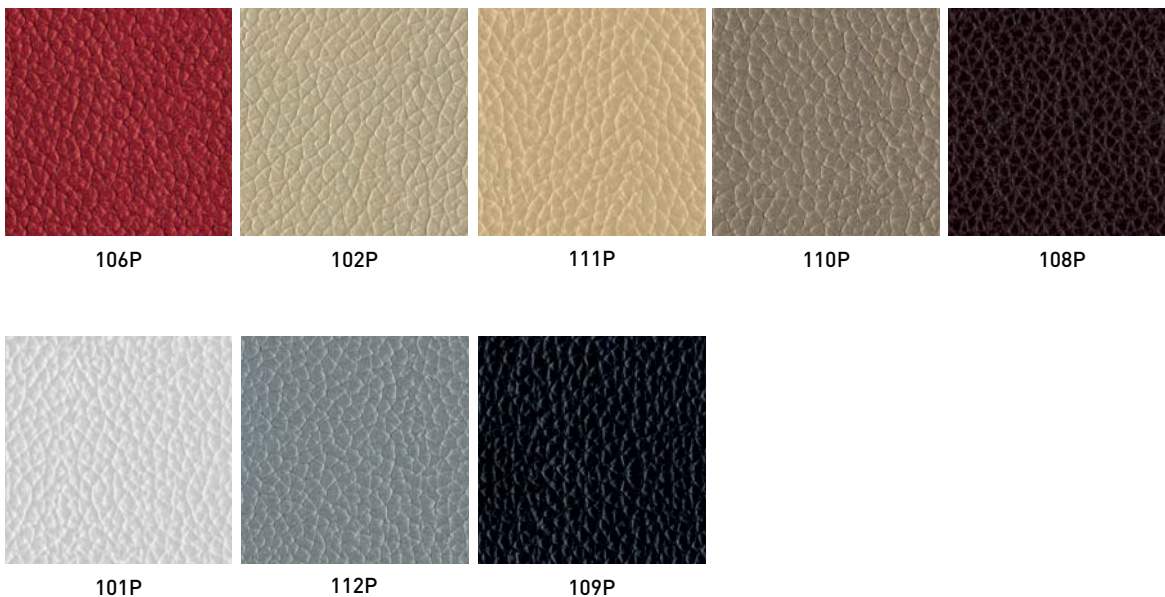

- Composition: 100% Top Grain Leather, Italian tannery
- Light Resistance-Xenotest: UNI EN ISO 105-B02 / 6
- Fire proof: BS EN 1021 Part 1, BS 1021 Part 2, BS 5852 Part 2 (with special fire-retardant padding)
- Maintenance: Dust with a soft and dry cloth.

